

RADIO'S LIVEST MAGAZINE

OVER 175 ILLUSTRATIONS

# Radio-Craft

1938

HUGO GERNSBACK EDITOR

SPECIAL  
RADIO  
SERVICE  
NUMBER

July  
25 Cents  
in United States  
and Canada

New  
RADIO SERVICE "CAR"

See Page 13



Radio Creates New Fashion Patterns! — NEW! . . . An Acoustic "Magnifier"  
Europe's Radio War — Making a Hi-Fi Tuner — Servicing A. C. - D. C. Sets

OVER 50,000 RADIO MEN READ RADIO-CRAFT MONTHLY



## The Best Known Name and the Oldest Trademark in the Business

CAPITALIZE on the definite sales advantages of the RCA Victor name and famous trademark.

Authorized RCA Victor Radio Tube franchises are available only through RCA Victor Instrument Distributors.

*RCA presents the "Magic Key" every Sunday, 2 to 3 P. M., E. D. S. T., on the NBC Blue Network.*



# **RCA Victor** RADIO TUBES

RCA MANUFACTURING CO., INC., CAMDEN, N. J. • A Service of the Radio Corporation of America



*I jumped from \$18 a week to \$50*  
*-- a Free Book started me toward this*  
**GOOD PAY IN RADIO**

**HERE'S**  
*How it*  
*Happened*  
 by S. J. E.  
 (NAME AND ADDRESS  
 SENT UPON REQUEST)



"I had an \$18 a week job in a shoe factory. I'd probably be at it today if I hadn't read about the opportunities in Radio and started training at home for them."



"The training National Radio Institute gave me was so practical I was soon ready to make \$5, \$10, \$15 a week in spare time servicing Radio sets."

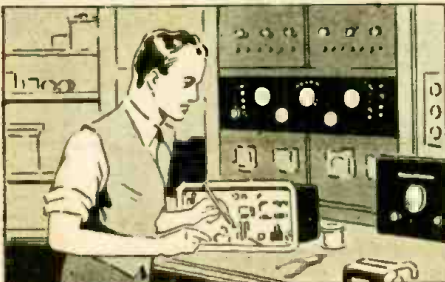

"When I finished training I accepted a job as serviceman with a Radio store. In three weeks I was made service manager at more than twice what I earned in the shoe factory."

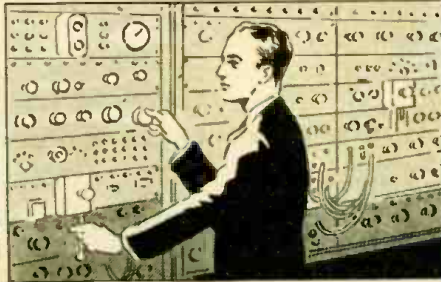

"Eight months later N. R. I. Employment Department sent me to Station KWUR as a Radio operator. Now I am Radio Engineer at Station WSUL. I am also connected with Television Station W9XK."



"N. R. I. Training took me out of a low-pay shoe factory job and put me into Radio at good pay. Radio is growing fast. The field is wide open to properly trained men."



*Find out today* how I Train You at Home  
**to BE A RADIO EXPERT**

J. E. SMITH, President  
 National Radio Institute  
 Established 1914.

**Many Make \$30, \$50, \$75 a Week**

Do you too want a better job? Do you too want to make more money? Radio offers many spare time and full time opportunities for good pay and more opportunities will come with Television.

**Get Ready Now For Jobs Like These**  
 Broadcasting stations employ engineers, operators, station managers and pay up to \$5,000 a year. Spare time Radio set servicing pays many \$200 to \$500 a year—full time servicing jobs pay many \$30, \$50, \$75 a week. Many Radio Experts are operating full or part time Radio businesses. Radio manufacturers and jobbers employ testers, inspectors, foremen, engineers, servicemen, paying up to \$6,000 a year. Radio operators on ships get good pay. see the world. Automobile, police, aviation, commercial Radio, loud speaker systems, offer good opportunities now and for the future. Television promises good jobs soon. Men I trained have good jobs in these branches of Radio.

**Many Make \$5, \$10, \$15 a Week Extra in Spare Time While Learning**

The day you enroll I start sending you Extra Money Job Sheets. They show you how to do Radio repair jobs; how to cash in quickly. Throughout your training I send plans and ideas that made good spare time money—from \$200 to \$500 a year—for hundreds of fellows. I send special Radio equipment, give you practical Radio experience—show how to conduct experiments, build circuits illustrating important Radio principles.

**I Also Give You This Professional Servicing Instrument as part of My Training**

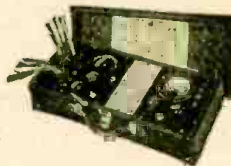

Here is the instrument every Radio expert needs and wants—an All-Wave, All-Purpose, Set Servicing Instrument. It contains everything necessary to measure A.C. and D.C. voltages and current; to test tubes, resistance; adjust and align any set, old or new. It satisfies your needs for professional servicing after you graduate—can help you make extra money servicing sets while learning.

**Find Out What Radio and Television Offer**  
 Mail the coupon now for my book, "Rich Rewards in Radio" and a sample lesson. They're free to any fellow over 16 years old. My book points out Radio's spare time and full time opportunities, also those coming in Television; tells about my Training in Radio and Television; shows you 131 letters from men I trained, shows what they are doing, earning; shows my Money Back Agreement. MAIL COUPON in an envelope, or paste on penny post card—NOW!

**J. E. SMITH,**  
 President,  
 National Radio Institute,  
 Dept. 8GX  
 Washington, D. C.



**J. E. SMITH, President, National Radio Institute,**  
 Dept. 8GX, Washington, D. C.

Dear Mr. Smith: Without obligation, send me free a Sample Lesson and your 64-page Book, "Rich Rewards in Radio," telling about spare time and full time Radio opportunities, and how I can train for them at home in spare time. (Please write plainly.)

Name ..... Age .....

Address .....

City ..... State ..... 14x1

Please Say That You Saw It in RADIO-CRAFT



HUGO GERNSBACK, Editor-in-Chief  
 N. H. LESSEM Associate Editor  
 R. D. WASHBURN, Managing Editor  
 ROBERT EICHBERG Associate Editor

## CONTENTS — JULY 1938, ISSUE

Volume X Number 1

Editorial: <i>Service</i> in Radio Servicing.....Hugo Gernsback	5
The Radio Month in Review.....	6
Radio in Pictures.....	8
Europe's Undeclared Radio War.....Michael Norton	9
Radio Creates Amazing Fashion Patterns .....Andrew Halbran and Robert Eichberg	10
Television Without Scanning?.....U. A. Sanabria	12
New Radio Service "Car".....G. E. DeNike	13
America's Radio Colossus.....	13
Servicing Universal A.C.-D.C. Receivers .....J. B. Straughn	14
Service Men!—Repair Your Customers' Sets "Better Than New"!.....George W. Halder	16
Servicing Pushbutton Tuning Systems—Part II .....Charles Sicuranza	18
New Circuits in Modern Radio Receivers—No. 10 .....F. L. Sprayberry	20
Modifying Older Sets to Receive the 4 High-Fidelity Stations.....Robert Cobaugh	21
How to Make a High-Fidelity Tuner.....C. W. Palmer	22
"Bi-Fonic" Sound Magnifier.....Robert Livingood	24
Matching Loudspeakers to Tapped Transformers .....A. Coblenz	26

Unified P.A. Equipment.....Harry Paro	28
Wax & Oil Condensers in Radio Service Work .....William Bailey	28
Operating Notes.....	29
Useful Circuit Ideas.....	30
A Wired-Radio "Nursemaid".....	31
Introducing—A 5-Meter Converter.....	31
The Latest Radio Equipment.....	32

### RADIO SERVICE DATA SHEETS:

No. 229 — Motorola Model 8-80 (Golden Voice) Car-Radio .....	36
No. 230—Ditto (continued) .....	37
Servicing Questions & Answers.....	35
Radio Wittiquiz.....	35
The First 10 Steps in Radio Servicing.....	49
Hum in Public Address Installations.....	53
Man Still Champion of the Air.....Dr. Irving Langmuir	60
Looking Ahead to Television Occupations .....Dr. Alfred N. Goldsmith	61
Book Reviews .....	63

## NEXT MONTH— TELEVISION NUMBER

Television is now undergoing its final polishing stage prior to its presentation to the public in workable form. Regular transmission schedules have just been announced by NBC; August *Radio-Craft* will help you keep abreast of these new and important developments.

Service Men, public-address specialists, radio set builders and beginners also will find in August *Radio-Craft* many valuable articles to their individual liking.

Published by Radcraft Publications, Inc. Publication office: 29 Worthington Street, Springfield, Mass. Editorial and Advertising Offices: 99 Hudson Street, New York City. Chicago Advertising Office: RADIO-CRAFT, 520 North Michigan Avenue, Chicago, Ill.

#### Foreign Agents:

London—Gorrings's American News Agency, 9A Green St., Leicester Square, W. C. 2, England.  
 Paris—Messageries Dawson, 4 Rue Faubourg, Poissonniere, France.  
 Melbourne—McGill's Agency, 179 Elizabeth St., Australia.  
 Dunedin—James Johnston, Ltd., New Zealand.

RADIO-CRAFT is published monthly, on the first of the month preceding that of date; subscription price is \$2.50 per year in U. S. and Canada. (In foreign countries, \$3.00 a year to cover additional postage.) Entered at the post office at Springfield as second-class matter under the act of March 3, 1879.

Text and illustrations of this magazine are copyright and must not be reproduced without permission of the copyright owners.

Copyright 1938 Radcraft Publications, Inc.

# TRAIN FOR RADIO IN 12 WEEKS

## BY MY QUICK, EASY "LEARN BY DOING" METHOD



Prepare today to enter a real money-making field by my quick, easy way to learn Radio. Here in my school you are trained in 12 weeks for your start for a better job and a real future. You do actual work on a great outlay of Radio equipment. The remarkable "Learn-By-Doing" methods used in the great Coyne Shops train you in Radio, Television and sound equipment servicing. Not by books . . . Not by Correspondence . . . But all under the individual guidance of skilled instructors, and only on similar kind of work you will meet out on a real job. My methods make it easy to learn—First you are told how to do a thing—then you are shown how to do it—then you do the work yourself. WHERE ELSE CAN YOU FIND SO QUICK AND EASY A WAY TO GET PRACTICAL TRAINING IN THIS GIANT INDUSTRY?

# I'LL FINANCE YOUR TRAINING

**DON'T LET LACK OF MONEY** keep you from sending in the Coupon TODAY. Learn how you can get training first and take more than a year to pay for it after graduation. Make your first payment 60 days after your regular 12 weeks' training period ends. Then take over a year to pay the balance of your tuition in easy monthly payments. Hundreds of ambitious fellows have used this method to get Coyne Training. **FILL IN THE COUPON AND MAIL IT TODAY.** It will bring you the details of this amazingly quick and easy way to get your start towards a good pay job.



*H. C. Lewis*

### Radio—Television—Sound Equipment

Your training at Coyne is in wonderful, modern daylight shops on the finest kind of RADIO, TELEVISION and SOUND EQUIPMENT. Television is sure to come as a commercial industry, whether this year or next. Talking Picture and Public Address Systems offer opportunities for the trained man. Everything possible has been done to make your stay at Coyne happy and healthful as well as profitable.

### Electric Refrigeration Training Included at No Extra Cost

This combination Training (Radio and Refrigeration) can be of great value to you. Whether you go into business for yourself or get a job working for a Radio Sales and Service organization, the fact that you are trained in servicing Electric Refrigerators should be profitable to you. Many Radio Manufacturers also make Electric Refrigerators and men with this combination training are much more valuable to these employers. You can NOW get this training without extra cost.

### No Advanced Education or Previous Experience Needed

If you can read and write simple English and are ambitious you can be trained the Coyne way—by actual experience on a wide variety of up-to-date Superheterodyne sets, oscillators, analyzers, and test instruments. You learn how to operate television receiving and transmitting equipment and how to install, test and service public address systems and sound picture equipment. Coyne training also helps prepare you to qualify for a government license examination as Amateur Broadcast or Telegraph Radio Operator and to know Code and Department of Commerce rules. Send coupon for all details.

### Part Time Work While Learning Employment Service after Graduation

If you need part time work to help pay living expenses while training, my Employment Department will help you get it. They will also give you Lifetime Employment Service after you graduate.

### Mail Coupon Today I'll Send You All the Facts

Get the new "Coyne Opportunity Catalog," giving all facts about Coyne Training. Photographs of Shops showing students at work on modern radio equipment under the personal supervision of Coyne Expert Instructors. Also details of my Part Time Employment Offer, Pay After Graduation Plan and Graduate Employment Service. Yours without cost. Simply Mail the Coupon.



**H. C. LEWIS, President RADIO DIVISION Founded 1899**  
**COYNE ELECTRICAL SCHOOL**  
**500 S. Paulina St., Dept. B8-8H Chicago, Ill.**

NAME.....AGE.....  
 ADDRESS.....  
 CITY.....STATE.....

Please Say That You Saw It in RADIO-CRAFT

# A New Policy!

## FREE INSPECTION PLAN

You can buy any Gernsback Manual on Three Days' Approval

Perhaps you're new in Radio—or probably, in previous years you missed one of the Gernsback OFFICIAL RADIO SERVICE MANUALS. This is your opportunity to buy any edition you might need—get it in a way differently than ever before offered. Under a new policy—FREE INSPECTION PLAN—you can buy any Gernsback Manual on Three Days' Approval. There are thirteen Manuals and books from which to choose—every man in Radio should take advantage of this privilege.

### Here Is How It's Done!

Order any GERNSBACK MANUAL illustrated and described on this page—the publishers will ship it to you immediately POSTPAID. When it reaches you, inspect its contents. If, after three days' inspection, you decide to keep the Manual, mail your remittance to the publishers. If the volume proves unsuitable, return it postpaid.

This plan is simple—there's no mystery or red tape—it gives you every opportunity to inspect the Manual of your selection. It costs you only a few cents return postage if you decide not to keep it.

### Latest Volume 7 Manual Included

Volume 7 of the OFFICIAL RADIO SERVICE MANUAL—the edition which stamped the Radio industry this past year because it was published in a new way—in twelve monthly installments, is included under this new policy. This volume is now complete—twelve installments, totaling 1,800 pages, are bound in a hardcover binder and just packed with information you need today—and in the years to come. The coupon below gives you the privilege of inspecting this Manual also before you buy it.



#### ★ VOLUME 7 ★

Newest of GERNSBACK MANUALS, contains schematic diagrams and service data on 1936-37-38 receivers. More up-to-date than any service guide published, 1,800 pages of material which radio men use every day. Wiring diagrams of over 1,200 different manufactured sets. Over 3,000 different illustrations. Bound in hard, loose-leaf covers—mechanism permits pages to be removed and replaced. Size—9 x 12 inches.

PRICE \$10.00

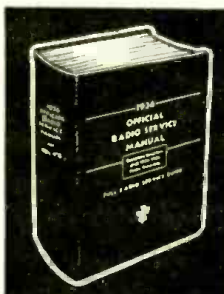

#### ★ 1936 MANUAL ★

Contains 1,200 pages (over 2,000 illustrations) packed with service data of 1935-36-37 sets. Diagrams of over 1,500 receivers. Shows speaker connections, power transformer connections. Alignment Procedure included with diagrams. Operating voltages for over 80% of sets are recorded. Assembly diagrams show relationship of separate units to each other. Size—9 x 12 inches; hard cover, looseleaf binder.

PRICE \$7.00

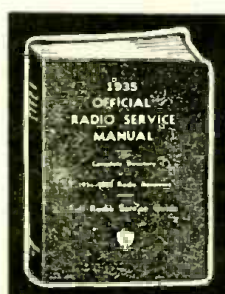

#### ★ 1935 MANUAL ★

An authentic radio service guide of over 1,000 pages with more than 3,000 illustrations—contains schematic diagrams of 1934-35 receivers. Features many old sets never previously described, early all-wave and short-wave sets, auto-radios, midset and clear-box receivers. Includes data on P.A. amplifiers, servicing instruments, tube information and FREE QUESTION AND ANSWER SERVICE. Size—9 x 12 inches; flexible, looseleaf covers.

PRICE \$7.00

★ 1935 AUTO-RADIO MANUAL ★  
OVER 240 PAGES  
OVER 500 ILLUSTRATIONS  
Looseleaf Binder—Flexible Covers  
PRICE \$2.50



#### ★ 1934 MANUAL ★

Contains over 400 pages—over 2,000 illustrations. The schematic diagrams cover 1933-34 receivers. Features voltage readings, I.F. transformer values in superhets, valuable tube data and FREE QUESTION AND ANSWER SERVICE. A handy index makes it easy to find any information on service problems. Master index includes diagrams published in previous MANUALS. Size—9 x 12 inches; flexible, looseleaf covers.

PRICE \$3.50

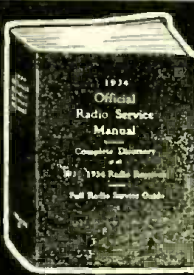

#### ★ 1933 MANUAL ★

This 700-page Manual, with over 2,000 illustrations, contains page after page of operating notes—schematics showing location of parts on chassis—values of I.F. peaks, resistors and condensers. A complete section on construction of various types of test equipment, plus money-making ideas for radio men. Includes auto-radio installation and servicing. Size—9 x 12 inches; flexible, looseleaf covers.

PRICE \$5.00

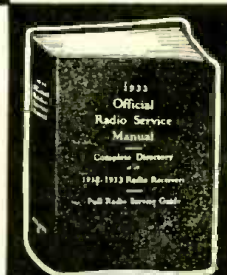

#### ★ 1932 MANUAL ★

This Manual contains a full radio service guide of 1931-32 receivers. With over 1,000 pages and over 2,000 illustrations, it features a step-by-step analysis in servicing a receiver—chart showing operation of vacuum tubes—schematic diagrams with color coding indicated—commercial short-wave receivers and adapters and servicing public address equipment. Size—9 x 12 inches; flexible, looseleaf covers.

PRICE \$5.00



#### ★ 1931 MANUAL ★

The first of the famous GERNSBACK MANUALS—contains all available wiring diagrams of nearly every receiver manufactured since 1927, and many prior to that year. This particular edition contains 650 pages (including supplements) with over 1,500 important diagrams. Most valuable radio men in the RADIO SERVICE COURSE published in this edition. Size—9x12 inches; flexible, looseleaf covers.

PRICE \$4.50 including supplements.



#### OFFICIAL RADIO SERVICE HANDBOOK

Here's the sensational book on servicing. Covers over 500 topics. Contains a special section of 250 pages of Operating Notes. The book covers: Circuit Theory and Analysis; Modern Servicing and Test Equipment; Practical Trouble Shooting; Specialized Receiver and Installation Data; Modernization and Conversion Data, etc. Over 1,000 pages—over 1,000 illustrations—hard covers. Size 6 x 9 inches.

PRICE \$4.00

### ● This Policy Includes —

OFFICIAL REFRIGERATION SERVICE MANUAL (Volume 1) — \$5.00  
OFFICIAL REFRIGERATION SERVICE MANUAL (Volume 2) — \$5.00  
OFFICIAL AIR CONDITIONING SERVICE MANUAL — \$5.00

### How To Get Any Manual You Need!

After you have definitely decided which Manual you want, fill in completely the coupon at the right. Clip it to your letterhead or paste on a penny post card and mail to the publishers. In a few days your Manual will reach you—Don't lose time—send coupon, TODAY, to

**RADCRAFT PUBLICATIONS, Inc.**  
99 Hudson Street New York, N. Y.

**RADCRAFT PUBLICATIONS, Inc.** RC-738  
99 Hudson Street, New York, N. Y.

Please send me, POSTPAID, ..... for three  
(Name of Manual or Book)

days' examination on approval. In three days I will remit to you the full cost of the Manual or book selected, or return the volume to you postpaid.

Name .....

Address .....

City ..... State .....

Name of company or employer .....  
(This offer is good only in continental United States.)

Please Say That You Saw It in RADIO-CRAFT



"Takes the Resistance out of Radio"

Editorial Offices: 99 Hudson St., New York, N. Y.

HUGO GERNSBACK, Editor

Vol. X, No. 1, July, 1938

## SERVICE IN RADIO SERVICING

An Editorial by HUGO GERNSBACK

In China, doctors, for untold ages, have been in the habit of collecting a fee for keeping patients free from sickness. In China you do not pay a doctor when you are ill.

This is excellent psychology not only from the doctor's viewpoint, but from the patient's as well, as no one likes to be sick. It is much better to pay a small fee every month or quarterly to a doctor who makes it his business to keep you well.

In the United States, it is the custom, with dentists, particularly good dentists, to send their patients an appointment card every 3 to 6 months for a general cleaning of the teeth. In doing so, the dentist keeps your teeth not only in good condition but he can discover the start of decaying teeth and fill them before the damage becomes more serious. This, too, is good business for the dentist and the patient because it saves the patient much expense in the end. It is an easy matter to fill a tooth that has just begun to decay. It is quite another matter when the decaying process has gone so far that the tooth becomes worthless and must come out. This means expensive bridgework, and special treatments compared to the trifling cost of filling the tooth at the time attention was first necessary.

Now, Radio Service should not be any different in principle than the two examples given. Up to very recently, Service Men have been extremely shortsighted in regard to their relationship with the people whose sets they service, and they are now paying the penalty of this shortsightedness caused by having the public mistrust the Service Man and his work. The public has come to realize that many Service Men have taken ruthless advantage of them and now the average non-technical radio set owner does not place too much confidence in radio repairmen.

Often when a Service Man was called in, he would immediately run up a bill of \$20 or more when there was really nothing wrong with the set except perhaps a loose connection or even such a trifling thing as a disconnected aerial binding post, yet the dishonest Service Man would tell the radio set owner that the transformer was burned out, new tubes were needed, etc. Of course after awhile the public became wise to such crude methods and the result was that in the end these radio Service Men were the chief sufferers themselves. What usually happened was that the Service Man who took advantage of radio set owners' ignorance, was never called back a second time and he eventually had to go out of business because he had no more customers left.

In Radio Servicing, as in any other business, it is always the Golden Rule that counts. No Service Man can expect to live and prosper if he does not use up-to-date methods and

give his customer a square deal. It is much better for the Service Man to make no money at all on the first transaction because in the end he will get much further with the radio set owner, once the customer finds out that the Service Man merits his confidence.

Applying the Chinese doctors' and dentists' methods to Radio Servicing, it is soon discovered that such methods will in the long run work out most advantageously to the Service Man. Suppose for instance that a Service Man has 100 customers or prospective customers on his list. It should not be too difficult for him to convince them that for a fee of from 50c to \$1 per month (depending upon the value of the set) the Service Man or his organization will keep the radio set in perfect working order for the duration of the service. In 9 out of 10 cases, with such a method the Service Man must be "in the money" because in the very nature of things, most repairs that come along are small and inconsequential. Even if a customer has a set that was entirely demolished by lightning, the Service Man could still repair or replace it because he would have had enough income to do so without any quibbling or fuss.

In a running business, it is the volume that counts as well as the law of averages. Out of 100 sets, few will need very extensive or expensive repairs during the course of a year. Of course with this method it is perfectly natural to find that once in a while a customer will take advantage of a Service Man, but again the law of averages works in favor of the radioman because people as a whole are honest in their dealings and the Service Man should experience little difficulty in this respect. Then also, and this is a big point, remember always that a Service Man has a tremendous advantage over the average salesman.

The average salesman has considerable difficulty in getting into people's homes whereas the Service Man is ACTUALLY INVITED into the home. Just imagine how a hard-working vacuum cleaner salesman would jump at such a chance to be invited by his customer, yet the Service Man never takes advantage of this great opportunity. It means that in a large proportion of calls the Service Man can sell the radio set owner many other things besides Radio Service. There are a host of electrical appliances which can be sold to such customers, but of course you must be prepared to show them manufacturers' literature or samples and this should not be a very difficult thing.

*In this manner the Service Man can double or triple his income, so why not try it? The Radio Servicing business is only what you make it. It is only "bad" if you make it so yourself.*

# THE RADIO MONTH

Radio is now such a vast and diversified art it becomes necessary for *Radio-Craft* to present a survey of important general-interest monthly developments.

## YOU CAN'T SAY THAT!

**T**HE censors and their proponents continued to struggle along, last month, losing out in these United States but booming blithely in Britain.

In the tight little isle, *Pearson's Weekly* patted itself gently upon the back, last month, because a radio announcer prefaced a program by saying that it was unsuitable for young children. A mother wrote in to comment upon this and to recall that the weekly had suggested some such sort of procedure. The B.B.C. also announced that its radio dramatization of "Dr. Caligari" would be similarly introduced. It's a nice little play—about a mad-house!

Here the estimable *Christian Science Monitor*, last month, praised Britain's defense of "helpless creatures—children for one class," and quotes a letter from President Byrd of the U. of Maryland, in which he threatens to throw away his 3 receivers if his two sons won't stop listening to blood-curdling programs. Other educators write similarly, one bewailing the fact that his young neglect their home-work for "the radio." No one mentions (and, possibly, rightly so) that persons who cannot control the actions of their own children might find it a bit difficult to control one of the country's major industries—and no one else seems to want to control it. Anyway, why not let the kids enjoy life? They're much safer getting their thrills in their own homes than they would be sneaking up a back alley with the "Ten Beautiful Art Studies Weekly" or a copy of "Sexy Stories."

But censorship has its opponents, too. One of these is the redoubtable Hugh Johnson, who last month went on to say that even the F.C. Commission's authority to decide whether stations are operating "in the public interest, con-

venience and necessity" gives it too much power over what may and what must not be said. William S. Paley, President of the C.B.S., widely famed as a public-spirited citizen, suggests that listeners cock a suspicious eye at all attempts to censor the medium which affords them so much entertainment.

The amount of entertainment is, according to Dr. Jay B. Nash, 150,000,000 listener-hours per day. The good Doctor, who is chairman of the Physical Education Department of New York University, last month declared, "It is the moronishness, the stupidity, the inactivity of it (radio), rather than the badness, that gives us the greatest concern." The Doctor is to be complimented upon having made a contribution to the nation's language, if not to its thought, for "moronity," not "moronishness," is the word given in our Unabridged.

## TELEVISION COMES ALONG

**T**ELEVISION progress is apparently similar to the movement of a glacier — irresistible, but awfully slow.

Best sign of last month was N.B.C.'s announcement of broadcasts to be run 5 hours weekly during the period of a month. These were planned to include thrice-weekly hours of stills and charts for engineers' check-ups, and twice-weekly evening hours of live talent and movie film. Pictures were to be 441 lines on 46.5 mc., with associated sound on 49.75 mc.

The next most important step of last month was the provision of a number of aliases for the cathode-ray and other tubes. Thus, a C.-R. tube used in an oscilloscope becomes an *Oscillotron*, while, if used in television, it changes its name to *Teletron*. An image emitter,



"WIRELESS" ON HORSEBACK. Lancashire mounted police now carry 6 lb. radio sets, by which they can conduct 2-way speech 2 to 5 miles. Orders can be handled between police planes and cars.

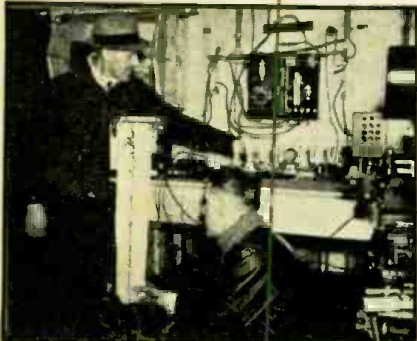

WINDS TO HELP RADIO PROGRAMS. Checking graphed performance of Bell Tel. wind-electric generator, atop Schooley's (N. J.) Mountain.



Four booster stations on Bell Tel.'s "Fourth Transcontinental Line" through the Southwest will each use a wind-electric generator to maintain power for the new "J" type carrier telephone lines which will have broadcast program facilities as well. A gasoline-operated generator will automatically take over if wind-power fails; while an automatic device signals nearest "inhabited" booster station in event of further failure. (Unit on test, above, is destined for Mohave Desert.)



RADIO "WALKERS." The first unit of a series of novel window displays supplied to tube dealers consists of 6 colorful, comic "walking" figures with bodies representing receiving and transmitting tubes, television tubes, etc.



# IN REVIEW

or tube which provides a standard video signal source as reported in April *Radio-Craft*, is a *Phasmajector* and an "electric eye" or PE. mosaic pick-up tube for use in television cameras is an *Electromalux*, and has nothing to do with refrigeration. The Du Mont Laboratories announced their adoption of these names.

In Australia, the editor of a Sydney radio weekly became quite enthusiastic over an announcement last month that John Logie Baird, television inventor, plans to erect a \$50,000 station there. His enthusiasm was not shared by Stuart F. Doyle, chairman of the Commonwealth Broadcasting Corporation, who stated that television programs in England are "anything but entertaining," and that the sales of *teleceivers* there are less than 10,000 per year. "Unquestionably," says Mr. Doyle, "television will be a most interesting development in the next few years, and it is up to some brilliant organizer to find a way of making it commercial."

E. K. Cohan, director of engineering for C.B.S., returned last month from a trip to England and remarked that British television was good, but that the public was only curious, rather than interested.

The reason for such insular apathy may be revealed in a discussion of television which took place in the House of Commons last month. Member White said that receivers cost too much; Member Simmons added that telly had not been developed "either geographically or technically," and that first-rate artists were not being televised, which meant that programs seemed amateurish. Member Morrison said that the service was being monopolized by London, and that it should be extended to Scotland, Wales and the Provinces.

Meanwhile Marconiphone last month developed a 37-tube teleceiver which uses a 3-inch projection tube, working at 20,000 volts, to project an 18-x-22-inch image on a screen. And the B.B.C. advanced plans to telecast the 1938 Oxford-Cambridge boat race and other



(Photo—British Broadcasting Corp.)  
TELEVISIONING THE BOAT RACES. Experience gained here, televising the annual Head of the River race between rowing clubs from London and elsewhere, was used to good advantage in later televising the Oxford vs. Cambridge boat race. Insert shows ads., reproduced by *Wireless Retailer and Broadcaster*, illustrating how the programs get a boost.

sporting events. Plans call for the use of mobile units.

In France, work was commenced last month on the installations of underground high-frequency cables, capable of carrying up to 4,000 kc. These cables will link Paris with Limoges, Bordeaux and Toulouse. They will carry television, radio broadcast and telephone conversations simultaneously.

## RADIO AND EDUCATION

CLEVELAND, Ohio, schools last month began work on a municipal school-of-the-air. The sum of \$42,000 has been allotted to this work, which will include special news broadcasts, broadcasts for children of pre-school age, dramatized school lessons, programs for parents, special events broadcasts, etc.

N. Y. University last month issued an announcement of a summer school to teach preparation and production of radio programs. Besides staging their own shows, students will visit N.B.C., C.B.S. and other studios, will hear lectures, etc. The best student programs will be aired.

(Continued on page 42)

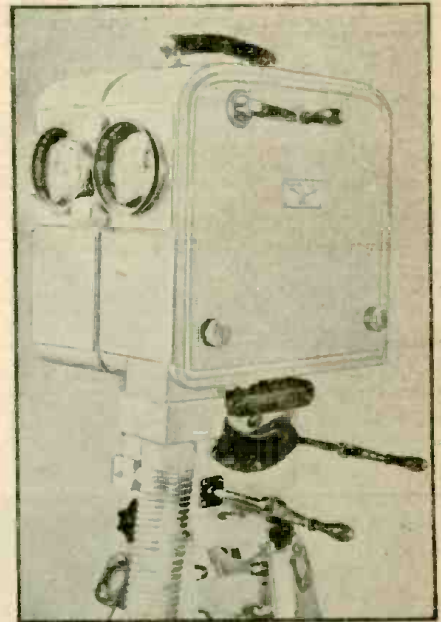

STUDIO-TYPE TELEVISION CAMERA. By utilizing the ultra-sensitive iconoscope as the pick-up tube, Fernseh, A. G. (Berlin, Ger.) produced a camera, for indoor television scenes, which measures only 17 x 12 x 8 ins. wide. The handle on the side of the device is used for focusing. Twin lenses include one lens for focusing; both are "optically coupled."

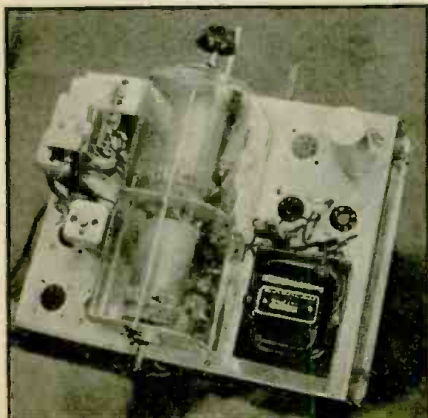

← NO CONDENSERS! Mr. Paul Ware's "inductance tuning system" (*Radio-Craft*, Feb., '38, "New Condenserless Tuning System Demonstrated!"), as a 2-gang, complete unit looks as shown at left.

→ NEWEST ROBOT. A "psycho-radio robot," as the awesome thing is called, is the device, shown at right, which was recently exhibited at the International Exhibition of Invention at Sheffield, England, last month. It answers questions and claims to read thoughts!

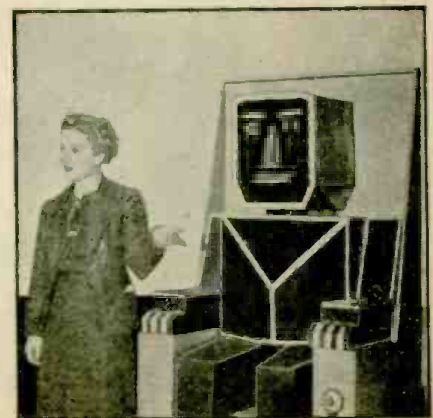

# RADIO IN PICTURES



(Photo—Sovfoto)



(Photo—Sovfoto)

## RADIO AFLOAT AT NORTH POLE

Above, and at upper-right, show part of Soviet Russia's 4-man expedition to the North Pole, on an ice floe; Icebreakers rescued the men last February (photos reached U.S.A. in April). Radio operator E. Krenkel is shown (above) inside his radio station; Reaching (upper-right) for a pedal on the sled-mounted power generator—the wind-driven power unit may be seen, partly, in background—for this "furthest North" radio station, is Ivan Papanin, "Hero of the U.S.S.R."

## \$35,000 SOUND DISPLAY ON WHEELS!

A 2-point exhibition tour, 7,000 miles, by 3 RCA officials. In a special Pullman car (A, below), started last month. Point 1: to show dealers the many markets for sound products; point 2: to spectacularly show architects, engineers, building owners, entertainment operators, industrial managers, and school administrators in 24 principal cities of the United States, the features of new sound equipment. In addition to living quarters, this "itinerant museum" sports a section (B) for demonstrating record and film sound and talkies equipment, interphones, school and other permanent sound systems; and a section (C) for showing portable sound equipment, various electronic devices, etc. On the observation platform are mounted mile-range loudspeakers (arrow, in A, indicates one of two) to serve up speech and music; same-type units are finding application, as suggested in past issues of *Radio-Craft*, in the direction of fire-fighters, ship-to-dock communication, and so on.

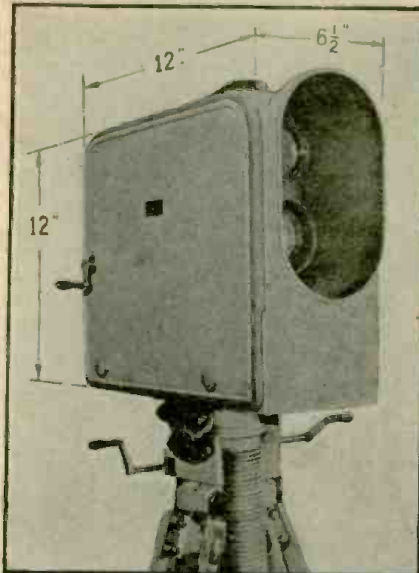

## TINY TELEVISION-NEWS CAMERA

We see, at left, how American engineering has helped perfect European television equipment; Zworykin's Iconoscope has been utilized to perfect a television pick-up camera only a foot square and a half-foot wide! The outdoor television-news reporter finds in this one case all the video equipment he requires, plus a built-in sunshade and dual-lens focusing device, all in a cast-aluminum case! (The sound pick-up apparatus, of course, is not included in this set-up.) A companion small-space television camera is illustrated on the preceding page, both cameras being a product of Fernseh, A.G. (Berlin, Germany). Note however that the studio-type camera is somewhat wider than the outdoor type, and unlike the latter its television and focusing lenses are mounted in a parallel plane.

## RESISTOR GENERATES INFRA-RED RAYS!

At lower-right you see how a resistor dutifully helps take its own picture in pitch-blackness! Illustration serves the dual purpose of demonstrating to experimenters how *infra-red rays* may easily be generated, and how well-made resistors will stand up under considerable overload. In the test, a 360-ohm Continental Carbon "Ultrawatt"-type resistor rated for a normal load of 10 watts was connected across 118 volts A.C.; and then suspended over the face of the voltmeter recording the line potential. An exposure of 30 mins. on hypersensitized *infra-red* negative material recorded the invisible rays radiated by the resistor (overloaded 386%), and their reflection from the face of the meter. (Do you remember?: April, '38 *Radio-Craft* showed how invisible *cathode rays* helped visualize electron flow; and the Sept., '36, issue showed how invisible *X-rays* made visible inside opaque containers, faulty wiring, defective components, etc.)

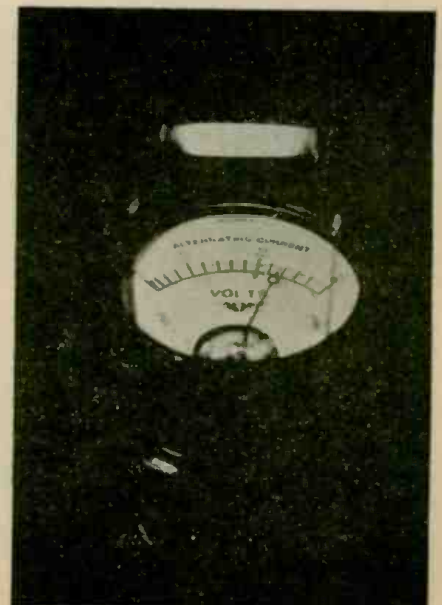
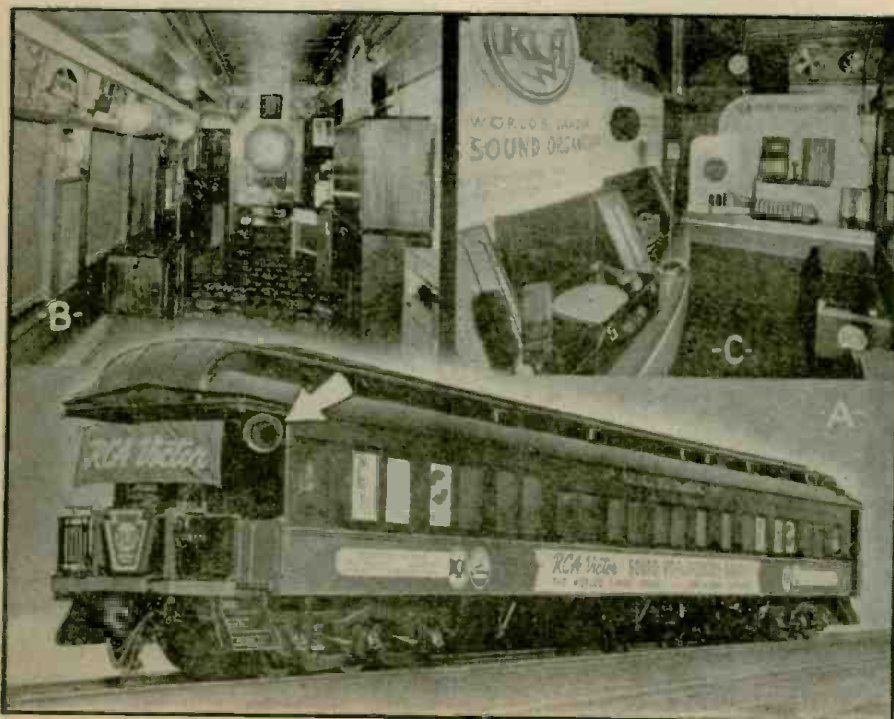

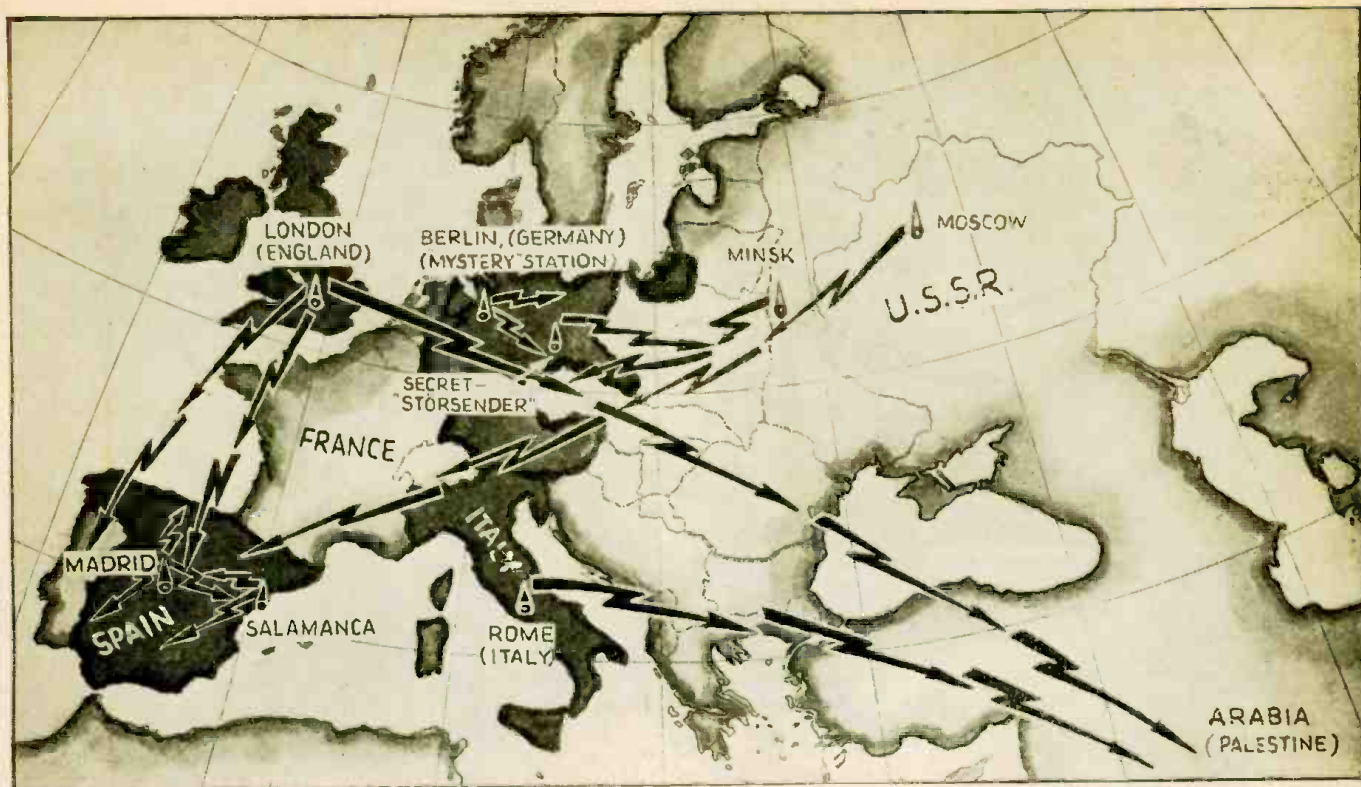

## EUROPE'S UNDECLARED RADIO WAR!

An Englishman tells of the relentless radio propaganda war being fought on the Western Hemisphere.

MICHAEL NORTON

THE use of "wireless" (radio) as a national weapon began during the Great War. In 1916, when the Germans could no longer use their submarine cables, they communicated with their military attaché in Washington by radio messages in code, sent by indirect routes. Unfortunately for them, this code soon fell into the hands of the British.

Toward the end of the War, there was so much use of codes that, when the news of the Armistice was announced from the Eiffel Tower, not in code, several operators refused to believe what they heard, thinking the enemy was playing a trick!

Over here in England, radio sets were forbidden during the War, and it was rumored that listeners had secret antennas fixed in disused chimneys. This may have been true; but I know that a similar thing occurred in Germany just after the War. In the occupied area, the Allies forbade the use of broadcasting and its reception within the area. Some German friends living in Cologne told me that they had an indoor antenna and so did many of their friends. The antenna was taken down when the set was not in use.

The first radio propaganda on a big scale was put out by Moscow. The Russians now broadcast propaganda in about 15 different languages, and they have the most powerful transmitter in

Europe. It has the same power as WLW, Cincinnati. Soon, however, the British Broadcasting Corporation is to build 2 powerful shortwave transmitters which will be the most powerful in the world.

The Russians are fortunate in that their time is 2 hours ahead of Central European Time, so that after their own programs, they can use nearly all their stations for broadcasting to the rest of Europe.

The Germans have made great efforts to jam the Russian transmissions. Some German friends of mine had a town house which they were compelled to lease to the secret police. The owners discovered by accident that the police had installed a *Störseuder*, or "interrupting station." It was intended for the interruption of the transmissions of the Russian station of Minsk, a town less than 50 miles from Russia's western frontier.

The moment that the propaganda in German starts from the Moscow station, interference begins. On the long waves it takes the form of Morse (code) or a kind of dynamo hum. On the shortwave transmission, the German interference is usually made by the continual playing of a phonograph record. The record is usually one of the waltz *Ramona*, but the Germans do use one other record, and this is of a slow fox-trot.

I know several Germans who listen to the Russian transmissions. This

means that the jamming is not always successful. This is especially noticeable on the short waves, where the skip distance effect may mean that you can hear the transmission but not the interruption. On the medium waves, things are different. Only a few weeks ago, a German told me that he tried to hear the speeches of Herr von Schuschnigg, the former Austrian Chancellor, but that he was unable to because they were jammed by the German authorities.

The most exciting event on the short waves took place last spring when a mystery German station suddenly appeared on a wavelength of 29.8 meters. Some say that it must be outside Germany, but nothing has ever been proved about this station. From 10 till 11 every night, it gives anti-Nazi propaganda, talking, for example, of the "gruesome barbarities of the Hitler regime." A German told me that the first night after this station was first heard in Berlin, half the population of the town knew about it. The station was said by the announcer to be in Berlin, but it could not be traced.

It was thought that the transmitter was placed inside a car, and the vehicle driven round the town; but when I listened here in England, the signal strength seemed too constant for that to be the case. After a time, the German authorities caused such severe jamming

(Continued on page 39)

# RADIO CREATES

Mr. Halbran, applying to fashion an amazing and endless variety of patterns created by television facilities, has instituted an entirely new tool for the stylist! Mr. Eichberg's engaging description, of how these patterns—due to a pencil of light moving at lightning speed—may find application in many new fields, will interest *Radio-Craft* readers.

As told to  
**ROBERT EICHBERG**  
By ANDREW W. HALBRAN

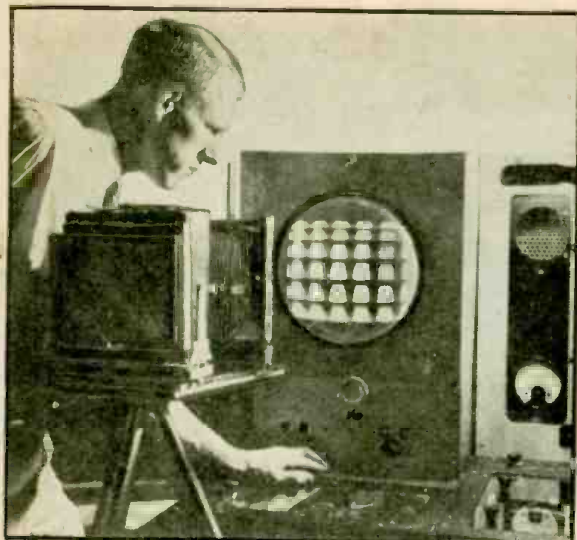
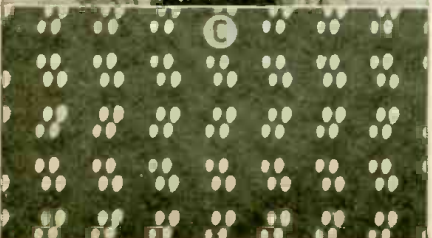
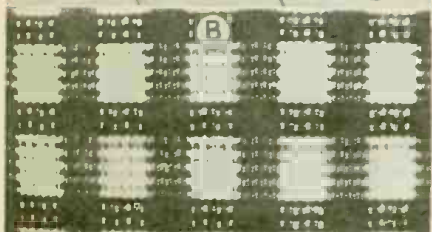
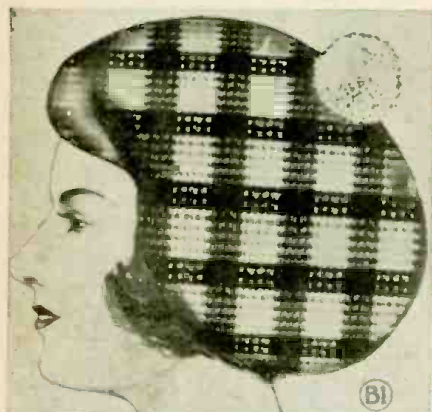

Fig. A. Mr. C. E. Burnett is here shown setting up and photographing the complicated electronic designs discussed in the text.



**T**EXTILE designers and others who must produce patterns in infinite variety breathed a sigh of relief when engineer C. E. Burnett of RCA's Television Research Laboratory produced a "radio kaleidoscope" (as the writer dubs it), the heart of which is the good old cathode-ray—or "C.-R."—tube, as used in television and oscilloscope work. (See "New 'Resolution Tester' for Cathode-Ray Tubes," Oct. '37 *Radio-Craft*.—Editor)

As you no doubt know, the patterns appearing on the screen of a "C.-R." tube may be governed by the voltages of various frequencies applied to the horizontal and vertical scanning electrodes. Innumerable patterns can be made to follow each other across this screen, and any that appear to have interesting (i.e., commercial) possibilities can be halted in its mad dash and anchored fast simply by proper manip-



ulation of the controls! Once it has been observed, it may be altered slightly—or greatly, for that matter—by adjusting the biases (voltages) and frequencies.

Nice though a pattern on a C.-R. screen may look, it is of little value, save to

study, unless it can be recorded in permanent form. This is easily done by means of a camera. A photograph of the image is snapped, and that's all there is to it. The tube's controls can be readjusted and a new pattern produced, while the films are developed and the prints sent wherever they are likely to do the most good.

Mr. Burnett is seen with the complete set-up in Fig. A. On the screen there is a pattern which looks much like a series of small cream bottles; it might be suited to sports dresses for country wear or a milkman's uniform, or to paper used to wrap butter, etc.

A slight turn of the controls, and the bottle-effect vanishes. The spaces between the horizontal rows of bottles grow larger and the bottles themselves are broken up, while a dotted effect, much like that which would result by weaving a heavy white yarn through a dark background appears to link the larger white blocks. It's practically a Scotch plaid (See Fig. B.), save that

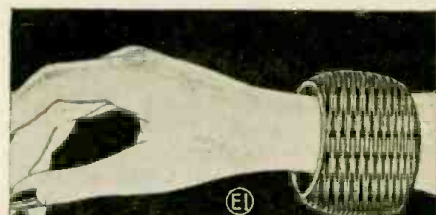
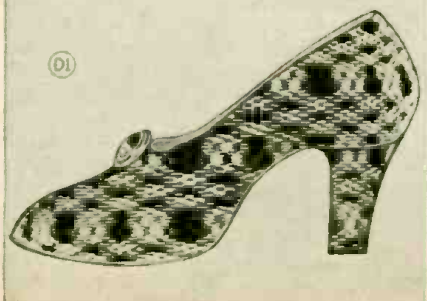
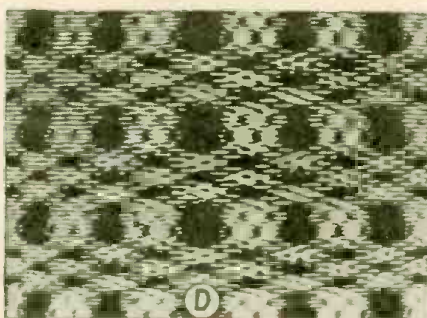

# AMAZING FASHION PATTERNS

the print is black and white, instead of being in every color of the rainbow, with a few extra added for good measure. As the illustration (Fig. B1) shows, it is an ideal pattern for a gay Tam O' Shanter. And it is also highly suited for use in blankets, golf socks, sport coats, skirts and sweaters—even for the background of the label on a bottle of Scotch!

Did you notice the dots between the blocks? Re-tuning the radio kaleidoscope brings them out as the dominant motif. (See Fig. C.) They make an excellent all-over small-figure pattern, suitable for silk dresses, scarves, neckties, and so forth. (See Fig. C1.) It is even said that they inspired a wallpaper manufacturer and a producer of china-ware.

## RADIO KALEIDOSCOPE CREATES "ELECTRONIC SNAKESKIN" PATTERN!

The "electronic snakeskin," used as a pattern for the shoe, may also be traced to a slight re-tuning from the plaid. Its effect is a deformation of the regularity of the blocks, with complete separation between the vertical rows while broken bands run between the horizontal rows. The pattern (Fig. D) may be printed upon or woven into the fabric of which the shoe (Fig. D1) is made, and a manufacturer has already signified his intention of bringing out such a model!

This finding of patterns through electronic means is by no means an entirely hit-or-miss affair. Research has proven that given frequencies may be relied upon to produce patterns of a certain sort. If, for example, a chain effect of linked lines is wanted, the electronic designer looks at his frequency chart, sets the controls and—presto!—a pattern similar to that used on the bracelet illustrated appears. The basic pattern is seen in two different forms in the accompanying illustrations, Figs. E and F. The former, you will notice, is precisely the design employed in the bracelet (Fig. E1); the latter, which is but little different, opened up an entirely new line of thought. It proved

to be the inspiration for a new pattern of decorative stitching, used to edge handbags and wearing apparel. But that was not all! The building and metal industries are expressing their interest in it, for they say it reveals the possibilities of a new type of joint.

Linked lines are also the basis of the basket-weave pattern which the cathode-ray kaleidoscope produces. A designer of women's accessories said, "It will make handbags which are simply fetching, my dear," and promptly drew a sketch (See Fig. G1.) to prove her words. Designers of draperies also plan to make use of this pattern in black background interwoven with heavy gold thread.

A little shift in the tuning controls breaks up the design into separate dashes which combine to form waves. Notice how the pattern in Fig. H is broken at the edge of the C.-R. tube's screen. A defect? Not at all! The break is utilized as a border for the lampshade shown in Fig. H1. It gives the logical finish to the design as a whole.

The lines were quite regular in that cathode-ray pattern. Adjusting the frequency robs them of their regularity and provides a new pattern—the zigzag effect of Fig. I. A designer of fans fell in love with it, with the result seen in Fig. I1. As the pattern effect is that of a flash, and as it was produced by the use of electronic apparatus, it might be termed the fashion industry's first real *Radio Fan*.

But the comparatively simple patterns described are not all that this apparatus can produce. It can make  
(Continued on page 38)

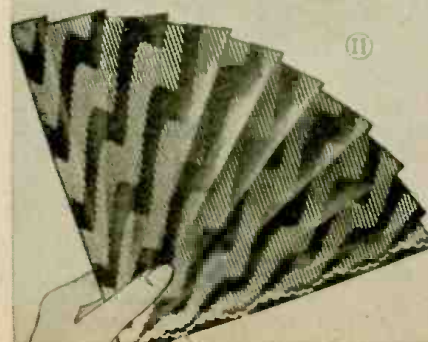
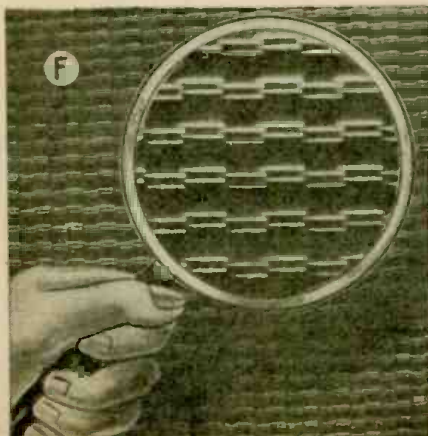
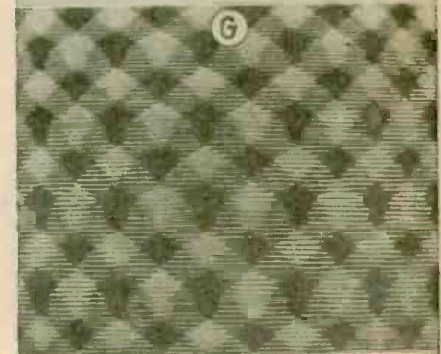

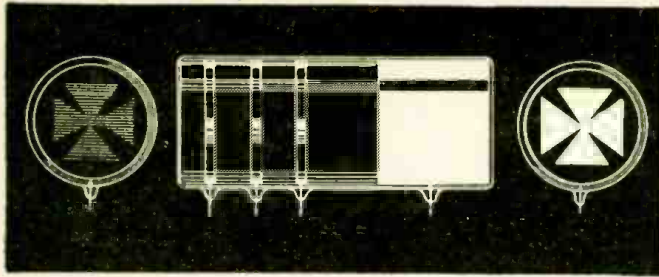

Fig. 3. The electron image (light amplifier) tube of the future.

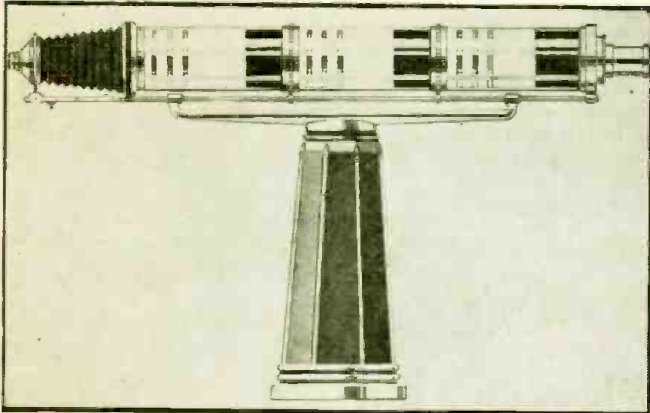

Fig. 8. The television receiver-projector of the future.

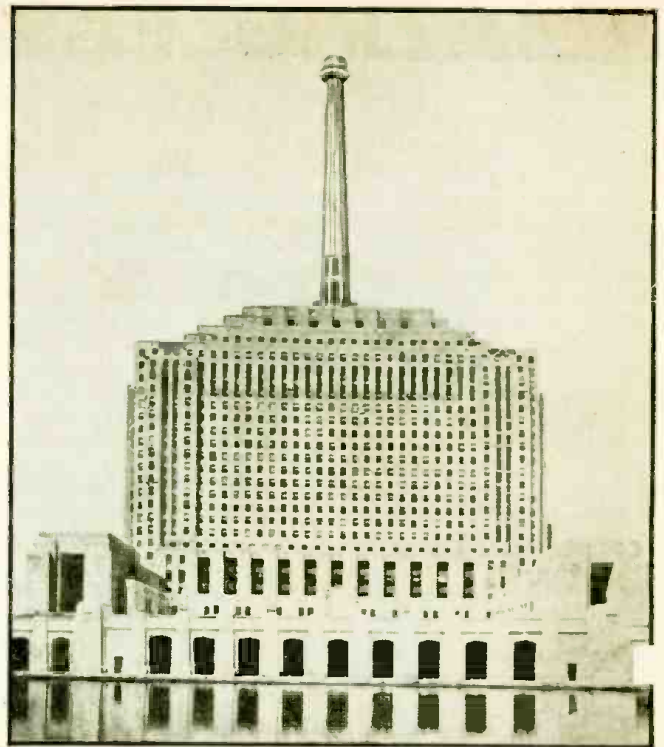

Fig. A. Artist's conception of the centrally-located television transmitting tower.

## TELEVISION WITHOUT SCANNING?

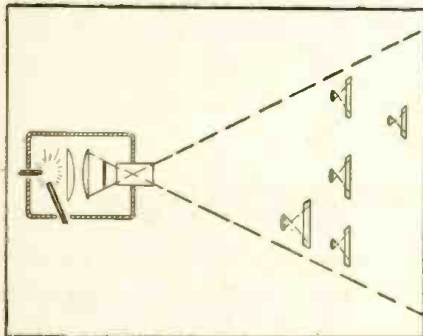

Fig. 1. Fundamental optics of the predicted television system. Extreme simplicity prevails.

Will telescopes and periscopes replace our present complicated television scanning apparatus? A well-known television pioneer leaves the beaten path and reasons-out a new television concept. Compare Mr. Sanabria's observations with those of another forward-thinking technician, Mr. W. E. Shrage, whose article, "Ultra-Ultra-Microwave 'Radio' of the Future," in the January 1937 issue of *Radio-Craft*, too, discards many hide-bound ideas.

U. A. SANABRIA

EVERY television worker has gazed, in his dreams, upon the El Dorado of a television system without scanning. The development of spot-by-spot scanning systems with all of their associated difficulties often cause the tired engineer to think about a system which has none of these objectionable scanning features.

### AN ANALYSIS OF PROBABILITIES

When we talk to a television engineer about the possibility of eliminating scanning, he will usually pass off your question with a smile of aloofness and imply that this possibility belongs to fiction writers. One can point out numerous examples in industrial history which reveal that ideal systems in theory are seldom resolved into practical devices. The gasoline turbine which eliminates reciprocating parts for automobile engines has never been perfected; the continuous running film camera and projector without intermittent movements for motion picture

science has never displaced the regular jerking mechanism (or has it?—*Editor*); the flapping wing airplane which takes off and lands like a bird has never been a competitor of the propeller and rigid wing system.

Such illustrations are the thoughts of the pessimist who represents the modern version of the man who thought that the automobile would never displace the horse, or the commonplace observation that "You can't stop a roaring train with wind" prior to the development of the air brake. In contrast with the above examples we find many seemingly ideal devices: the *water turbine*, the *steam turbine*, the *induction motor*, the *circular saw*, and hundreds of other examples of how fuss and commotion have been eliminated by the hard work of engineers who believed fundamentally in the slogan, "We can always improve."

The late Clarence Darrow explained that he stopped to analyze carefully the accuracy of his thoughts when he found

himself agreeing with the majority in any controversial matter. He was convinced that "The majority is always wrong." He reasoned that basically, higher intelligence is a characteristic of

(Continued on page 57)

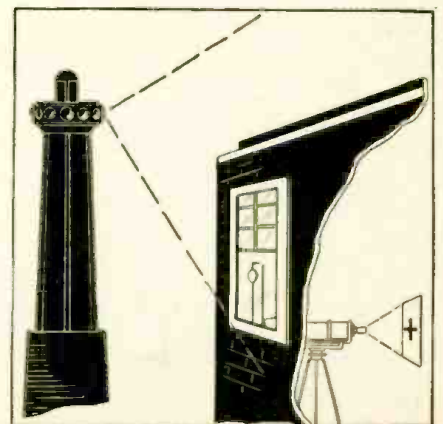

Fig. 2. A periscope in the home window picks up the transmitted television signal!

# NEW RADIO SERVICE "CAR"

120 miles to 1 gallon of gas! That is economy which Service Men will readily appreciate. This Motor Scooter and side-trunk is a practical "buggy", especially for suburban use.

G. E. DeNIKE.....

**S**INCE the day the Chesterfield cigarette girl suddenly burst forth on posters throughout the nation, posed on a new kind of a contraption



Fig. B. Adaptable to mobile P.A. systems.

which looked like a motorized scooter, popularity of this mode of conveyance has risen by leaps and bounds.

Throughout the country, spread the fad of getting about on these zippy little motor horses. It didn't take long for local merchants to realize that here was the ideal low-cost transportation for light deliveries if some sort of a carrying device could be attached to the conveyance.

The manufacturers of these Motor Scooters quickly grasped the significance of this situation and set their engineers to work, developing the kind of models needed for commercial application. They soon produced several models—of which the best one for radio Service Men is illustrated.

The handsome trunk built into the side-car position offers plenty capacity for the transportation of—test equipment, tubes, manuals, parts, tools, complete small radio sets and large radio chassis and speakers.

Here indeed is the answer for the Service Man to his problem of cutting



Fig. A. Reproduction of the cover painting.

down the transportation expense involved in service calls.

## LOW-COST TRANSPORTATION FOR SERVICE MEN

The maintenance of one of these Motor Scooters is scarcely more than that of a bicycle. The Service Man can ride from 100 to 120 miles on a gallon of gasoline, license costs are at a minimum and it takes very little "elbow grease" to keep the unit sparkling like new—which helps a lot to attract and hold the attention of prospective customers.

(Continued on page 54)

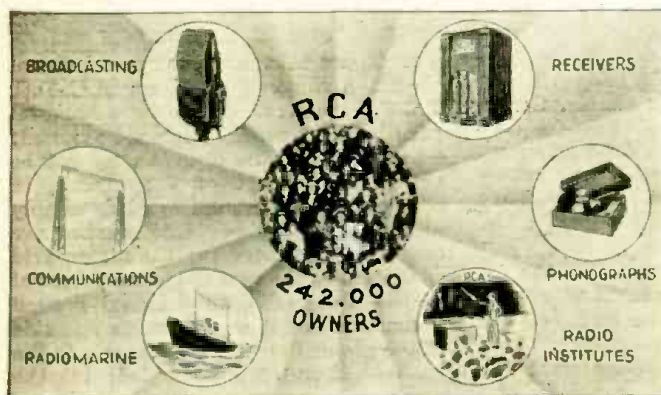

Some of the branches of America's Radio Colossus.

**W**HAT transpires behind the scenes of radio's largest corporation? How does it thrive? What is the nature of its transactions? How does this large organization fit into the commercial structure of our industry and country? These are some of the questions which the layman would like to have answered.

There are few companies in the United States whose ownership is more widely distributed than that of the Radio Corporation of America. Its stockholders are situated in every State of the Union. Since its business is essentially one of widespread public service it is only fitting that its ownership should be so widely shared.

Altogether there are approximately 242,000 owners of RCA stock. Forty-three per cent of this total number (more than 100,000), strangely enough, are women. More than half of the total number of stockholders (approximately 135,000) own 10 shares or less. Fifteen per cent of these stockholders (some 35,000) own 1 share each and only 10 per cent own as much as 100 shares each. No single individual owns as much as 1/2 of 1 per cent of the total stock.

# AMERICA'S RADIO COLOSSUS

Here are some interesting and revealing facts, which seldom come to the attention of the general public, concerning Radio's largest and most far-flung organization.

This indeed is one of the most widely spread and owned corporations.

In its structure this organization has some of the finest brains in the country, some recent additions being former vice-President of the United States, General Charles G. Dawes; and the eminent Engineer and President of the J. G. White Engineering Corporation, Mr. Gano Dunn. To give an idea of its many ramifications we will refer briefly to the principal events which have taken place since the first of this year as outlined at the 19th Annual Meeting of the stockholders of RCA.

## FINANCIAL TRANSACTIONS

In accordance with its recently-established policy of concentrating its investments within the United States the company, during the months of January and February, sold its Japanese and Canadian stockholdings. Its holdings in the Japanese Company (Victor Talking Machine Company of Japan, Ltd.) were sold for \$2,000,000. This transaction, however, included an extension of licenses, resulting in continuing royalties paid to RCA. Against this amount the company thus far received \$1,750,000 in cash, the balance of \$250,000 falling due January, 1939.

(Continued on page 59)

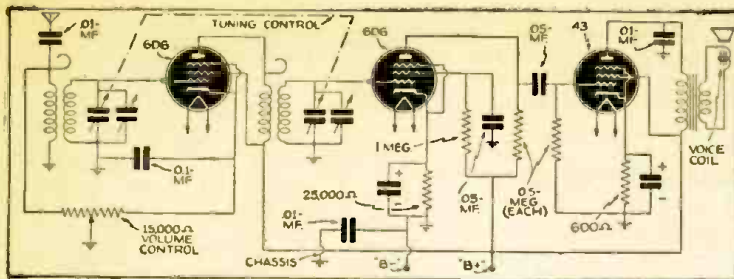

Fig. 1. Typical circuit of a midget A.C.-D.C. receiver.

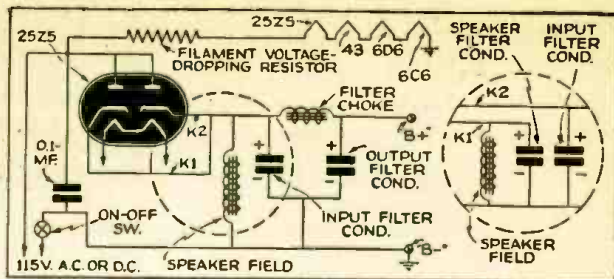

Fig. 2. Typical power-supply circuits of A.C.-D.C. sets.

## SERVICING UNIVERSAL A.C.-D.C. RECEIVERS

By special permission of National Radio Institute *Radio-Craft* is pleased to present an outstanding article, of exceptional importance to the average radio Service Man, which appeared in a recent issue of N.R.I.'s house organ *National Radio News*. This article is of unusual value to the practical man not only because it describes time-saving procedure but also because it explains in detail just *why* this procedure is preferable. Service Men will do well to actually *study* this article.

J. B. STRAUGHN

ONE of the most common types of receivers brought in for servicing is the "cigar box" type universal A.C.-D.C. receiver using a T.R.F. circuit with 4 or 5 tubes. Sets like these have been widely distributed over the entire country and have been sold at extremely low prices. Since manufacturing costs must obviously be kept down when a receiver complete with tubes is to sell for less than \$10, low-grade parts are often employed. Break-downs are frequent, and Service Men are expected to make prompt repairs.

Unfortunately for the customer, it costs very nearly as much to repair one of these small receivers as a larger set. When a customer hears the estimate of service costs, he generally exclaims: "Why, I can buy a new radio for less than that!"

This is true, sad to say, but the business-like Service Man will point out that the parts in the new receiver will be no better than those in the old one, and the same trouble will undoubtedly develop in a short time. On the other hand, if the old receiver is repaired, using first-class parts which the manufacturer could not afford to employ, excellent results may be expected. The cost of service work on one of these sets should really be considered a part of the purchase price, for the value of the receiver will be increased in exact proportion to the value of the new high-

grade parts. Such a line of reasoning seldom fails to bring in the job at a high enough price to give the Service Man a fair profit.

Although this article deals primarily with the servicing of "universal"-type (or A.C.-D.C.) T.R.F. receivers for which circuit diagrams are not obtainable anywhere, the procedures described apply equally well to these T.R.F. receivers when circuit diagrams are at hand, and will also prove of value in servicing universal A.C.-D.C. super-heterodyne receivers.

The signal circuits of a midget T.R.F. radio set are extremely simple. Generally there is one stage of radio-frequency amplification using a 6.3-volt super-control pentode tube such as the 78, 6D6 or 6K7. The former two types have the same base and are interchangeable, while the latter uses an octal base.

The R.F. amplifier feeds into the detector, which uses a pentode tube having a sharp plate-current cut-off characteristic. Interchangeable, type 6C6 or 77 tubes, or the octal-base 6J7 tube will generally be found in the detector stage.

The audio output of the detector is fed by means of resistance-capacity coupling into the power output tube, which is generally a type 43 pentode. This tube in turn feeds the loudspeaker; although a dynamic loudspeaker is more often used, you will occasionally en-

counter a magnetic speaker.

In some sets one or more *dummy* tubes will be found, with only the filaments connected into the circuit. As long as the filament circuit is not open, the condition of a dummy tube is immaterial; in fact, defective tubes are often used originally by the manufacturer to keep costs down while making the customer think he is getting a larger receiver.

### TYPICAL "UNIVERSAL" CIRCUIT

In Fig. 1 is shown the typical signal circuit arrangement of an A.C.-D.C. T.R.F. receiver. There are several peculiarities which should be noted; these are: (1) the chassis may not be an electrical part of the circuit, in which case the ground symbols simply indicate that the parts so marked are connected together; (2) the screen-grid of the R.F. tube gets the same potential as the plate; (3) an external ground connection is not used because one side of the power line (which connects to the receiver circuits) is grounded; (4) the small coils connected to the primary R.F. coil windings provide capacitive coupling in addition to the usual inductive, primary/secondary coupling.

The aerial for a midget set is usually of flexible wire, permanently attached to the set and connected to the receiver input circuit through a small tubular or mica condenser. This aerial wire may be grounded to a water pipe or other external ground, in which case the R.F. signals picked up by the ungrounded side of the power line will flow through the primary of the 1st R.F. transformer, then through the antenna condenser and the aerial wire to ground. The R.F. signals passing through the primary induce a signal voltage in the secondary in the usual way.

If the chassis is an electrical part of the circuit and the line cord plug is inserted in such a way that the chassis connects to the hot (ungrounded) side

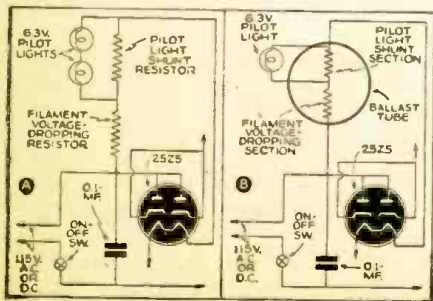

Fig. 3. A and B are different pilot light hookups.

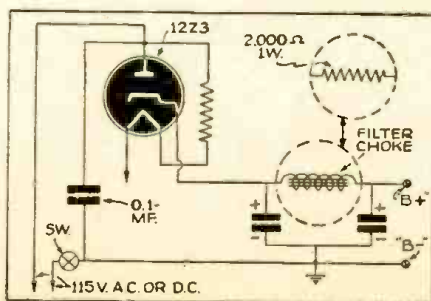

Fig. 4. The rectifier and filter circuit.



of the power line, you may get a shock when you touch the chassis if some part of your body is grounded. If you get a shock, reverse the line plug if the source is A.C.; this will connect the chassis to the grounded side of the power line. In the case of D.C. power you cannot reverse the plug, for that would make polarity incorrect; you will simply have to avoid standing on a concrete floor (a good ground), and avoid touching any grounded object while working on the set with power on. With either A.C. or D.C. power, never make a direct connection from the chassis to an external ground, for this may short-circuit the power line and blow the line fuse.

#### TYPICAL A.C.-D.C. POWER SUPPLY

Figure 2 shows a typical power supply circuit used for both T.R.F. and superheterodyne universal A.C.-D.C. sets. A 25Z5 tube is connected as a single half-wave rectifier, but where the loudspeaker field coil is energized independently of the receiver circuit, there will be a separate connection to each cathode and an extra filter condenser connected directly across the loudspeaker field, as indicated in the dotted circle at the right in Fig. 2.

The tube filaments in a universal receiver are wired in series, with each filament requiring 0.3-ampere. The filaments of the type 25Z5 and 43 tubes require 25 volts each, while the 6D6 and 6C6 tubes each require 6.3 volts. This makes a total of approximately 63 volts, and means that the filament voltage-dropping resistor must drop 115 - 63, or approximately 52 volts. Since 0.3-ampere flows through this resistor, it will have an ohm value of  $52 \div 0.3$ , or approximately 175 ohms.

If pilot lamps are used, they are usually placed in series with the voltage-limiting resistor. Each lamp is operated at about 4.25 volts, and hence the required voltage drop across the limiting resistor is reduced by this amount. Two pilot lamps connected as in Fig. 3A reduce this required voltage drop by 8.5 volts. (Although the lamps are rated at 6.3 volts, they are operated at 4.25 volts to prevent burn-out on surges.)

Pilot lamps are always shunted by resistors, for these lamps do not draw as much current as the tube filaments. The shunt resistance will be equal to the shunt current (the difference between the 0.3-ampere filament current and the pilot lamp current) divided into the voltage across the lamp or lamps.

**Pilot Lamp Color Code.** On A.C.-D.C. sets, only 2 types of pilot lamps are ordinarily used; these can be identified by the color of the glass head through

which the filament-supporting wires pass. A mazda No. 40 lamp with a miniature screw base draws 0.15-ampere and has a brown-colored bead. A mazda No. 46 lamp with a miniature screw base draws 0.25-ampere and has a blue bead, while a mazda No. 44 lamp with a bayonet base also draws 0.25-ampere and has a blue bead. A third type of lamp, having a white bead and drawing 0.20-ampere, is infrequently encountered. Replace burned-out lamps with new lamps having the same bead color and voltage rating (6.3 volts).

You will occasionally find 2 pilot lamps connected in series directly across the 110-volt line, with no shunt resistor across them. These will be 110-volt Japanese lamps similar to those used on Christmas trees. They are connected in series to operate at half-voltage, thereby having longer life while still giving sufficient light to illuminate the tuning dial.

**Types of Filament Resistors.** Various types of filament voltage-dropping resistors are used in universal A.C.-D.C. sets. Many of the earlier models use ordinary wire-wound resistors mounted under the receiver chassis. The chief disadvantage of these is that the heat which they radiate causes deterioration of nearby receiver components, chiefly the electrolytic condensers.

Line cord resistors, having the resistance wire embedded in asbestos and placed in the line cord along with the usual 2 copper wires, are now widely used because they keep the dissipated heat entirely out of the chassis. Line cords are easily identified by the fact that they have 3 leads instead of 2; the resistance wire is connected to one of the line wires, the connection being made directly to one of the prongs on the line cord plug. The line wire which connects to this same prong may be identified with an ohmmeter, and always goes to the rectifier plates. The other line wire will go to the ON-OFF switch which is mounted on the volume control of the receiver.

When a receiver which uses a line cord resistor is in operation, the line cord becomes quite hot, but this is natural and is no cause for worry. Never attempt to shorten the line cord when it has a built-in resistance, for this would reduce the resistance value and affect the operation of the receiver.

Ballast tubes are even more satisfactory than line cord resistors for filament voltage-dropping purposes. These tubes can now be secured with either glass or metal envelopes, the metal envelope being the more popular. The resistance element is mounted inside the

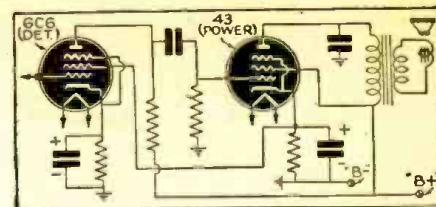

Fig. 6. The detector screen-grid obtains its bias from the cathode of the power tube.

envelope and connected to prongs on the tube base. Oftentimes taps are provided, with connections to tube prongs, to eliminate need for separate pilot lamp shunt resistors; an example of a ballast tube having one tap for this purpose is shown in Fig. 3B.

When a ballast tube burns out, always replace it with another having exactly the same number. This is necessary because the tubes are made with many different ohmic values and with many different arrangements of prong connections. Ballast tubes become very hot while in use, but as the heat is above the chassis, critical parts in the receiver are not damaged.

Service Men are sometimes asked to replace line cord resistors with ballast tubes; space limitations make it inadvisable to attempt this, for midget receivers are quite compactly constructed. Incidentally, an ohmmeter provides the quickest way of identifying the various prongs on a ballast tube.

**Rectifier Circuit Variations.** A single 12Z3 rectifier tube or even a type 37 triode with grid and plate connected together may be found in a circuit arrangement like that in Fig. 4. Since supplying field excitation to a dynamic speaker would place too heavy a drain on the rectifier, you may expect to find a magnetic loudspeaker in a receiver having this power pack circuit. The 0.1-mf. condenser connected across the power line tends to prevent interference from entering the receiver by way of the power line. Oftentimes a 2,000-ohm, 1-watt resistor is used in place of the more efficient but bulkier and more costly filter choke, as indicated inside the dotted circle in Fig. 4.

Sometimes you will find a circuit which uses two 12Z3 tubes connected in place of a single 25Z5; the circuit will be the same as that in Fig. 2 except that the 2 diode sections of the rectifier tube will be in separate envelopes. The filaments of the two 12Z3 tubes will be in series and will together be electrically equivalent to the filament of a single 25Z5 tube. This gives the set an extra tube and is therefore an advantage from a sales standpoint. The

(Continued on page 46)

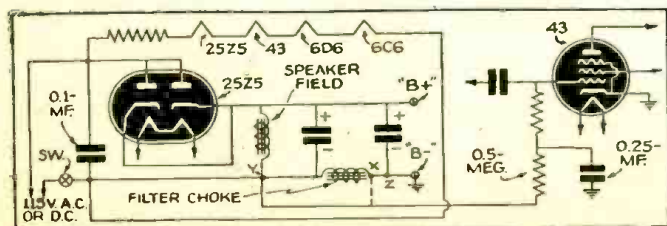

Fig. 5. Another power-supply circuit with the filter choke in the negative plate-supply lead.

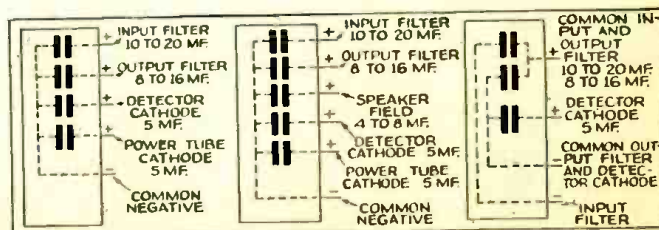

Fig. 7. Typical connections for the electrolytic condenser blocks used in midget A.C.-D.C. sets.

# SERVICE MEN!— REPAIR YOUR CUSTOMERS' SETS "BETTER THAN NEW"!

A Service Man of over 12 years' experience, and who for the past few years has personally supervised an average of about 1,500 jobs per year, gives you the benefit of his practical experience. Most important of all he shows you in simple, straightforward fashion wherein lie the moneymaking possibilities of radio service.

GEORGE W. HALDER

**M**OST radio Service Men look upon themselves as technicians of unquestionable merit who, as a whole are very much underpaid, very much abused and very much underrated. They believe that they belong to an upper strata of humanity affiliated with the geniuses of the mechanical industry. Why? Because, with the aid of several hundred dollars' worth of scientific instruments, they can cause a silent radio set to once more give forth raucous sounds, which they proudly explain to the customer, is the same reception he once had when the radio set was new.

They believe that by merely replacing a punctured condenser, or an open resistor, they have accomplished a miracle and "repaired" a radio receiver. Probably the variable condenser plates are dirty, the bearings dry and squeaking, the volume control noisy, the speaker rattles now and then, the resistors have changed value up to 50% of their original tolerance, but what of that, their job is done—the "radio" is once more running.

So it is sent back to the customer, and the customer wonders why he had to pay so much money to have a 25c part replaced. The customer was probably told he would have his set returned as good as new, and he finds that it is not much better than before it stopped, so, and not without some justification, he calls the radio service business a "racket," and the next time he has trouble he calls the janitor, or some high-school boy, and probably gets an equally good job for one-fifth of the cost.

## THE "SCREWDRIVER MECHANIC"

Service Men wonder why business is not as good as it could be; probably an analysis of their shop methods will explain a lot! Thousands of dollars' worth of business is lost every year to the part time worker, and the screwdriver mechanic, who operates from his cellar, or attic, repairing his friends' "radios," and just as long as he can turn out as good work as a professional shop, just that long will he continue to do a thriving business. Every dollar's worth of work done by this type of mechanic represents a loss of \$3 to \$5 to a legitimate shop. The only way to stop this loss is to turn out work of such excellent quality that he can no longer hope to com-

## SAYS THE AUTHOR:—

"The extra preliminary work (herein described) takes time, so does the proper adjustment of the selectivity curves;—but it makes for satisfied customers, you get fewer call backs, and you are perfectly justified in charging more for your work.

"Don't be 'price conscious,' cleaning and alignment as described herein is worth \$5 of anybody's money and when you return the radio set to the customer you are proud of your work. Tell him what you have done, explain it to him while you install the chassis in the cabinet, tell him about the oscilloscope. He may not admit to you that the set is any better, but how he will brag about it to his friends!—and that is what makes good business;—a satisfied customer giving you free advertising every time anyone mentions 'radio!'"

pete with you—and educate the public to the fact that your work is worth the difference.

No workman in any line of industry is really expert until he is conscientiously thorough on every job, until he has an open mind ready to receive new thoughts, and methods which might be an improvement on his methods, and until upon completion of a job he can honestly say, "This job, barring the customer's restrictions, is perfect, and as good as new."

It is not sufficient to just repair a set, it *must* go back to the customer's home performing *as good*, or *BETTER* than it did when he first bought it. This means a satisfied customer, and a satisfied customer will talk, and *word of mouth advertising is the most powerful type of advertising in the world.*

Of course there are plenty of shops with full equipment and competent technicians in charge, who turn out perfect repair jobs, but on the other hand there are countless hundreds of shops which turn out very poor work, either through lack of ability, or probably the greater evil, insufficient knowledge of proper servicing methods.

The author has been actively employed in radio service work for over 12 years, for the past few years has personally supervised about 1,500 jobs a year, and naturally enough has developed a certain technique for the handling of these jobs. In the following chapters he will endeavor to take the reader through the servicing of a superheterodyne chassis, using his methods.

## MODERN EQUIPMENT ESSENTIAL

The radio service shop must, of course, have a complete assortment of testing equipment. The days of a radio shop built around a single analyzer, and tube tester, are definitely over. Essential equipment is recognized as a good A.C.-D.C. voltmeter, calibrated oscillator, modulator and cathode-ray oscilloscope, tube tester equipped with sound, and some sort of audio oscillator. Probably the most important piece of equipment, and the one that is seldom found in a shop is an air compressor, with flexible tubing attached to an air nozzle, for blowing dust out of the radio chassis. Compressed air is the only way of reaching into the trimmer condensers, coils and switches, for the removal of dirt. Last, but not least, a bottle of Russian (or "mineral") oil, and a camel's-hair brush.

The first step is to remove all tubes, wipe them off with a damp cloth, and test these tubes thoroughly; if the tube tester is equipped with sound, rap the tubes severely with a small rubber hammer to locate weak joints and shorts.

With about 80 pounds of air pressure, blow the dust off the chassis, and from between the variable condenser plates; 20 or 30 pounds pressure can be applied to the trimmer condensers, and coils without fear of injuring these parts if a little care is used. This cleaning of the trimmer condensers is very important; dust collects between the multiple plates of these small condensers and due to speaker vibration will shift back and forth, sometimes expanding the adjustment and at other times sifting out, thereby increasing the capacity, and this makes plenty of difference in the overall performance of the radio, due to changing the acceptance curve of the intermediate frequency amplifiers, and of course causing the oscillator to drift off frequency, and changing the dial setting.

Probably the two things that impress a customer most is a clean chassis, and a tuning dial that is adjusted right on the dot. If a local station is on an assigned frequency of 1,400 kc.—that is where he has a right to find it, if a local low-frequency station is at 570 kc. that is where the pointer should rest when the station is properly tuned-in. Of course the author understands that the radio

set probably *never did* tune on-frequency, but that is your job, it means a more satisfied customer, who will be a booster for you.

Cleaning the loudspeaker calls for a different procedure. First loosen the cone centering screws, allowing the cone to float freely, then connect 110 V., A.C. across the field coil, this will relieve the pole piece of any residual magnetism and allow you to blow out not only dust but any metal filings that may have collected in the air gap. Air pressure for this purpose will vary from 30 to 80 pounds, depending on the type and size of the speaker cone. Do not be afraid of blowing the voice coil apart; if it does loosen under the strain of the air pressure, it needed repairing anyway and would have buzzed or rattled at certain frequencies. Loose voice coil wires can be cemented together again with speaker cement, but if there is an air space between the voice coil wires and the paper form upon which they are wound it is best to replace the entire cone. Re-assemble the speaker, using shims on both sides of the voice coil, i.e., inside and outside.

#### THAT BOTTLE OF "SERVICE OIL"

Now we come to that bottle of oil. Most of you are dubious or openly skeptical as to what value oil is in the servicing of a radio chassis. Sort of makes a person think of greasing an automobile, but try this method once and you will always use it. Remember, this oil is not a common oil, it is especially suited to our needs, it will pass no current, it will not detract from R.F. gain at high or low frequencies, it does not become gummy, and it does wonders in a noisy or "intermittent" radio receiver.

Did you ever have a noisy carbon volume control in the grid circuit of a 1st-audio tube? Did you ever remove the back cover plate of one of these controls, and notice the number of metal-to-metal contacts that carry the contacting arm on the resistance element to the center terminal on the case? Try a little mineral oil applied with a camel's-hair brush to these contact points; don't be too fussy—the oil will not harm the resistance element, but be sure it reaches 'way in to the center of the circular contacting member. Now try the volume control in the circuit. Quiet? Just like silk, probably better than a new one. One-tenth megohm, or higher value resistance elements seldom wear out, but the metal-to-metal contacts do get dirty and oxidized. One application of this "service" oil takes care of these points for years to come, by preventing further oxidization. Of course if the control has a defective resistance element nothing can effect a satisfactory repair other than replacement, but this only happens about once in 20 times.

Every movable part in the radio set—rheostats, potentiometers, wave-band switches, supporting bearings for switch mechanism—should be treated with a touch of oil at the bearing point only; do not be too liberal, a little oil applied at the right point is far better than having oil leaking all over

the chassis. The variable condensers get their share on both end bearings, and on the brass contacting strips, also put oil under the brass strips where they contact the divisional shielding plates. On old or badly oxidized condensers it may be advisable to scrape or sandpaper the divisional plate before applying the oil.

Next apply oil to the pins of every tube before inserting them in their sockets, this will clean the sockets; connect the speaker to the chassis, and plug the line cord in the A.C. outlet, turn the current on and measure the high voltage from the rectifier plates to ground, to determine if both sides of the power transformer are equal and of approximately proper voltage. Next insert the rectifier tube and let the radio set run while the balance of the tubes are replaced; this allows the radio receiver to be subjected to excessively high voltages from the power pack for a short time, and if a part is definitely weak, it is much better to have it break down in the shop than in the customer's home a week later. If tube shields are used, a little oil applied to the part that contacts the chassis ring will insure a good contact and perfect shielding.

Now we have come to the point where the average mechanic begins work, but we know that tubes, contact elements, etc., are in perfect condition, and that if a noise or some other disturbance is noticed after operation is restored to the chassis, that it is definitely a defective part, and valuable minutes will not be wasted in searching for a poor contact in a wave-band switch or something of similar nature. As far as the testing of a "dead" radio set is concerned, probably anyone's method is as good as the author's. Usually the procedure is to check for approximately 200 V. between ground and the plates of the A.F. output and R.F. plates, then for proper screen-grid voltages and so on. Any shorted condenser causing voltage loss is easily found, as is an open resistor. Replace any defective parts with suitable replacements, making the part mechanically secure before soldering. After operation is restored, turn off the current, and quickly check the bleeder, coupling and bias resistors for tolerance, replace any that deviate more than 20% from the original specifications.

#### ALIGNMENT

Now we have reached the point where we must align the tuned circuits. Never align a chassis while it is cold, always let the radio set under test run for at least 15 minutes before attempting any alignment adjustments, this same applies also to the oscillator and modulator. Set up the oscillator to a 10 kc. frequency-modulated signal on the I.F. of the receiver and align the I.F. stages according to the manufacturer's instructions, but *flat-top those curves*. Be definitely sure you give the customer at least a 10 kc. band-width in the I.F. stages. He bought the radio set primarily for tone quality, and real enjoyment of local broadcasts. Don't send

(Continued on page 58)

Equipment of Old-Fashion Radio Shop ~



Equipment of Modern Radio Shop ~

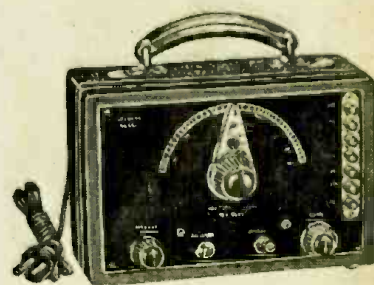
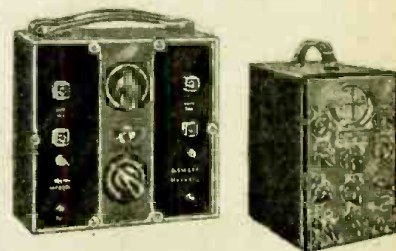

# SERVICING

Continuing the discussion from Part I, two typical electro-mechanical tuning systems are here described for the benefit of all Service Men. Pushbutton tuning is here to stay . . . get acquainted with it now, while it's yet new.

## PART II

CHARLES SICURANZA

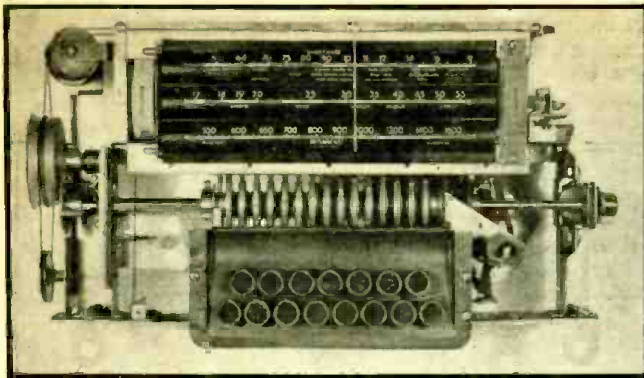

Fig. B. Front view of the Stewart-Warner electro-mechanical pushbutton tuning mechanism . . . a marvel of mechanical ingenuity.

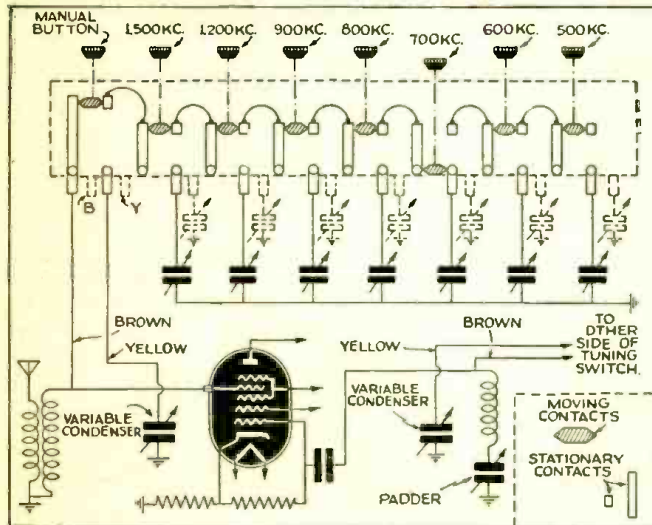

Fig. 14. The Meissner pushbutton assembly; circuit-transfer type.

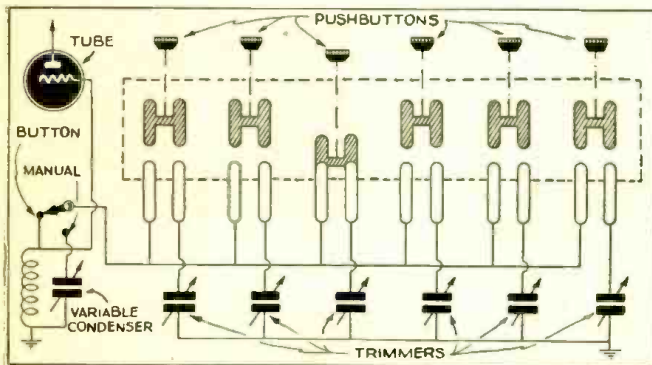

Fig. 15. A typical pushbutton assembly of the circuit-closing type.

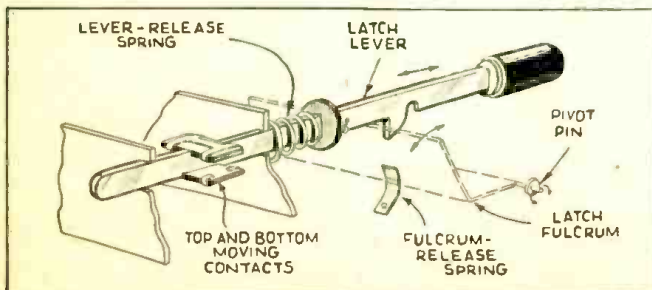

Fig. 16. Section sketch of a latch-type pushbutton switch. The latch keeps the button depressed until another button is pushed in.

**U**NDER the general classification of Mechanical Systems of Pushbutton Tuning, we encounter some of the simplest mechanisms in the smaller sets; while in the larger sets, we find some of the most intricate and high-precision assemblies ever seen in a radio receiver.

### MECHANICAL BUTTON TUNING WITH MOTOR DRIVE

The Stewart-Warner, 15-Station Magic Keyboard mechanism is an example of *mechanical button tuning* with motor drive. A front view of the Keyboard assembly is shown in Fig. B. The complete mechanism is unusual in several respects and its operation and setting up differ radically from the previous examples cited. Figure C shows the rear view of the mechanism.

As can be seen, 15 stations may be set-up, from the front of the receiver, without tools. Once the buttons have been set up, stations may be tuned-in almost instantly because the dial pointer travels directly to the desired station. In previous descriptions of motor tuning, it was seen that the dial pointer often had to travel the full length of the dial, reverse and return to the desired station. By utilizing an eccentric cam of special design for each button, the driving motor is made to turn clockwise or counter-clockwise, depending upon which station-button is pressed.

As with other modern systems, the station buttons do not have to be kept pushed-in by hand. The button is pushed in and all the other buttons are released automatically, so that even if two or more buttons have been pushed in at one time, all are released by pressing down any other free button. In this connection, it is interesting to note that if two buttons are pressed-in together, the dial pointer will move to the nearest of the two stations and stop.

With other systems, the dial pointer will keep on moving across the whole length of the dial, back and forth, until a third button is pressed, to release the two previously depressed buttons.

Another unusual feature is found in the Manual tuning changeover. In this system, there is no knob to turn when either hand or button tuning is desired. The slightest twist of the tuning selector knob disengages the cam assembly, releasing any depressed button and extinguishing the light signal reading "Automatic" while the Band Indicator and Visual Tuning Indicator light up. The A.F.C. voltage is always turned off for hand tuning and automatically turned on for button tuning.

Hand tuning is of the "spinner" type, effected by means of a weighted flywheel at the end of the tuning knob. This knob does not turn when the set is button-tuned—as it does in other motor systems.

### SETTING UP STATIONS

To set up stations on the keyboard, use the following step-by-step procedure:

- (1) Allow the set to warm up for 20 minutes so that all parts will reach a constant temperature.
- (2) Remove the large station tuning knob by pulling straight out, exposing a small set-up knob on the same shaft.

# PUSHBUTTON TUNING SYSTEMS

(3) Grasp this set-up knob and pull it out as far as it will go, rocking it slightly so that the gears will mesh properly.

(4) The set-up knob should next be tuned to the right (clockwise). The knob will turn rather stiffly and the dial pointer will travel over to the right side of the dial scale. After the dial pointer reaches the right extremity of the dial scale, continue to turn the set-up knob clockwise about  $\frac{1}{4}$  of a turn until a definite stop is reached.

(5) Push any button you wish to set up for a station. There need be no relationship between the position of the button on the keyboard and the station on the dial. Be sure the button is pushed all the way in. You will note that as the button is pushed in, the word "Automatic" will appear illuminated on the small indicator at the right side of the dial, and the keyboard mechanism will instantly move the dial pointer to some spot on the dial scale, according to the previous setting of the mechanism. This need have no relation, however, to the station for which you desire to set the button.

(6) Grasp the set-up knob again and tune the receiver to the desired station. Tune carefully and watch the dimming reactor tuning indicator for the point of least illumination so that the set will be accurately tuned to the station.

(7) The depressed button is now set to the station and should be labelled at once with the proper tab. The next step is to release the button set-up, and this is done by simply pushing in the next button you desire to set-up.

(8) Then tune in with the set-up knob the next station you wish to receive for the button that is now depressed, again making use of the Visual Tuning Indicator to be sure that you are correctly tuned to the station.

(9) Continue to set up as many other buttons as desired in the same manner; that is, push in the button, tune in the desired station, then push in the next button, and so on.

(10) In order to release the button which last remains depressed (the last one you desire to set up), grasp the set-up knob and push it back into the cabinet as far as it will go and then pull it out again. Do not forget to rock the set-up knob slightly when pulling it out, to properly mesh the gears.

(11) Turn the set-up knob to the left (counter-clockwise); the knob will turn rather stiffly and the dial pointer will travel over to the extreme left side of the dial scale. Continue to turn the set-up knob to the left even after the pointer reaches the end of the dial scale. Apply a firm pressure until the knob reaches a definite stop.

(12) Push the set-up knob back into the cabinet again and put on the large knob that was originally pulled off. The Magic Keyboard is now completely set up for operation.

## TROUBLE-SHOOTING THE "MAGIC KEYBOARD"

Some of the troubles which may occur in the Stewart-Warner models 1845 to 1869—which use the Magic Keyboard—are as follows:

**Button Does Not Stay In or Does Not Release:** Kickout pointer tip improperly adjusted. Kickout spring bent down too far. Insufficient tension in Key stop bar return spring. Star wheel stuck or not moving freely on tuning shaft. Kickout tip jams against star wheel. Stuck or jammed pawl or key.

**Pointer Does Not Move When Button Is Pushed:** Reversing contacts on back switch not closing. Motor stalled due to mechanical overload and clutch *not* slipping. Motor runs but pointer does not move, due to clutch slipping. Pointer drive gear slipping on shaft or out of mesh. Motor does not hum and tuner does not move with button in, due to power contacts on back switch not closing. Power contacts on side switch not closing. Bakelite back switch operating cam binding on contact arms or out of position.

**Pointer Moves But Does Not Tune Station Properly:** Due to improper setting-up of mechanism or not locked up tightly. When no signal is heard it may be due to Mute contacts not opening. Gang condenser drive-gears out of mesh or

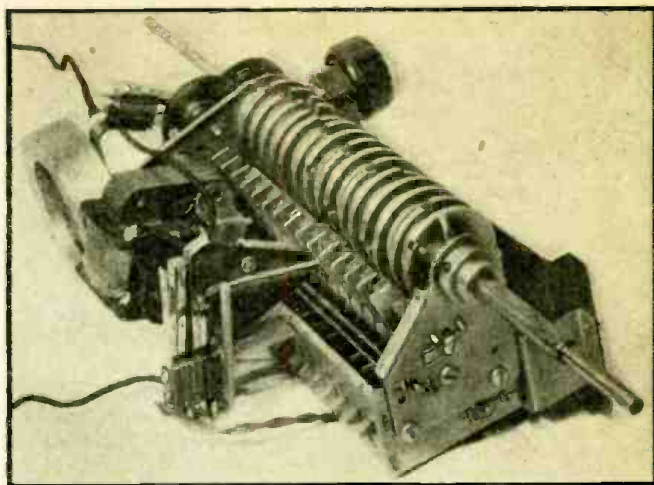

Fig. C. Rear view of the Stewart-Warner pushbutton tuning mechanism.

slipping on shaft. If signal is not heard clearly it may be A.F.C. contacts on back or side switch not opening or A.F.C. not functioning.

**Motor Continues to Run** when pawl does not fall far enough into station selector cam to cut off power to motor. Pointer stops at a *different place* each time for a certain button, due to pointer drive gears slipping out of mesh or on shaft. Mechanism not locked up tight or left-end bearing bracket loose.

## PHILCO AUTOMATIC DIAL

While it is true that pushbuttons are not used in the Philco dial, nevertheless there are modifications of this same mechanism using buttons, employed by other manufacturers.

As used in the Philco sets, the dial may be set up to tune in 15 or more stations. The method to use in setting up stations is as follows:

Remove the 2-piece tuning knob and the 3 flat-head screws which hold the circular metal plate to the tuning shaft hub. The dial control screws and station tab slits are now exposed. Tune the set to the lowest frequency station, and press in (with a screwdriver) the dial control screw which is nearest to the bottom of the dial. With the screw pressed in, rock the screw left and right until a click is heard. When the click is heard it denotes that the control screw finger has engaged in the tuning gate and the dial escutcheon will move the dial scale back and forth with the motion of the screwdriver. Tune the desired station as accurately as possible with the screwdriver pressed in and then release the screw.

(Continued on page 40)

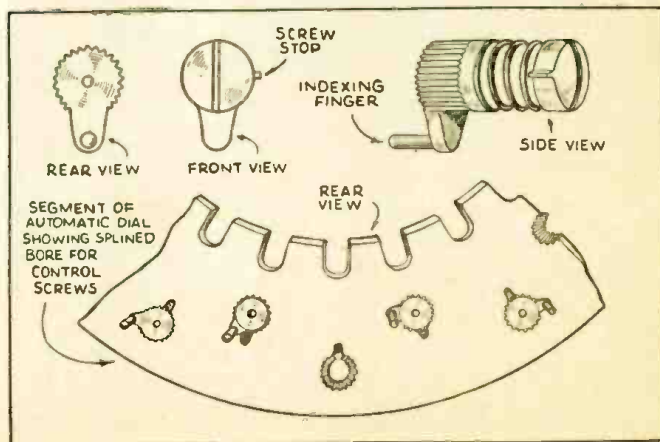

Fig. 13. Segment of the Philco automatic dial showing the splined bores for the control screws.

# NEW CIRCUITS IN MODERN RADIO RECEIVERS

The details of the modern radio receiver circuits that make them "different" from previous designs are illustrated and described each month by a well-known technician.

F. L. SPRAYBERRY No. 10

## (1) MOST EFFECTIVE AC-DC POWER SUPPLY

**Crosley Model 647.** Uses voltage-doubling for A.C., obtaining high voltage without a step-up transformer and switches field in line-shunt connection for D.C. providing maximum D.C. available.

In Fig. 1A will be seen the familiar 2-section 25Z5 rectifier with the plate of one section connected to the cathode of the other section. The remaining cathode thus becomes the high-voltage positive lead while the remaining plate is the high-voltage negative lead. The no-load output voltage is double the A.C. peak input voltage, and the exceptionally large filter condensers (50 mf. each) are required, as they must store the complete power between them every half-cycle. They are alternately charged in parallel and simultaneously discharged in series by the load.

For D.C. operation the field is shunted across the line in series with one section of the ballast resistor so that it will carry the correct current, leaving one rectifier section free so that no unnecessary voltage drop will occur in the high-voltage supply. The change from A.C. to D.C. operation is made by switching as indicated in the figure.

## (2) A.V.C. WITH POWER DETECTION ACHIEVED WITH NO DIODE OR ADDITIONAL APPARATUS

**Fairbanks-Morse Model 5A.** Although very much simplified, the circuit has the advantages of diode operation and A.V.C. using only a triode.

The 2nd-detector acting as in Fig. 1B as a power detector with a near-cut-off bias, half-wave rectifies the I.F. signal in the grid-cathode circuit resulting in the grid becoming negative in proportion to the signal strength. The top end of the grid return resistor thus becomes negative in proportion to the I.F. carrier strength in the circuit. A large condenser value (0.25-mf.) filters this to essentially pure D.C. and it is used for A.V.C. The positive I.F. pulses or alternations carry the signal to the plate where the I.F. variations are smoothed out by means of the 0.001-mf. condenser; the audio component then remains.

## (3) HIGH-GAIN DIRECT COUPLING ACQUIRED WITH CONVENTIONAL TUBES

**Emerson Models AR-171, -65, -66, -73, -74, -76, -77, -80 and -85.** The simplest possible direct coupling between the next to last and output stages is required in these sets with no auxiliary parts, ordinary plate voltage and conventional triode tubes.

A type 76 input tube of the amplifier in Fig. 1C is arranged to draw its cathode current from the grid of the output tube. Its plate is directly connected to "B+" so that as its grid varies at A.F. the plate current variations will bring about cathode voltage changes. The load for this tube is the grid-cathode circuit of the output tube. The output grid must remain positive at all times and the tube must be fitted for operation at minimum distortion when thus operated.

Grid variations of the 76 cause amplified cathode variations in it. Grid variations of the 6AC5G tube must identically follow these variations of the 76's cathode (the two elements being directly connected); subsequent amplified signals then appear at the output plate.

(Continued on page 55)

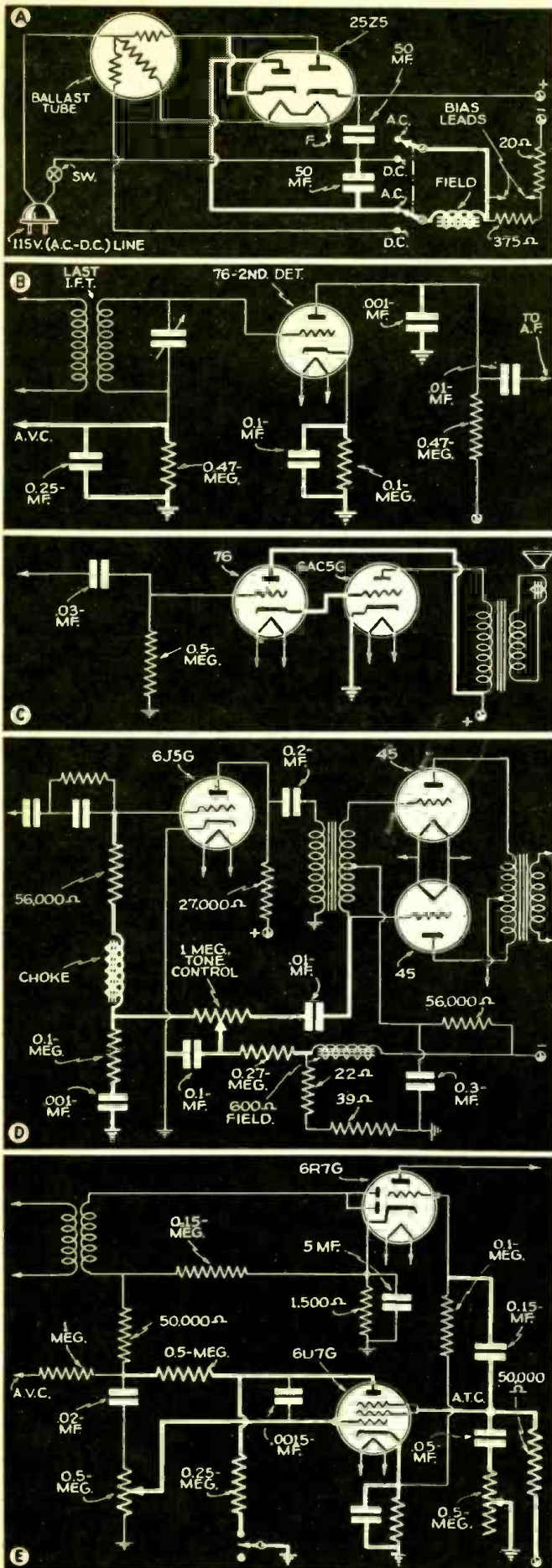

Fig. 1. The heavy lines in the circuits are the points discussed in the text.

# MODIFYING OLDER SETS TO RECEIVE THE 4 HIGH-FIDELITY STATIONS

Service Men are finding new earnings in modifying older sets to receive the programs of these superlative broadcast stations.

ROBERT COBAUGH

**T**HE Federal Communications Commission announced on December 19, 1933, that it had allocated 3 double-width channels of 20 kc. each in the 1,500 kc. to 1,600 kc. band for experimental high-fidelity broadcasting. These channels are 1,530 kc., 1,550 kc. and 1,570 kc.

At the present time only 4 stations throughout the entire United States are licensed to operate in this band! They are: WQXR, New York; KPMC, Bakersfield, Calif., both on 1,550 kc.; KXBY, Kansas City, Mo.; and, WBRY, Waterbury, Conn., on 1,530 kc. The 1,570 kc. channel has not been assigned to date. The results of these experiments have shown that high-fidelity broadcasting is successful and practical. (See "High-Fidelity on Short Waves," in January, '35, *Radio-Craft*, and the February, '35, issue, page 456, for illustration and description of WQXR and the equipment used to obtain and maintain a station frequency fidelity characteristic substantially "flat" from 25 cycles to over 15,000 cycles.—*Editor*)

All of the new sets on the market and those built within the past 5 years, take in this band. Some of these sets have an additional band from 1,500 kc. to 3,000 kc. for the reception of police and amateur stations, and it is possible to use this second band to pick up these high-fidelity stations. However, about 20% of sets in use today are over 5 years old, and do not include the 1,500 kc. to 1,600 kc. band. (Below 1,500 kc., though, are 4 stations which are free from the "crosstalk"—see Fig. 2—encountered on the higher wavelengths.—*Editor*)

Although a great number of new sets are being sold, there is a large number of people who, for one reason or other, cannot or will not buy a new radio, but are quite willing to spend a few dollars on their own in order to make possible the reception of these stations. Many Service Men will find

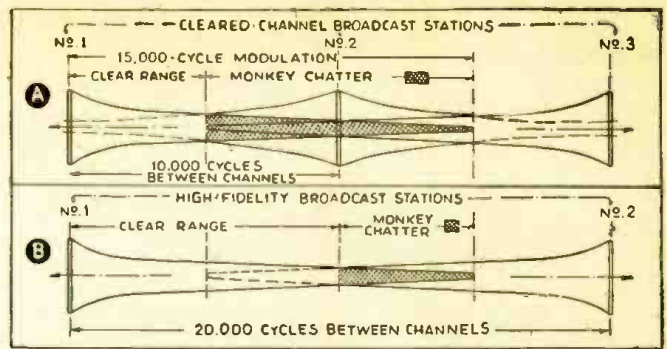

Fig. 2. Crosstalk ("monkey chatter") may be heard between stations 10 kc. apart if the modulation exceeds 5,000 cycles-per-sideband, as shown at A; (note that cleared-channel stations in practice are spaced 50 kc. apart and hence are unlikely to interfere). At B, this proximity has been reduced to nil by carrier allocations that are not less than 20 kc. apart.

## PROLOGUE

In its January 1935 issue, in the article "Hi-Fidelity on Short Waves," *Radio-Craft* told that a new group of 4 stations was blazing new trails with daily broadcasts covering about  $9\frac{1}{2}$  octaves of the musical scale as compared to the 600-odd "standard" broadcast stations which cover only 3 to 4 octaves. Practically all modern sets are designed to tune in these stations, but many owners of older sets do not realize how easy it is for their sets to be modified to receive the super-quality programs they transmit, daily.

that they can profit by this situation. It may, in addition, mean the sale of a set of tubes and possibly an antenna installation. Although the older receivers are not able to reproduce the extended tonal range that the newer type of receivers are capable of, they nevertheless will give good reception of excellent program material available.

Ninety-five per cent of the radio sets manufactured before the year 1929 were unable to tune above 1,500 kc. Approximately 15% did not even reach 1,400 kc. due to large stray capacities such as shielded grid leads, etc. The improved design of radio receivers in recent years has made it possible to build sets with a tuning range from 550 kc. to 2,000 kc.

## ADJUST THE TRIMMERS

Most sets are equipped with padding condensers and trimmers having a range of capacity from 10 to 40 mmf. The most satisfactory way to extend the high-frequency tuning range is by adjustment of the trimmer condensers. (See Fig. 1A.) The ratio of the trimmer capacity to the main condenser capacity will determine the percentage of error introduced into the original dial readings. The error will be greatest at the high-frequency end of the dial and will decrease toward the low-frequency end of the dial by reason of the increasing ratio of the large variable capacity to the smaller fixed trimmer capacity. Adjustment of old sets using 3-element tubes such as the type 26 tube is not always satisfactory because of the poor selectivity of such circuits, especially at the high-frequency end of the dial where the C/L ratio is so low.

## REMOVE TURNS

In some cases where the set is not equipped with trimmer condensers it may be necessary to take turns off each coil. (Continued on page 38)

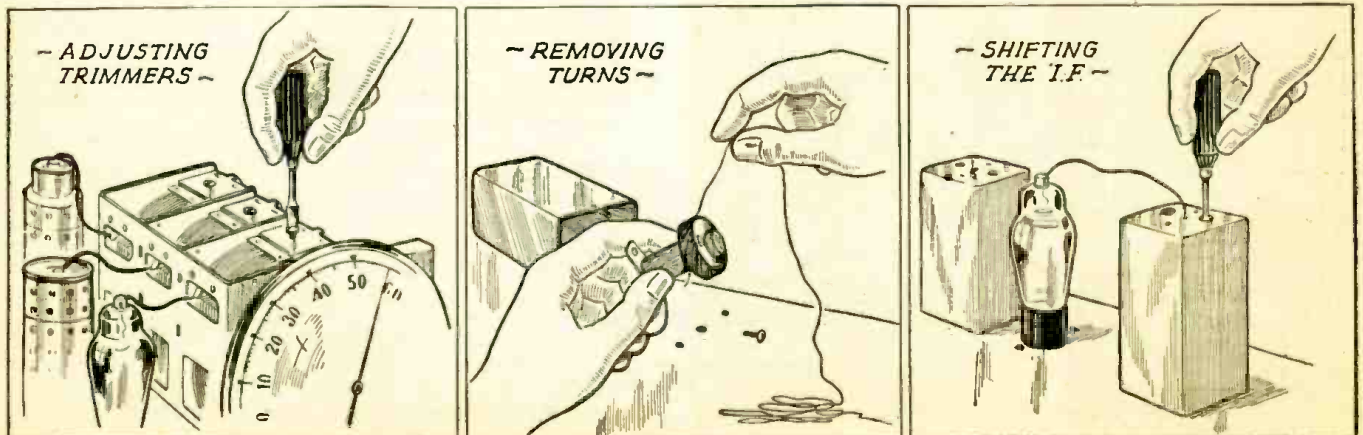

Fig. 1. Service Men are equipped to modify older sets to receive WQXR (New York), KPMC (California), KXBY (Missouri), and WBRY (Connecticut). As shown, the job may entail (A) trimming for higher frequencies, (B) carefully removing turns from coils, or (C) shifting the I.F. to a slightly different frequency.

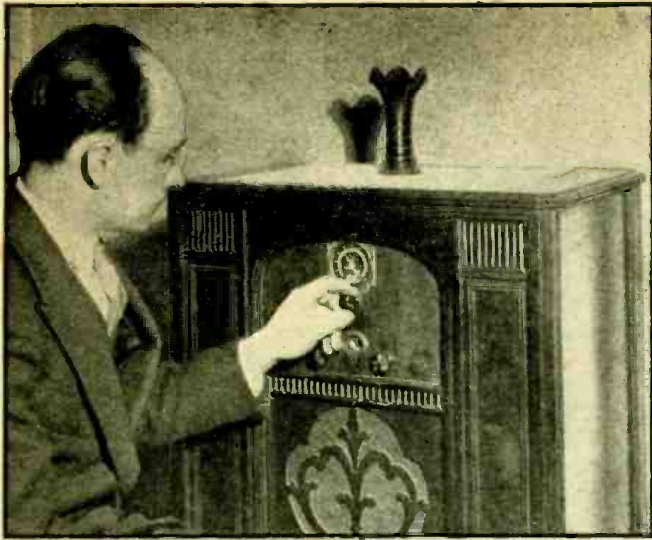

Fig. A. Mr. Palmer operating the completed high-fidelity tuner.

# HOW TO MAKE

Latest developments in radio tuner design are incorporated in this new 4-tube instrument—for the radio set builder, P.A. specialist and Service Man—for the faithful reproduction of local radio programs.

C. W. PALMER

**M**ANY advances have been made in A.F. amplifier design in the past year or so—to mention just a few, the beam-power tube, negative feedback, volume expansion, infinite baffles, peri-dynamic and bass reflex baffles—each of which has its place in the development of really *high* quality reproduction of music and speech. Such an amplifier equipped with good tweeter (high-frequency) and woofer (low-frequency) speakers in an acoustically-treated auditorium or theatre is far better than that obtained with all but *the best of modern radio receivers*.

This statement may bring the wrath of some well-known radio engineers down around the writer's ears, but it is true—as critical listeners can verify. And also true is the fact that a radio receiver is capable of the same high fidelity as that obtained from audio amplifying systems, from the better stations—if certain existing conditions imposed by the listening public can be dispensed with. And these conditions can easily be removed by any rabid seeker after high quality.

It was with these thoughts in mind that the writer set about to design and construct a tuner unit which—without being too complex—would have fidelity characteristics equal to those of a good, modern, Public Address amplifier.

First, a good deal of research was done among the commercial circuits, books and other sources of information on "high fidelity." Many circuits were analyzed and some were built into bread-board setups to answer certain questions. Finally a combination of well-known circuits, some old and some new, were chosen and built into a tuner which satisfies all conditions.

## NEGATIVE MUTUAL COUPLING

First, the well-known "negative mutual coupling" system of tuning which was used in the Western Electric 10A re-

ceiver was chosen. This selector system consists of 4 tuned circuits coupled into 2 pairs of band-pass filters by means of "negative mutual couplings" and capacity in such a manner that a substantially constant band of frequencies is passed, *over the entire broadcast band*. In other words, if the coupling is such that a 10-kc. band is passed at 550 kc. practically the same band separation will be indicated at 1,400 or 1,500 kc. In addition, the pass-band can be easily changed by simply varying the capacity of the coupling elements.

The tuned circuits are over-coupled and while this results in the usual curve of resonance peaks with a dip between, the dip is less than 2 db. which is taken advantage of in flattening the over-all acoustic output of the set, amplifier and speakers. (The last mentioned ordinarily has a dropping off of output at high frequencies which are compensated-for, to some extent, by slight exaggeration in the tuner.)

## INFINITE-IMPEDANCE DETECTOR

A new type of detector is attached to the R.F. end of the receiver. This detector has been named the "infinite-impedance detector" by the RCA Laboratory, where it was designed. This new form of demodulator displays improved characteristics over the diode which—up to now—has been considered in one form or other the criterion in detectors.

The diode has the disadvantages of reflecting a definite—and unfortunately rather low—impedance back into the preceding tuned circuit, thus preventing selective characteristics to be utilized. Also, it is capable of a maximum of some 80% modulation, thus cutting off some of the modulation peaks of a deeply-modulated signal. And last but not least, it resulted in actual attenuation of the signal—instead of a signal voltage *gain* as found in most detectors.

Contrasted to this, the "infinite-impedance detector" reflects very high impedance back into the preceding tuned circuit—it thus permits full selectivity to be realized. It is capable of practically 100% modulation—thus being a better detector than the diode, and it produces a signal gain instead of loss!

Some explanation has been given to the detector as, in the writer's opinion the detector is the bottle-neck or weak link in the chain of individual parts which make up a "hi-fi"

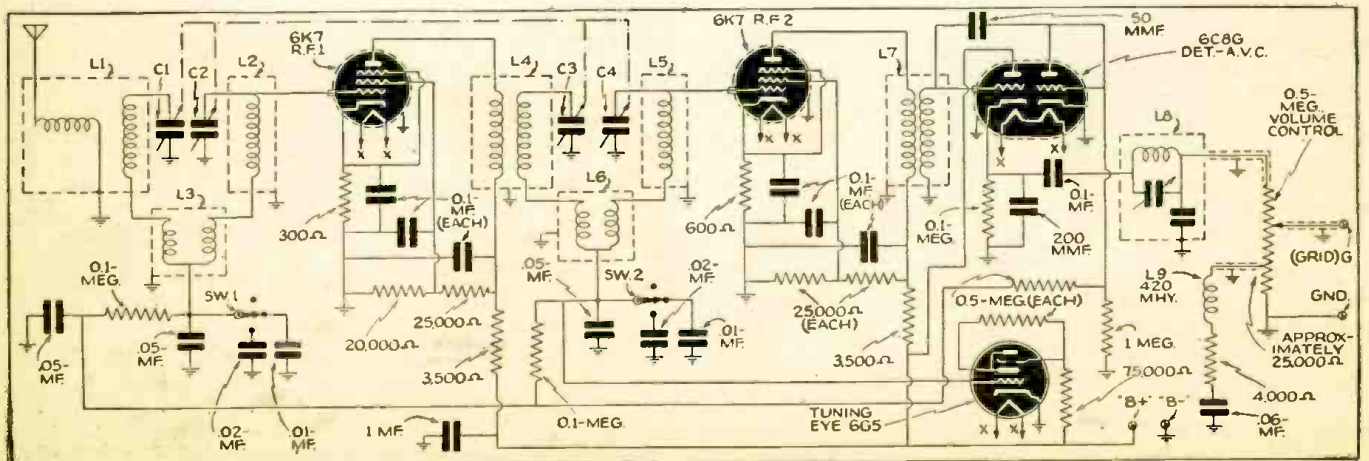

Fig. F. Schematic circuit of the high-fidelity tuner which uses negative mutual coupling in both R.F. stages and bass-compensated volume control.



# A HIGH-FIDELITY TUNER

- Tuned-Radio-Frequency Circuit
- Negative Mutual Coupling
- Adjustable Band-Pass
- Infinite-Impedance Detector
- Tone-Compensated Volume Control
- Automatic Volume Control
- Visual Tuning Indicator
- Monkey-Chatter Frequency Trap
- Controlled Flat-Top Response
- Individual Voltage Dividers

radio set. However, no theoretical explanation of the action of the "infinite-impedance" detector will be given since an article probably will appear in this publication shortly, giving full data on this new and improved demodulator.

## TONE-COMPENSATED VOLUME CONTROL

Following the detector is a form of volume control which has become popular in Europe, but has been neglected in the U.S. in favor of bass boosters, bass compensators and speakers which exaggerate bass response.

This is the "tone-compensated" volume control which consists of a potentiometer tapped part of the way down its resistance with an inductance, capacity and resistance connected between this tap and ground.

The A.F. filter thus formed is tuned to a low audio frequency—about 40 cycles—to increase the low-frequency gain on low volume levels where exaggerated bass response is desirable (for instance, to compensate the falling characteristic of the human ear to low-frequency response at low intensities).

On higher volume levels, bass compensation should not be necessary—or desired—so that the bass boosters sometimes employed should not be required. Experiments verified this assumption—at least as far as the writer's ears are concerned.

The set is equipped with a small degree of A.V.C. though no attempt is made to completely control the gain of the R.F. end of the set—with the thought in mind that complete control would introduce harmonic distortion. In conjunction with this partial A.V.C., a tuning-eye tube is included to permit accurate tuning to facilitate obtaining the high quality possible with the tuner.

The final unit of the set is a 10,000-cycle filter consisting of a tuned trap in the output of the detector to eliminate the "monkey chatter" (cross-talk) which would otherwise be heard in any of the metropolitan areas where the local stations are separated by only 10 kc.

## CONSTRUCTION

From the above sketchy outline of the set's make-up and background it can be seen that much effort and thought have been given to the design and selection of the parts which go to make up the tuner.

Some readers who have become used to the superheterodyne circuits which constitute 9 out of 10 of our modern

receivers, may question the use of a T.R.F. circuit in this tuner. The answer to this question is that *where constant pass-band can be obtained* in a T.R.F.-type set, in a receiver that is designed particularly for "local" reception, and where a flat-topped response that is readily controllable can be obtained, there is no need to increase the complexity of the set by introducing "frequency shift" (superhet.) circuits.

An examination of the circuit (Fig. 1) of the set shows the various parts which have been discussed; plus a few which have not been mentioned, such as the use of an untuned coupling circuit between the 2nd R.F. stage and the detector, the use of a dual-triode in the detector circuit, one section of which is the infinite-impedance detector and the other the diode A.V.C. rectifier.

It will be noticed that *individual voltage dividers* are used for the screen-grid feed circuits. This is done to avoid further delaying the cut-off point of the R.F. tubes so that they will be as linear as possible consistent with the needed remote cut-off action.

The cathode of the 1st R.F. tube is biased with a 300-ohm resistor which permits full amplification of weak input signals at this point. A 600-ohm resistor is used for the 2nd R.F. stage, to prevent overloading at this stage on large input signals. This difference is desirable due to the incomplete A.V.C. action in the set.

The inductance for the compensated volume control can be made at home if desired, or a 420-millihenry coil may be obtained. As shown in Fig. 2, the coil

(Continued on page 41)

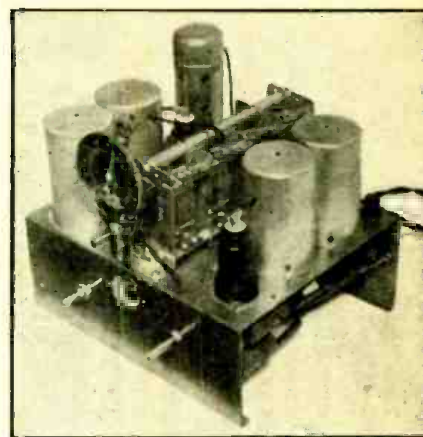

Fig. B. The chassis, neatly laid out and built.

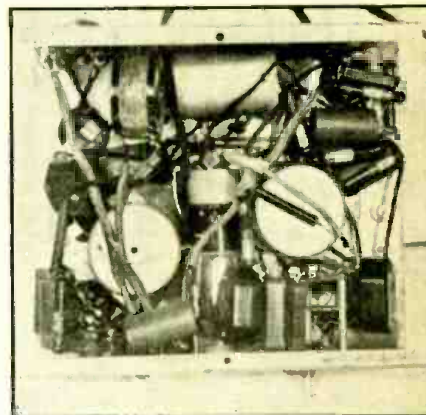

Fig. C. Under-side view of the chassis.

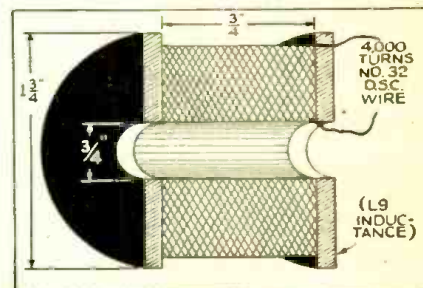

Fig. 2. Winding data for inductance used in the bass-compensated volume-control circuit.

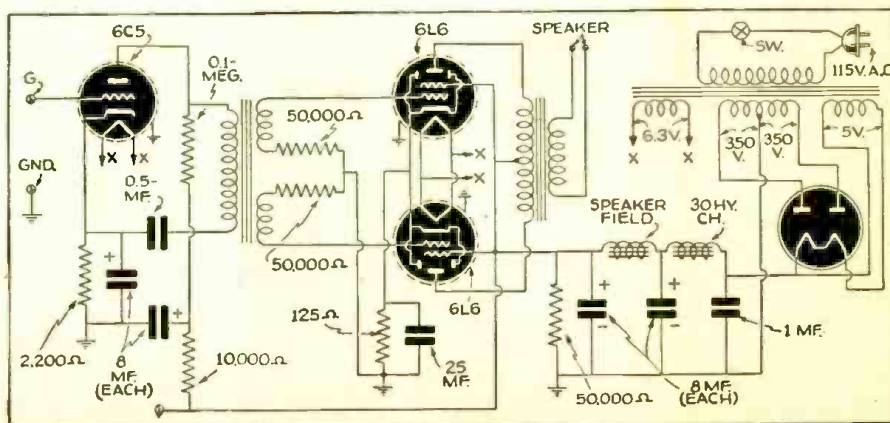

Fig. 3. Circuit of a high-fidelity amplifier which will do justice to the quality of the signal obtainable from the high-fidelity tuner.

# "BI-FONIC"

Not since the "infinite baffle" made its appearance has there been the marked progress, in the principles of sound reproduction, exhibited by this new system — IN WHICH THE BACKWAVE IS UTILIZED.

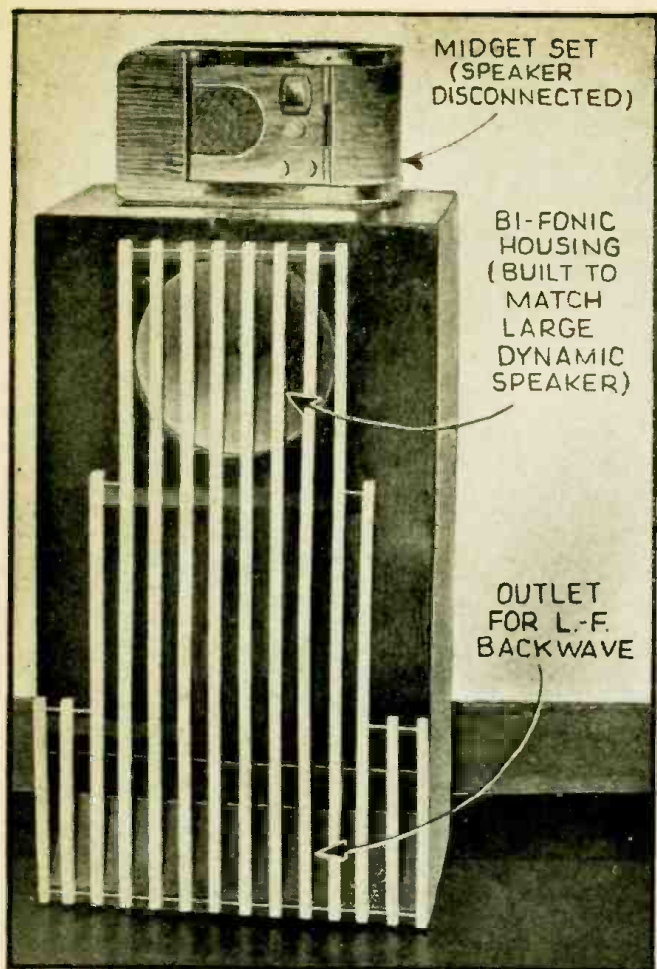

Fig. A

A midget radio set, its output fed to a Bi-Fonic Reproducer, goes "hi-fi."

**SERVICE MEN!**—Here's your opportunity to "sell" that recalcitrant customer, whom you couldn't induce to purchase an entire new radio set, a new housing for his midget set's loudspeaker. The customer gets high-quality reproduction he didn't believe was possible, and you make a profitable sale.



Fig. C

Rear view of Bi-Fonic Reproducer, showing bars, and top of tube No. 1.

**T**HE job of a loudspeaker is to reproduce all musical instruments, the human voice and various other sounds, with as little deviation from the original as possible. To build a loudspeaker which would accurately reproduce one musical instrument is a man-sized job; to build a speaker which will accurately reproduce a whole symphony orchestra is truly asking for a Twentieth Century Aladdin's lamp.

If we are to reproduce accurately the various musical instruments, is it not logical that we **MUST** use the same basic principles of tone generation in our speaker as are used in the various instruments? These fundamental principles are as follows:

**FIRST**—Every instrument is composed of 2 elements.

1. *The vibrating element.* (Such as the string of the violin, the reed of the saxophone, the string of the piano, etc.)
2. *The phase-inverting and tone-developing element.* (Such as the tone box of the violin, the sound board of the piano, the air column of a trumpet, etc.)

**SECOND**—Every instrument has an air displacement in ratio to its place in the musical scale. For example, in the string instruments, the violin, viola, cello and bass viol each operates in a different section of the scale and as they progress downward in frequency they get larger. The bass viol is not louder than the violin but its notes are much heavier. This same principle applies to any other family of musical instruments.

**THIRD**—No instrument contains any means of absorbing the back-wave of the vibrating element. Where the back-wave exists, its envelope is inverted by being reflected from a soundboard, or by being resonated in a tube.

Using these principles as guide posts, and having studied music for 9 years, the author started experiments in speaker

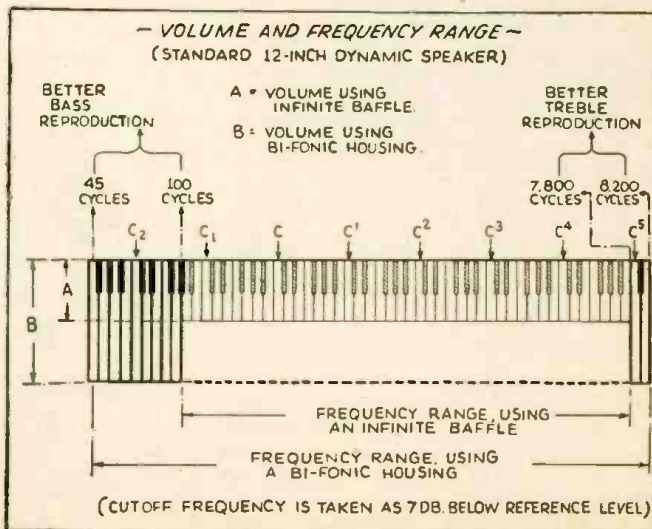

Fig. 1

Increased volume and fidelity are achieved by using a Bi-Fonic housing.

# SOUND MAGNIFIER



ROBERT LIVINGOOD

design, over 2 years ago, which have culminated in the creation of what he terms Bi-Phonic Reproduction (Herein-after spelled "Bi-Fonic."—*Editor*). See Fig. 1, which illustrates the improved frequency response and increased volume this system achieves.

## BASIC PRINCIPLES OF BI-FONIC REPRODUCTION

In the Bi-Fonic Reproducer, shown complete in Fig. A, a conventional cone acts as the vibrating element. The Reproducer acts as the tone-developing element. Together they consist of a box having a cross-section as indicated in the phantom view, Fig. B. The surfaces enclosing the cone are broken up with a series of half-round wood strips. The surface directly in back of the cone, as shown in Fig. C, is composed of several series of alternate vertical and horizontal half-round strips of wood. A slot is left between the bottom and back surfaces. This slot feeds into the first of 3 parallel "tubes" of equal length and cross-section, and constructed of wood, but having end-plates of "lignin plastic" (masonite).

Before explaining the theory of operation of the Bi-Fonic Reproducer, the author desires to stress that *each of these theories was checked, in both theory and practice.*

**FIRST**—In a body of air of given temperature and pressure, sound travels in a straight line and can be reflected like a ray of light.

**SECOND**—The band of audio frequencies reflected can be controlled by regulating the size of the reflecting surface.

**THIRD**—If 2 air columns of the same length, material and cross-section are made to resonate at the same frequency, *but 180 degrees out-of-phase*, the resulting audio output—providing the tubes are laid side-by-side—is zero.

Using these theories, the following functions take place in the Bi-Fonic Reproducer.

(Continued on page 50)

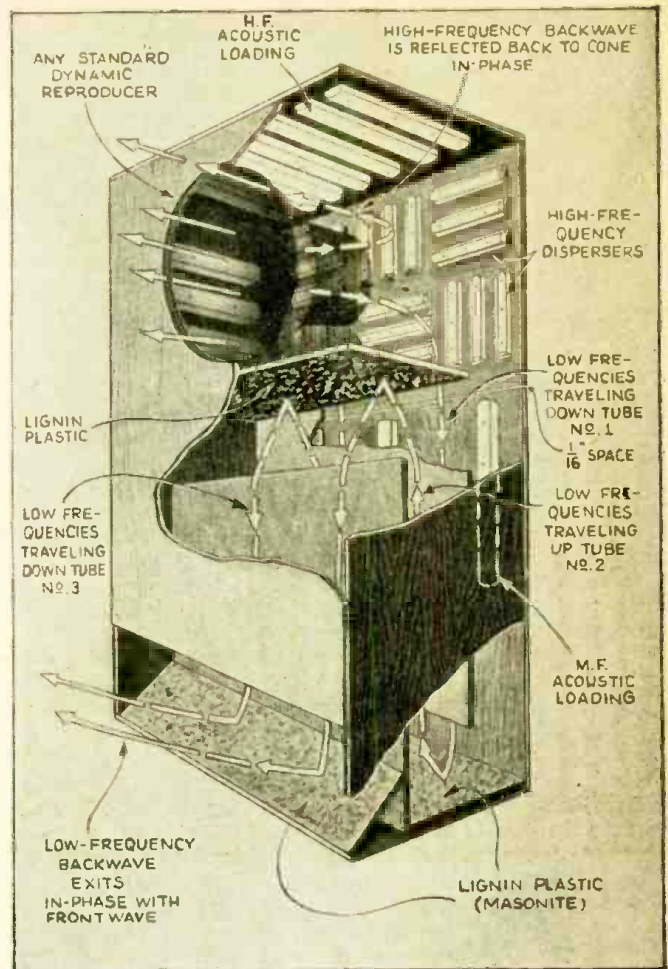

Fig. B

Phantom view of Bi-Fonic Reproducer; sound is reflected, not absorbed.

**PUBLIC ADDRESS SPECIALISTS!**—Here's a sound reproducing system which develops more sound output, for a given electrical input, than does any preceding type of reproducer. Clubs, restaurants, broadcast station monitoring rooms, schools, all are good prospects for this system.

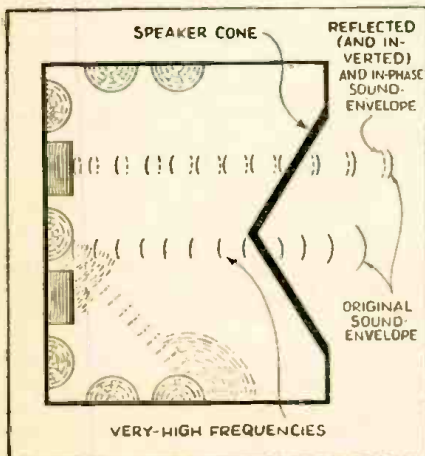

Fig. 2

High-frequency back-waves are reflected in whole off the half-round blocks. Those which reflect into the cone reach the cone in phase-aiding. This results in increased high-frequency response. (The sound envelope practically "folds" inside out.)

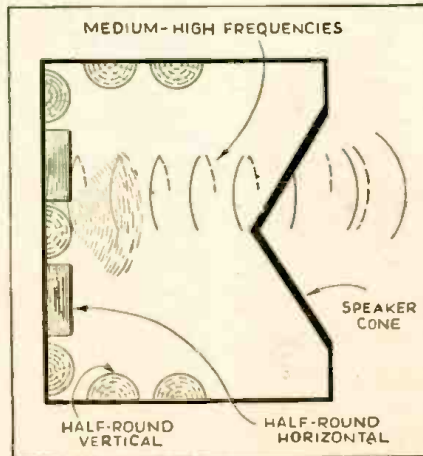

Fig. 3

Medium-frequency back-waves are partly disbursed, in order to reduce "cabinet resonance," so that only a portion of these waves is reflected back to the surface of the cone in phase-aiding. (The back-wall has an air space 1/16-inch wide!)

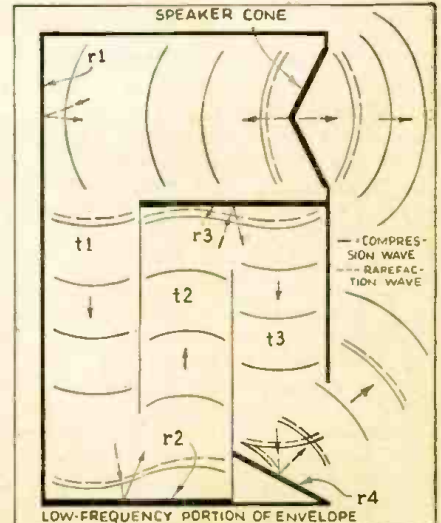
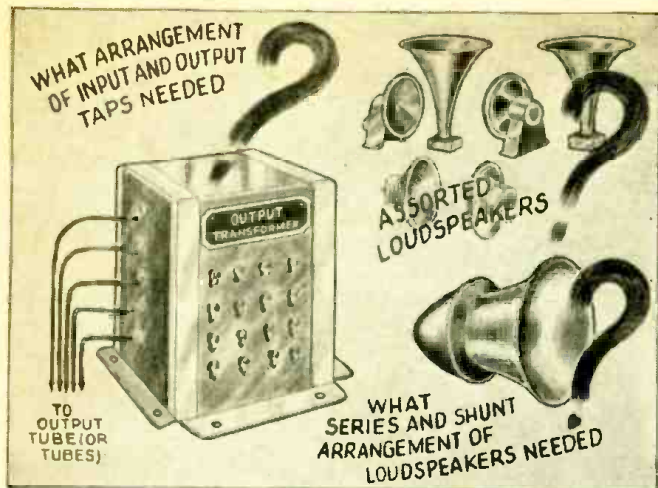

Fig. 4

Low-frequency back-waves exit in phase-aiding.



Given a tapped output transformer (fed from a given output-tube arrangement), and a group of assorted type of loudspeakers, what would be your next step to obtain rated performance from these reproducers?

**T**HIS writer believes (and his attitude is based on experimental verification) that, on the average, one out of 100 radio Service Men, radio operators, Public Address operators, and you can throw in a few engineers for good measure, can solve the following problem:

It is required to calculate the taps on the secondary of an output transformer, giving the impedance in ohms, to accommodate the following 3 groups of speakers:

- (1) Three Magnetics, 5,000 ohms impedance, 0.5-watt (each);
- (2) Two-Standard Dynamics, 15 ohms impedance, 3 watts (each);
- (3) One Large Dynamic, 10 ohms, 10 watts.

Each group is to be placed across one tap. An amplifier is provided with a peak output of 20 watts, whose tubes are to face a reflected load impedance of 6,000 ohms, plate-to-plate. And you must check back to make sure you're right!

None of the radio men in the first 3 classifications whom this writer approached with this problem could do it, and only a very few had any notion what "reflected load impedance" means. The engineers hemmed and hawed, and gave at best incomplete replies. Better yet, this writer went to several first-rate textbooks and manuals, but not one, as far as several hours of looking could disclose, had mention of this topic!

While brochures and analyses on impedance matching can be found by the dozen, none gives the necessary formulas or extensions of reasoning to include this subject, and the writer has yet to see a formula involving *reflected impedance*. It is the hope of this article to throw a little of this spring sunshine on this much neglected topic. Every P.A. operator and Service Man is sure to run afoul of such a problem sometime or other.

#### TAPPED-SECONDARY TRANSFORMERS

(Note that this discussion involves only ordinary grade-school arithmetic; that the bases of ordinary sound considerations here analyzed for the radio and P.A. practitioner are only those elements of the subject without which the technician cannot "get to first base."—*Editor*)

First the diagram (Fig. 1A) to see what we're talking about:

The legend for the diagram is:

- Z-1—total impedance of the 3 magnetics in parallel, equal to 1,367 ohms;
- Z-3—total impedance of the 2 standard dynamics in parallel—7.5 ohms;
- Z-2—impedance of large dynamic—10 ohms;
- Za—impedance of tap for magnetics;
- Zb—impedance of tap for 10-ohm dynamic;
- Zc—impedance of tap for two 15-ohm dynamics;
- Zp—reflected load faced by tubes, 6,000 ohms.

To begin with, there are 2 solutions. Both give the same result, and both fundamentally alike, but, in outer appearance, rather different.

# MATCHING TO TAPPED

## A. COBLENZ

One fact is obvious immediately. The watts power consumed at Z-1, or delivered by Za equals 3 x 0.5, or 1.5 watts.

The watts power at Z-2 is 10 watts, and that at Z-3, twice 3 watts, or 6 watts. That makes a total of 17.5 watts, so that the amplifier can take care of the drain.

Now, it can be shown mathematically, that  

$$Z \text{ of any tap} \quad \text{Watts sec. tap supplies}$$
as

$$\frac{Z \text{ of its load}}{\text{Total Sec. watts}}$$
  
As it is unnecessary to just waste the additional 2.5 watts, the primary will be designed to supply 17.5 watts. In formula form:

$$\frac{Z_s}{Z_o} \text{ equals } \frac{P-t}{P_s}$$

Where P-t represents the watts power consumed at any one tap, and Ps equals the power in the secondary, or supplied by the primary,—17.5 watts. (The losses in the transformer are neglected.)

Or, Zs equals P-t x Zo/Ps.

Thus, for tap a, its impedance is then 1.5/17.5 x 1,667 equals 141 ohms, approx.

For tap b, Z-b equal 10/17.5 x 10, or 5.76 ohms (approx.).

For tap c, Z-c equals 6/17.5 x 7.5, or 2.57 ohms (approx.).

Now that's all very well indeed, but how do you know you're right, and where does the *reflected impedance* shine in? And what is "reflected impedance" anyway? And what do you mean by saying that the impedance of the secondary tap is such and such number of ohms? One at a time, please.

#### WHAT IS "REFLECTED IMPEDANCE"?

*Definition:* Reflected impedance is the resistance in ohms, at the particular frequency under consideration, which the plate or plates, of the output stage face, resulting from the load placed across the secondary. Please note that if the secondary load is 0, so is the reflected impedance.

Now about this impedance question. When the impedance of a unit is specified in audio work, some manufacturers mean that the impedance has been measured at 60 cycles, others 400, still others 1,000. That is, Z equals 2pi fL, or 1-2pi fC, and therefore, unless f is specified, Z can be anything from 0 to infinity! Following the practice of the majority, in specifying Z at a low frequency, and letting the impedances take care of themselves, as they will, for higher frequencies, and also from considerations of convenience, *f is considered as 60 cycles*. However, even if not specified, all that is necessary is to bear in mind that all impedances are measured in terms of the same frequency, and, as ratios of Z are most important in audio work, the frequency will cancel anyway. So, when we say the impedance of the secondary tap is x ohms, we mean that 2pi fL equals x ohms, f being 60 cycles, and L referring to the inductance when leakage, mutual inductance, etc., are all figured in. Now to show you where the reflected impedance harps in!

Every radio man knows (or should know!) that Np/Ns as Ep/Es (primary-to-secondary turns ratio equals primary-to-secondary voltage). He also knows that Np/Ns as  $\sqrt{Z_p/Z_s}$  (primary-to-secondary turns ratio equals the sq. root of the primary-to-secondary impedance ratio). But do you know that the impedance a tap on the secondary reflects into the primary bears the same relation to its load as the impedance of the primary (as the tube plates see it), bears to the impedance of that tap?

Stated in formula form:  $Z_r/Z_o$  equals  $Z_p/Z_s$ . You will note that Zp appears in this formula, and it might look like a case of circular reasoning. But it isn't. For each tube, or tubes, for optimum efficiency, there exists a Zp and

# LOUDSPEAKERS TRANSFORMERS

Many heretofore unpublished "mysteries" of input, output and reflected impedance are here divulged, by a N.Y.C. Police-radio technician, for radio and Public-Address men.

the loads on the secondary are always designed so that this is taken care of. While each tap will not reflect, per se, 6,000 ohms, or  $Z_p$  in this case, into the secondary, all combined together, their reflected impedances functioning in parallel, will reflect the correct impedance. Witness:

$Z_{ra}$  equals  $6,000 \times 1,667/141$  or 70,200 ohms (approx.).

$Z_{rb}$  equals  $6,000 \times 10/5.7$  or 10,560 ohms (approx.).

$Z_{rc}$  equals  $6,000 \times 7.5/2.57$  or 17,520 ohms (approx.).

Now we'll just put these 3 in parallel, and presto!, we get 6,000 ohms within 1 or 2 per cent, allowing for small inaccuracies in the arithmetic.

## A USEFUL NEW EQUATION

There is another method, a simpler one, although the one above is really quite neat, if you care to delve into the mathematics behind it. This second method takes voltages, and ratios, as follows:

Since  $E$  equals  $\sqrt{Zp}$ , the voltage at the primary, and that at the various loads, is readily computed. Thus:

$E_a$  equals  $\sqrt{1.5 \times 1,667}$  or 50 volts

$E_b$  equals  $\sqrt{10 \times 10}$  or 10 volts

$E_c$  equals  $\sqrt{7.5 \times 6}$  or 6.7 volts

$E_p$  equals  $\sqrt{17.5 \times 6,000}$  or 324 volts

Now we'll just recall one of the formulas every radio man should know, shown above. Namely:

$\sqrt{Zp/Zs}$  equals  $Np/Ns$  equals  $E_p/E_s$  and obviously  $Zp/Zs$  equals  $E_p^2/E_s^2$

And away we go:

$Z_a$  equals  $2,500/10,500 \times 6,000$ , or 141 ohms

$Z_c$  equals  $100/10,500 \times 6,000$ , or 5.7 ohms

$Z_c$  equals  $45/10,500 \times 6,000$ , or 2.57 ohms, remarkable, my dear Watson.

But to check, you must go back to our old friend shown above, namely  $Z_r/Z_o$  equals  $Z_p/Z_s$ .

The author cannot refrain from noting, in conclusion, that this last given formula he has never seen or heard of, from any one, and no publication that has come to his attention, after ex-

## CAN YOU SOLVE THIS PROBLEM?—

"It is required to calculate the taps on the secondary of an output transformer, giving the impedance in ohms, to accommodate the following 3 groups of speakers: (1) 3 Magnetics, 5,000 ohms impedance, 0.5-W. (each); (2) 2 Standard Dynamics, 15 ohms impedance, 3 W. (each); (3) 1 Large Dynamic, 10 ohms, 10 W.

Each group is to be placed across one tap. An amplifier is provided with a peak output of 20 W., whose tubes are to face a reflected load impedance of 6,000 ohms, plate-to-plate. And you must check back to make sure you're right!"

In "Matching Loudspeakers to Tapped Transformers," Mr. Coblenz gives you the solution to this and many other problems concerning the matching of A.F. impedances.

haustive hours in the 42nd St. Library, Technology Division, has even hinted of its existence. That it is a logical outgrowth of the well-known formula of turns-ratio and impedance-ratio is granted, but just in this form, so useful for these common computations, he has never seen it.

## "WATTLSS" or "QUADRATURE" POWER

One more very interesting observation. To such misguided, but well meaning, radio men who picture impedance matching as  $x$  ohms across  $x$  ohms, the sight of, say, 1,667 ohms across 141 ohms, as in tap A, or of 2.57 ohms across 7.5 ohms, as in tap C, must be a horrible sight indeed. It has been the author's experience that radio men picture impedance matching as ohm for ohm, and allay their objecting consciences by saying, "Well, I'm talking impedances, ain't I?"

But please consider this: A pure inductance or capacity neither absorbs nor gives out power. It is only the component of current in-phase with voltage that represents power loss, "the component in quadrature" is what we call wattless, or "quadrature" power. You do not match impedances to that because it has no power to deliver. True, the component of current in quadrature with the voltage increases the re-

sultant current, and increases thereby copper and other losses. But, in power transfer, you only match to the component of the inductance which represents actual power, its current in-phase with the voltage, and the impedance of the entire inductance is not entirely effective in delivering power. Hence, the fact that 141 ohms is paralleled by 1,666 ohms, or 7.5 by 2.57, does not of necessity indicate a mismatch. In fact, this particular system as given is quite well matched.

## EXAMPLE OF SEEMING MISMATCH

To illustrate even more strikingly an arrangement which the average radio man would immediately condemn as a glaring example of poor engineering involving a mismatch, consider the following diagram (Fig. 1B). By actual measurement, at 60 cycles,  $Z_p$  equals 20,000 ohms,  $Z_s$ , 5,000 ohms, and  $Z_l$ , 1,500 ohms.

Every radio man knows that for maximum power transfer from tube to output, the load  $Z$  must equal  $R_p$ . Now what self-respecting power tube, in common use, and delivering 2 watts or more, say, has an  $R_p$ , or rated load  $Z$  for maximum output as given in tube charts, of 20,000 ohms? All right, you say for "optimum fidelity" the load should be twice  $R_p$ ? Fine. Look at your tube charts, and see that for power tubes as common as 6L6, 10, 50, 45, 2A3, 2A5, and, of course, for higher power tubes as used in transmitters,  $R_p$  varies from 1,500 to 5,000. Thus (and the same tube charts will also tell you this), for stated output, the load  $Z$  approximately equals double this value. And what's worse, look at the secondary— $Z_s$  is equal to 5,000 ohms; and load, 1,500. How awful! Well, it isn't awful, and there is no mismatch here; in fact, it's a mighty good matching arrangement! Let's see:

According to the little formula involving reflected impedance as given above, the impedance reflected into the primary as a result of the load, is  $1,500/5,000 \times 20,000$ , or 6,000 ohms.

(Continued on page 51)

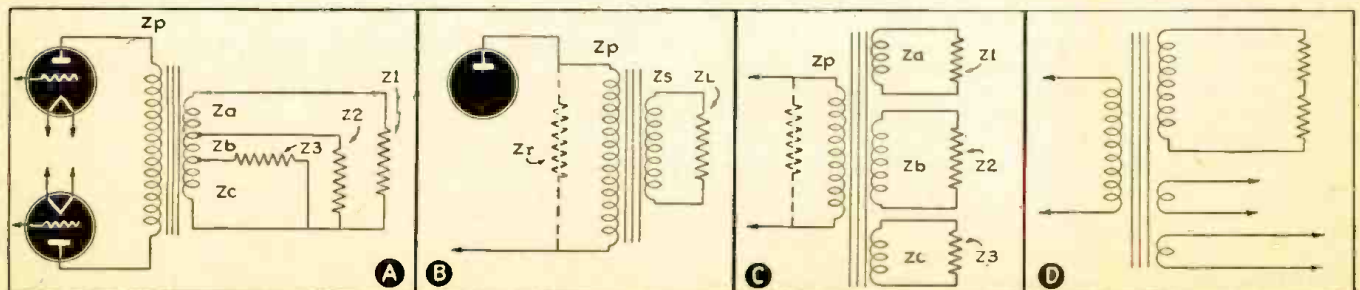

Fig. 1. "Equivalent diagrams" of effective impedances. A—3 magnetic loudspeakers, 2 standard dynamics and 1 large dynamic, connected to single, tapped secondary; B—glaring example of "mismatched" impedances; C—matching assorted speakers to multi-secondary transformer; D—showing importance of reflected impedances. In general,  $Z_s$  indicates impedance of any one sec. tap;  $Z_o$ , load imp. on or across it; and  $Z_r$ , reflected load imp.



## UNIFIED P. A. EQUIPMENT

In this article the author answers 2 questions: (1) in what way does modern sound equipment differ from earlier apparatus; and, (2) in what manner does modern sound equipment help increase earnings?

HARRY PARO

**H**AVING grown from an experiment to a mature industry, the Public Address business now requires that sales and merchandising procedures, and even technical problems, be handled differently than they were only a few years ago. To maintain a proper level of profit, the identical Public Address job is done differently than it was in the past, and on a far more business-like basis.

For example, it was common enough in earlier days to spend \$50 worth of time experimenting over a rental installation that paid only \$50 altogether. A job of that sort might be summed up this way: value of time, \$50; true value of equipment rental, \$25; sales cost and overhead, \$25; \$100 worth of value given, \$50 payment received. By considering his time and skill worth nothing, the P.A. man just broke even; by charging his P.A. overhead and sales costs to other business activities, such as Radio Repair or Sales, he might delude himself with the fictitious idea of a \$25 "profit". That was one of

the inevitable penalties of pioneering; and not all loss, for the P.A. man who undertook such deals was at least acquiring experience in a field which (then) was not so well known.

### PUBLIC ADDRESS GROWS UP

Profits today are more substantial. The entire business is on a different basis. For one thing, there is more of it, and overhead, charged properly where it belongs, is minimized by division among a much larger number of P.A. rentals and sales. Sales cost also is lower; there is more competition, but much less canvassing among a disinterested public inclined to regard P.A. as an unreliable toy. The general public now knows and wants P.A. and competitive features are provided by the manufacturers of equipment at no appreciable cost to the P.A. merchant, as will be seen.

Above all, there is practically no need now for experimentation on the job, except in extraordinary cases. In

(Continued on page 52)

## WAX & OIL CONDENSERS IN RADIO SERVICE WORK

Given a defective radio set, with trouble traced to a defective wax- or oil-dielectric condenser, what steps would you take to determine the capacity, rating, or other unknown data, needed in making replacement?

WILLIAM BAILEY

**I**N servicing radio equipment of modern design, let us assume that faulty condensers are found without much trouble. We will deal strictly with the next step—that of determining the type of unit causing the disruption of operation. For instance, there are (referring to the dielectric material) wax, oil, mica, electrolytic and air (trimmer) condensers.

In this article we will consider only the first 2 types, "wax" and "oil." It is obvious that there is a marked electrical difference between these 2 types, although their physical appearances, as the illustration above of representative types shows, are not so different as to facilitate their identity.

Of course, if the unit is plainly and properly marked, there is little trouble today in securing the replacement, providing the set being serviced is one of reputable make. However, should this means of identification be lacking, it then becomes the Service Man's job to find out the electrical characteristics of the unit itself, namely: capacity toler-

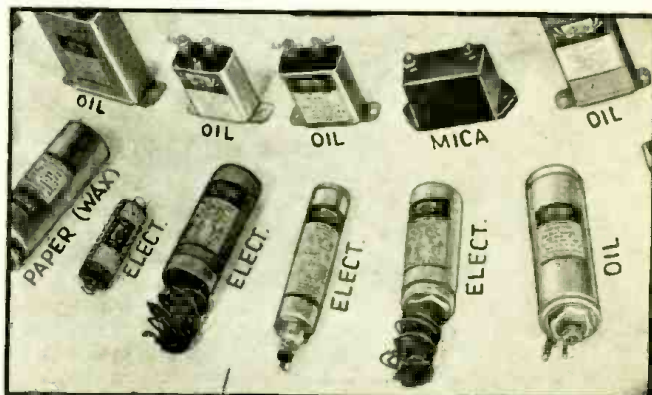

ance; inductive and non-inductive sections; and whether the unit is a "wax," "oil" or "electrolytic."

### CHECKING FOR "WAX" OR "OIL"

Many wax and oil units closely resemble electrolytic condensers in external appearance. The Service Man should make absolutely sure which are electrolytic and which are wax- or oil-impregnated units before attempting to make any definite replacement. This can easily be accomplished by checking the leakage through the condenser. If the leakage is in the order of milliamperes, it is of the electrolytic type. If in the order of microamperes, it is paper.

In making tests, the Service Man should test for open-circuits, short-circuits or, should the condenser be of a dual nature, shorted sections. Other possible conditions to be checked are: shorted section with ground; high terminal leakage; oil or wax leakage; and, overloading due to some high transient setting up a peak voltage, when the peak

(Continued on page 54)

## SERVICE MEN—

What faults have you encountered in late-model radio sets? Note that *Radio-Craft* will consider your Operating Notes provided they relate to CHARACTERISTIC (repeatedly encountered) faults of a given set model. Illustrations are desirable. Payment is made after publication of the Operating Note.

# OPERATING NOTES

## —ANALYSES of RADIO RECEIVER SYMPTOMS

**RCA Victor 121, 122.** Intermittent reception on these models has been traced to open-circuiting 0.05-mf. bypass condensers, employed as grid filters in the R.F., 1st-detector—oscillator and I.F. secondary-return circuits. The intermittent condition is characterized by a sudden drop in volume and resonance hiss. In one instance, an open-circuited I.F. grid filter condenser introduced a certain amount of motorboating and oscillation upon the high frequencies.

When any one of these receivers is serviced for the complaint of stations being received at two points about 20 kc. apart with distortion between these two points, check the I.F. grid filter condenser for a short-circuited or leaky condition. These symptoms will be apparent only with the volume control turned well up when this failure occurs. See Fig. 1 for location of these condensers.

BERTRAM M. FREED

**RCA Test Oscillator Type TMV-97.** When this instrument goes "dead" you will find the primary winding of the modulation transformer "open" which is caused by electrolysis arising out of the difference of potential between the core and the primary winding.

In replacing the transformer it is best to remove the difference in potential between the core and the primary winding by insulating the core and the mounting strap from the chassis by using suitable fibre washers, and by wiring a jumper wire from the mounting strap to "B+" so that the core is at the same potential as the primary winding, thereby eliminating a source of electrolysis. It is suggested that this precaution be taken before the instrument goes dead.

LEO J. DRAUS

**Airline 62-106, 62-107, 62-121.** Where a condition of very low or no D.C. voltage at all exists at the tube socket terminals, check for a shorted 0.1-mf. tubular bypass unit connected from the plate supply lug of the 3rd I.F. transformer to ground. This condenser is rated at 400 volts and is really connected in parallel with the first filter condenser (16 mf.) at which point the voltage surge exceeds 400 volts each time the set is turned on. Be sure to use a 600-volt replacement. See Fig. 2.

**Airline 62-134, 62-139.** Another short-lived tubular bypass condenser is found in these models. This is a 0.25-mf. unit rated at 200 volts and is used in parallel with a 6 mf. electrolytic con-

denser from screen-grid to ground. Replace with a rating of not less than 400 volts.

**Apex 7.** In these receivers above Serial No. 1,074,054 the oscillator 600 kc. trimmer has been omitted and is replaced by a condenser of fixed value. Quite often this condenser will lose some of its original capacity and cause very weak reception from about 750 to 550 kilocycles.

If this condition is encountered, replace this condenser with approximately a 775 mmf., mica-type unit shunted by various small capacities beginning with 20 mmf., until the right combination is found, or better still, add an 85 mmf. trimmer in parallel with the 775 mmf. condenser and adjust for maximum signal at approximately 600 kc.

**Atwater Kent 82.** Noise when chassis is tapped, similar to that of a microphone tube. Coil shield over I.F. transformer may be loose. This must be absolutely tight. It is wise to drill these shields to pass an aligning tool. Replace shield, and bolt or solder it to chassis. Check alignment of I.F. trimmers at 130 kc.

**Echophone S-4.** Oscillation not due to dirty condenser wiping contacts or faulty bypass condensers may be cured by replacing the 0.5-meg. resistor from detector screen-grid to ground. This resistor is the smallest one mounted on the resistor panel and when open will increase the detector screen-grid potential by about 15 volts, thus producing circuit oscillation and low volume.

VICTOR I. DUDLEY

**Majestic 15, 15B.** A common complaint with these receivers is a dead set due to open I.F. transformer primaries. This is apparent by a lack of plate voltage at the autodyne detector-

oscillator or at the I.F. amplifier.

A peculiar motor-boating hum at the extreme low-frequency end is due to an open input filter condenser. Inspect the grounding connection before removing the unit. This condenser may blow, the 80-tube's plates will then get red-hot.

The grounding plate at the rear of (Continued on page 55)

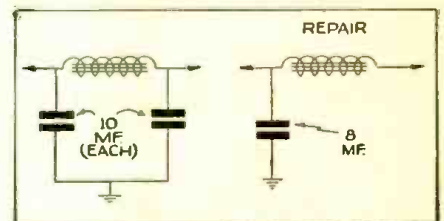

Fig. 4. Chevrolet Model 500,565; the dried-out 10-mf. electrolytics replaced with single 8-mf. unit.

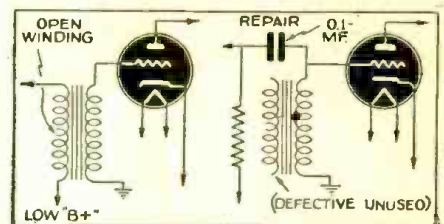

Fig. 3. Sparton Model 913; open A.F. transformer bridged with resistor and condenser. Works OK.

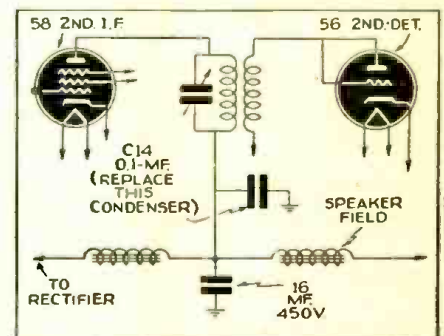

Fig. 2. Airline 62-106; replace shorted 0.1-mf. condenser with one rated at 600 W.V.

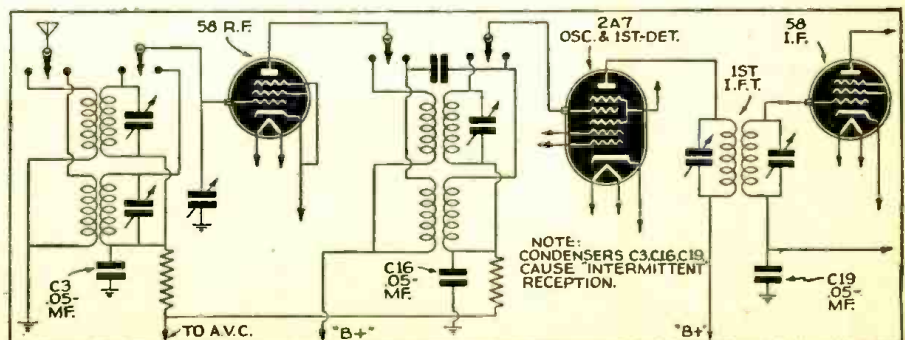

Fig. 1. RCA-Victor Models 121, 122; intermittent reception traced to open 0.05-mf. bypass condensers in the grid-return circuits of the Antenna, R.F. and 1st I.F. circuits.

# USEFUL CIRCUIT IDEAS

Experimenters: Here is your Opportunity to win a prize for your pet circuit idea, if it is new, novel, and useful.

**AWARDS IN THE CONTEST**  
**FIRST PRIZE** ..... \$10.00  
**SECOND PRIZE** ..... 5.00  
**THIRD PRIZE** ..... 5.00  
**Honorable Mention**

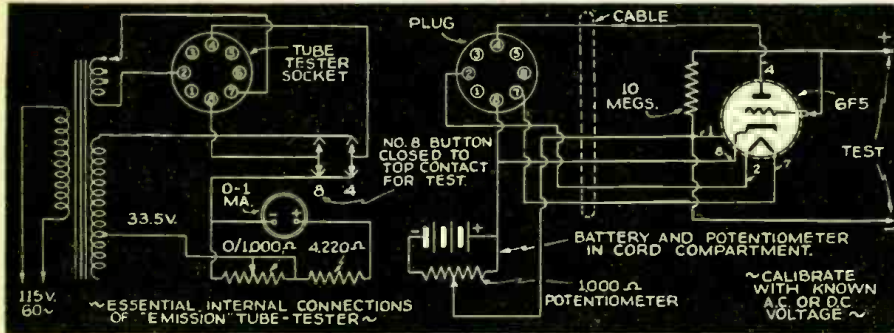

Fig. 1. Any emission-type tube tester may be used as a vacuum-tube voltmeter.

loosened and then with the A.C. ripple still being reproduced the centering screws should be tightened. The voice coil will be perfectly centered. This arrangement is much more convenient than the method of disconnecting filter condensers in the set in order to produce hum.  
 SAMUEL H. BEVERAGE

## HONORABLE MENTION

**RESISTANCE-CAPACITY BOX.** I have been a reader of your publication for a number of years and enjoy it very much.

I am herewith inclosing a diagram of what I term one of the handiest pieces of equipment around our shop. As can be seen from the diagram any resistance value from 200 ohms to 2 megs. may be had by merely operating the switch; but in addition to this, any one of these values may be varied to any desired value by the use of the variable control in the negative leg of the circuit. The 3 decks make it possible to name a deck for low values of resistance, a deck for high values, and a deck for condensers; which means that the whole thing is in one box, with only one switch. See Fig. 4.

A neat 3 scale dial plate can be drawn for the switch and the volume controls may be calibrated or the regular plates purchased for them.

When repairing a set I manipulate my condenser switch for different values of condensers at different points of the receiver. You will be surprised at how much improvement you can make in the receiver with a few extra condensers.

Another place where the condenser resistor box saves time is in cases of open high-value resistors. If you are in doubt about a resistor of high value and your ohmmeter will not measure that high, then set your resistor switch to the value needed and go directly across the resistor in doubt, and also sometimes you will find an open resistor; which is not color-coded and the service manuals do not give the value. From your tube characteristics chart or other data determine what voltage or current you should have, connect a volt or current meter to the circuit and place the test leads from your condenser resistor box across the open resistor and vary the resistor switch until you find a resistor that gives nearly the voltage or current wanted, if necessary you may cut in the volume control and bring the exact amount of resistance in. Also you can experiment with resistors in load circuits and greatly improve a receiver.

You will find many additional uses for this condenser-resistor box.

E. A. MARCHANT

## HONORABLE MENTION

**HOME-MADE VERSATILE TEST METER.** Here is my pet circuit of a very useful instrument which can be used in many different ways. Am submitting it as a circuit short-cut in your contest. See Fig. 5.

First the 0-5 (or any other voltmeter with suitable scale) may be used externally. Jacks 1 and 4 may be used to increase range of voltmeter. Also 1 and 5 may be used for next highest range; adjustment of series resistors in each

(Continued on page 40)

## FIRST PRIZE—\$10.00

**TUBE TESTER AS V.-T. VOLTMETER.** Almost any emission-type tube tester may be used as a fairly accurate vacuum-tube voltmeter. With the use of a 1,000-ohm potentiometer and a 4½ V. "C" battery a wide variety of different tube types may be used. An adapter is made for the tube to be used with the grid circuit left open. If grid connects to top cap, no adapter is needed. I used a type 6F5 since it has a top cap which can be used as a probe and the socket can be connected to a plug and cable for high-frequency measurements. My instrument is a Supreme 89D and the circuit is shown in the diagram of Fig. 1. Calibration curves can be made to suit the instrument used.

WILLIAM WILSON

## SECOND PRIZE—\$5.00

**A 6E5 REPLACES PHONES ON CONDENSER ANALYZER.** I have been a constant reader of *Radio-Craft* since 1930 and have all the copies bound in volumes and the entire set is card-indexed. I believe *Radio-Craft* to be the finest of its kind ever to be published for the service profession. I should like to contribute the following to the Service Men who built or bought the Thordarson Condenser Analyzer as I know that the phone method of minimum hum was, and is, tiresome to use.

I conceived the idea that the "eye" tube (6E5 or 6G5) might take the place of the phones and found that it works very well, and is very compact and light as I use a 25Z5 in a voltage-doubling (transformerless) circuit. I trust that others may find this an easier way to balance the bridge. See Fig. 2.

H. A. WIRSCHING

## THIRD PRIZE—\$5.00

**NEON BULB HELPS CENTER SPEAKER CONE.** I like your fine magazine very much, especially the "Analyses of Radio Receiver Symptoms—Operating Notes," as I am a Service Man. I have a kink which you may find a place for. It is for centering dynamic speaker cones. It consists of a 110-V. neon bulb in series with the speaker output transformer primary and the A.C. line (see Fig. 3). A low-pitched hum will be reproduced. The centering screws should be

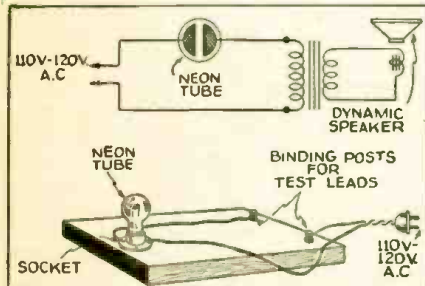

Fig. 3. Neon bulb helps center speaker cones.

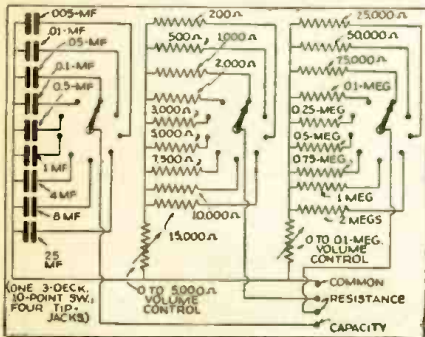

Fig. 4. Resistance-capacity box saves time.

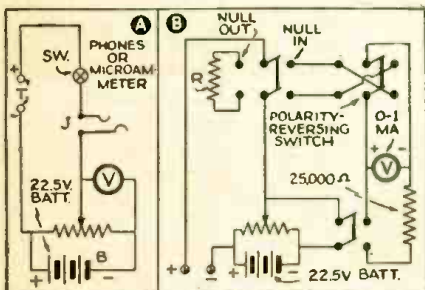

Fig. 6. Measures A.V.C. circuits accurately.

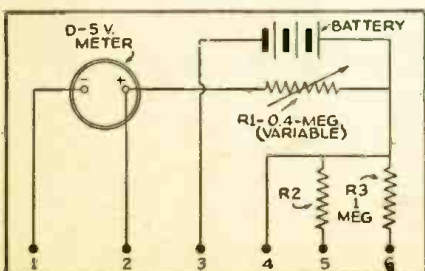

Fig. 5. Versatile home-made test meter.

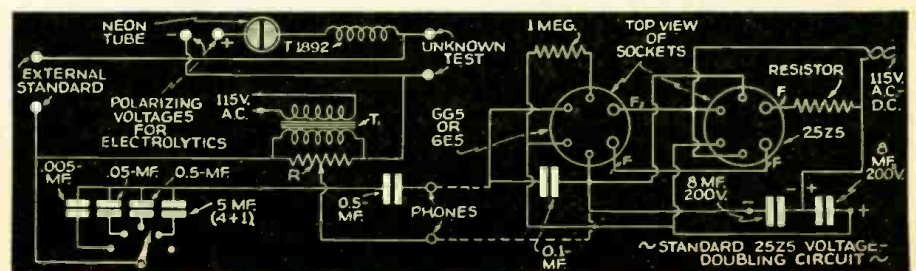

Fig. 2. Affords visual indication of bridge-circuit balance in a condenser analyzer.





## A WIRED-RADIO "NURSEMAID"

Does Baby need a diaper change? Is Baby breathing normally? Every mother is a logical prospect for this "Nursemaid," which gives instant reports of remote happenings. Saves steps.



**H**ERE, illustrated above, is a variation of the wired-radio type of inter-communicator, in which only 1-way operation is possible, which Radio-Craft has termed the "Wired-Radio Nursemaid."

This 2-unit, super-sensitive sound amplifying system utilizes at the pick-up end a "Guardian Ear" which contains a condenser-type microphone, speech amplifier, and modulator-oscillator circuit as shown pictorially by inside view in Fig. A and schematically in Fig. 1. The generated signal is conducted—from baby's room, let us say—by means of the lighting circuit—to

mother in the kitchen, perhaps—and intercepted by the "Radio Nurse" unit shown by inside view in Fig. B and by diagram in Fig. 2. The latter unit is composed of a detector, audio amplifier and reproducer.

Total amplification from microphone to speaker is on the order of 500,000 times. This gain provides a measure of sensitivity capable of amplifying the slightest sounds. Being purely a sound amplifier no attempt is made to attain high fidelity or high power output. This device is NOT an inter-communicating system nor intended to be used as such. Its use is primarily for the nursery or

sick room. Any attempt to obtain great volume by speaking loudly directly into the Guardian Ear will result in serious distortion and speaker rattle.

To test or demonstrate the Radio Nurse elsewhere than in a home the Guardian Ear must be placed in a soundproof box or separate room. This will prevent howling or feedback which normally results from an amplifier where the speaker and microphone units are in close proximity.

The R.F. carrier of 300 kc. is generated by the oscillating S.-G. and plate circuits and coupled to the light  
(Continued on page 38)

## INTRODUCING—A 5-METER CONVERTER

At long last we are able to announce a self-contained, add-on converter which enables any T.R.F. or superhet. receiver to tune-in 5-meter experimental programs.

**M**OST radio sets today are capable of tuning-in not only the extended broadcast band of about 540 to 1,570 kc., but also one or more short-wave bands. However, very few modern radio sets are capable of tuning-in stations below a frequency of about 30 megacycles (10 meters).

An add-on unit which therefore is welcome, and which makes it possible to receive stations transmitting in the 5-meter (60-megacycle) region, is the 2-tube "5-meter converter" here illustrated pictorially (Figs. A and B) and by diagram (Fig. 1).

Of what use is this converter?—What sort of stations will this converter tune-in?—Does any special interest attach to the programs of these ultra-shortwave stations? We will brief the replies to these questions.

(1) A converter of the type here shown affords a particularly convenient means of transferring 5-meter signals to a wavelength slightly below the standard broadcast band. The converter is completely self-powered and is interposed between the regular antenna and the broadcast set. Consequently it is unnecessary to tamper with the inside wiring of the set either to supply power to the converter tubes, or to connect the converter to the input circuit of the regular radio set.

(Continued on page 49)

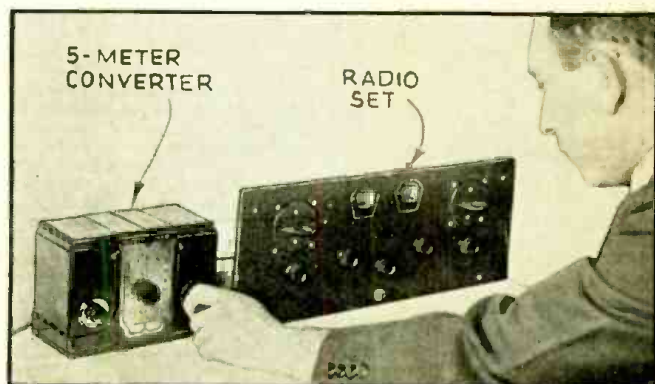

Fig. A. It's now easy to tune-in 5-meter music on broadcast sets!

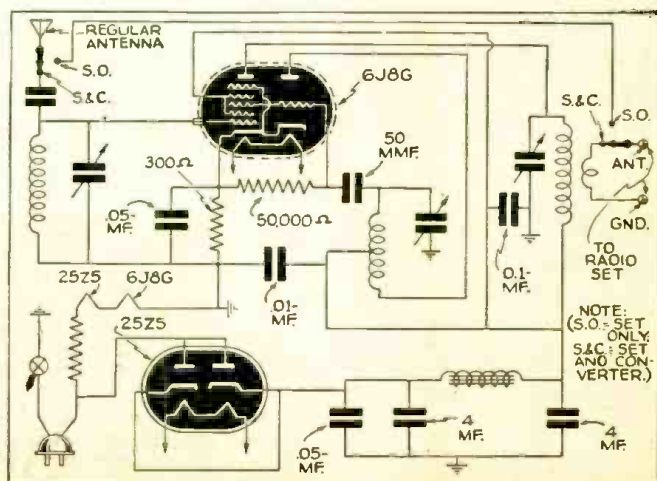
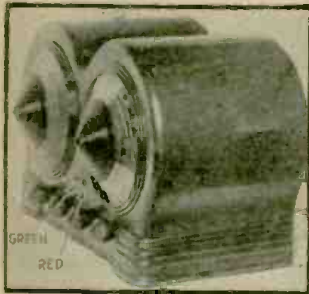

Fig. 1. A simple but effective converter circuit is used.

# THE LATEST RADIO EQUIPMENT

Technicians utilize this department to keep posted on the newer and better ways of doing things in Radio, Electronics, and Public Address.



## NOVEL SET DESIGN INCORPORATES UTILITY (1615)

WHAT is said to be an entirely new thought in radio cabinet styling is here illustrated (top, exterior view; bottom, interior). The "miracle dial" is conically designed to facilitate reading from any sitting or standing position; the scales and numerals are clearly calibrated and the entire dial floodlighted. The loudspeaker has been styled to match. Chassis utilizes 6 tubes and an A.C.-D.C. superbet. circuit for American and foreign reception. Has A.V.C., tone control, beam power tube, jewel band indicator.

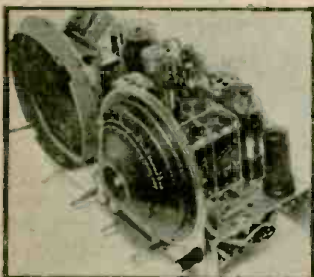

At last one manufacturer has altered conventional receiver design in presenting the above illustrated set. (1615)



## NEUTRALIZING CONDENSER HAS MICROMETER ADJUSTMENT (1616)

A NEUTRALIZING condenser with a capacity range of 2 mmf. to 8 mmf., and a precise means of adjustment, is now available for the radio amateur and experimenter. Plates are 3/16-in. thick, and ground and polished to provide for maximum breakdown voltage with minimum spacing between plates. A knurled lock-nut holds the movable plate rigid.

Vernier adjustment and permanent setting are afforded in an air dielectric neutralizer for transmitters. (1616)



Inexpensive add-on electric phonograph for your home-radio set. (1617)

## IMPROVED ADD-ON RECORD PLAYER (1617) (RCA Manufacturing Co.)

THE MODEL R-93-C, new low-priced record player, here shown, is designed to provide a good-quality record reproducer for new converts to recorded music and for high school and college student record enthusiasts. The Service Man easily connects this unit into any electrically-operated radio receiver. Device incorporates lightweight crystal pickup; tone arm is true-tracked; newly developed motor has bearings and supports cushioned in rubber for quiet operation; volume control and power switch are in one unit.



This add-on power stage conveniently supplies additional output power. (1618)

## ADD-ON POWER STAGE (1618) (Allied Radio Corp.)

THERE is now available in either 25-W. or 60-W. rating a power stage which may be added to any existing radio set or P.A. amplifier. Affords proportionate increase of output power without the expense of purchasing an entire new amplifier. Both units employ 2 type 6L6G beam power tubes, inverse feedback, built-in driver stage, speaker selector switch and facilities for using any P.M. dynamic or self-excited electrodynamic speakers. Tube complement: 25-W. power stage—1-6N7G, 2-6L6G, 1-5V4G; 60-W. power stage—1-6E6, 2-6L6G, 1-5V4G, 1-83.

## MIDGET TRANSFORMERS GET MODERNISTIC COAT (1619)

(Amplifier Company of America)  
A COMPLETE series of compact audio-frequency transformers, designed for all circuits operating up

to a  $\pm 10$  db. level, has just been announced. These units employ a permalloy core and are designed for frequency response of  $\pm 1$  db. between 40 and 13,000 cycles! Dimensions,  $1\frac{1}{2} \times 1\frac{1}{4} \times 2$  ins. high. Special units are designed to order; and with (illustrated), or without, modernistic-styled magnetic shield.

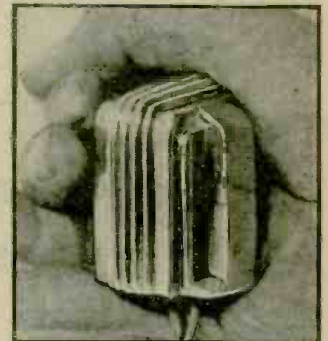

Midget transformer is artistically magnetic-shielded. (1619)

## PUBLIC ADDRESS TUNER KIT (1620)

(Meissner Manufacturing Co.)

HERE is a practical, sensitive P.A. tuner you can build yourself and which will give high-fidelity reproduction of broadcast programs. Frequency range is 530 to 1,600 kc. The T.R.F. circuit uses shielded iron-core R.F. transformers and 4 gang-tuning condensers; also provided are A.V.C., separate output channel for headphone monitoring, manual audio gain, and tone control. Detector output adaptable to any audio (power) amplifier input circuit. Incorporates 3-6K7, 1-6H6, 1-6F8G, and 1-5Z4 tube. Measures  $8\frac{3}{4}$  square x  $12\frac{1}{2}$  ins. deep; this permits 2 units to be mounted in a single relay rack panel. Tuner is self-powered, 110 V., 60 cycles.

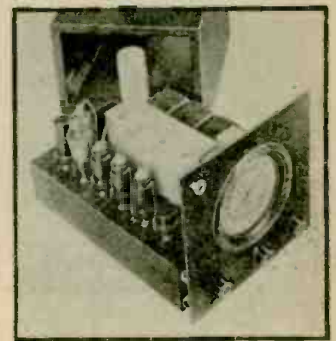

With this kit you can build high-grade radio reception into sound distribution systems for schools, hotels and other public gathering places.

This P.A. tuner kit is priced low. Its frequency range is 530 to 1,600 kc. A T.R.F. circuit is used. (1620)

## NEW 70 TO 100 WATT "TRANSPORTABLE" SYSTEM (1621)

(Wholesale Radio Service Co., Inc.)

THE 70 to 100 W. transportable system, in a new line of coordinated sound equipment suitable for the largest indoor and outdoor installations, is shown. Especially designed for easy removal to and from various installations; the complete system, including amplifier, 2 microphone floor stands, 4 heavy-duty P.M. speakers, all cables, etc., is contained in 3 handsome, airplane luggage styled cases finished in Spanish brown leatherette with contrasting dark-brown striping.



Portable P.A. systems go to higher power. The system shown above is capable of delivering 70 to 100 watts! (1621)

The amplifier occupies its own case and features 4 beam-power tubes, A.V.C. and automatic volume expansion, cathode-ray "eye" output indicator, complete mixing and fading facilities for 4 input channels (including 2 high-gain and 2 low-gain), "neo-dial" controls, variable tone control. A total of 14 tubes is used in the 5-stage circuit.

## RADIO CABINET TOUCH-UP KIT (1622)

NEWEST in cabinet touch-up kits for use by dealers and Service Men is the "right swanky" unit here illustrated. Kit contains quantities of the various cabinet refinishing items used on all types of cabinets as well as all kinds of lacquer finishes in general. The kit is furnished complete in an attractive leatherette carrying-case. The dimensions are  $6\frac{1}{4} \times 12\frac{1}{4} \times 11\text{-}5\text{-}16$  ins. long. Complete instructions for use of the 22 different items in the kit as well as repair procedures for various types of cabinet-finish troubles are supplied.



Radio cabinet touch-up kits show increasing usefulness. The one shown above contains 22 different items the Service Man needs.

Name and address of any manufacturer will be sent on receipt of self-addressed, stamped envelope. Kindly give (number) in above description of device.

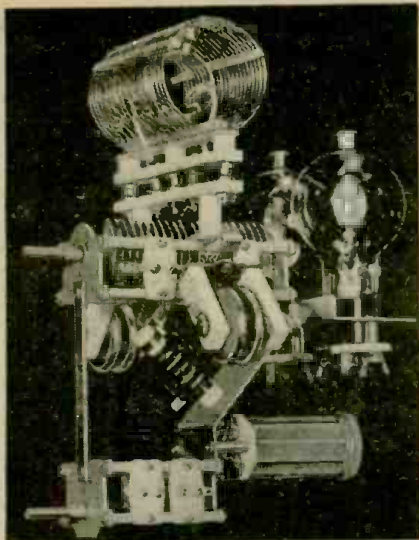

Unit construction idea simplifies building amateur transmitters; reduces possibilities for error. (1623)

### NEW UNIT CONSTRUCTION IDEA IN AMATEUR RADIO TRANSMITTERS (1623)

(The Hammarlund Manufacturing Co., Inc.)

**M**ECHANICAL arrangement of amateur transmitters has always presented quite a problem, since not all amateurs have available the equipment necessary to make the variously-shaped pieces of metal required for modern-type construction. Too, many amateurs are not mechanically inclined. The unit, here illustrated, a push-pull R.F. power amplifier designed to use any of the popular triode tubes having ratings of from 100 to 300 W. output per pair, is the modern and effective solution to these problems.

All parts associated with the amplifier proper, are joined together with brackets of various shapes. This hardware is available in kit form and the only tools necessary for assembling and wiring are a screwdriver and soldering iron. When finished, it is a self-supporting unit which can be bolted to a panel with the mounting screws furnished with the variable condenser; no chassis is necessary.

Although RCA 808s are shown in the photo any of the popular triodes may be used depending upon the desired power output. A circuit of the completed unit is reproduced, on pg. 48, in order to better visualize the relation of the components. All-over dimensions are 13 x 8½ x 8 ins. deep.

### WAFER-THIN CRYSTAL MICROPHONE (1624)

(American Microphone Co., Inc.)

**T**HE NEW B-9 crystal microphone here shown edge-on is a small, lightweight, crystal microphone, with good response and high output. It is

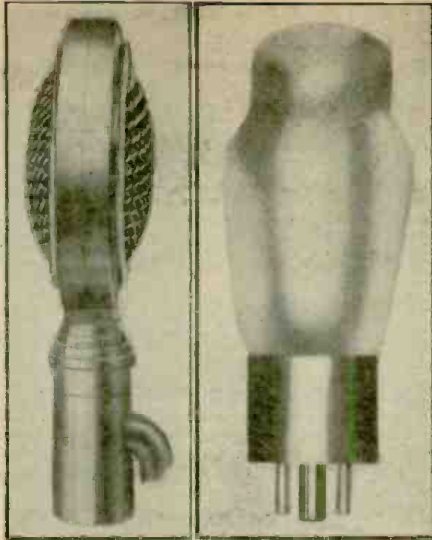

Wafer-thin crystal improved ballast resistor-mike. (1624)

semi-directional and notably free from feedback. This unit has a wide range of applications, enhanced by the available accessories. The B9 is singular in that it is equipped with a plug at the microphone, thus making cable replacement a simple operation. Chrome finish. Complete with plug and 8-ft. cable. Standard 5/8-27 fitting. This unit features an extended useful range in which the bass is efficiently reproduced, an unusual feature in diaphragm-type crystal microphones.

### NEW REGULATORS SAVE PILOT LIGHTS (1625)

(Amperite Company)

**R**ADIO SETS in the new "H" series of A.C.-D.C. replacements, illustrated, are equipped with a patented starting resistor which prevents overloading of pilot lights when the set is first turned on. Service Men should be able to go to town on this item. At the present time there are said to be over 300 A.C.-D.C. ballast replacements, and of course any method of simplifying these is welcomed by both Service Men and jobbers.

These type KL-25A units will replace all ballasts, in one make, starting with K, L, M or BK and having numbers between 11 and 26, and ending in F, G or H. In other words it will replace a K-26F, L-18G, etc. Similarly KL-75H will replace all ballasts starting with K, L, M or BK with numbers 67 to 105 and ending in F, G, or H. For example it will replace K-75H, L-100G, etc. Because the regulator is a real ballast, it can take care of a wide variation in the number of tubes used in a set. It also keeps the tube filaments at ±5% with line voltages from 100 to 140 V.

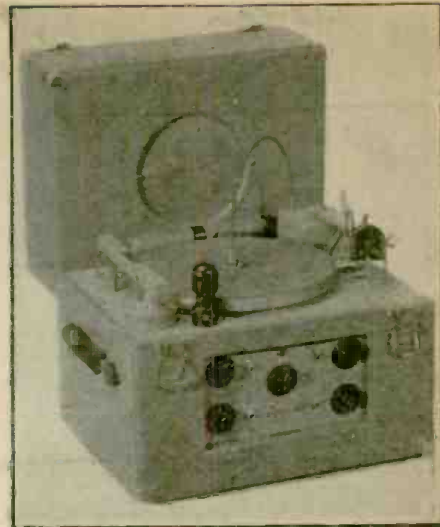

Highly efficient portable recorder and playback unit permits immediate checking of recordings. (1626)

### PORTABLE SOUND RECORDER (1626)

(Sound Apparatus Co.)

**R**ECORDING on the versatile unit here illustrated, is extremely simple; and presents no problems even to persons without technical knowledge or inclination. The record is placed on the turntable, the clamping screw at the end of the flexible shaft is screwed down. After turntable is brought in motion recording arm is moved to the edge of the turntable and recording head is placed on disc. Reproduction of the recorded disc is immediately possible.

Instrument includes a control panel with mixers, master gain control, recording and reproducing switches, monitoring jack, speaker jack, door control and equalizer; a recording chassis with motor, recording lamp (to eliminate turntable and cutter), provision for continuous recording, record-cutting mechanism and reproducer; an 8-in. dynamic loudspeaker; crystal microphone; and 10-W. class A amplifier.

This machine is built in an attractive leatherette case of 13 x 14¼ x 15½ ins. and it is equipped with locks and handles. Complete machine weighs 80 lbs. Operates on 115 V., A.C.

### NEW LINE OF MUTUAL CONDUCTANCE TUBE TESTERS (1627)

**A** WELL-known instrument manufacturer announces a new series of (patented) dynamic mutual conductance tube testers with new square meters having translucent, illuminated meter dials. (The counter-type or model T-53-C is shown; a type T-53-P portable unit is also available.) Said to be the only dual-reading units  
(Continued on following page)

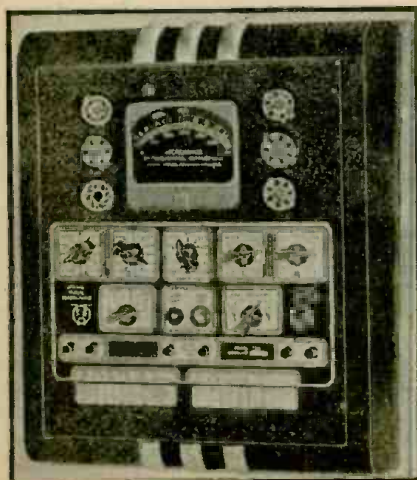

Newest in mutual conductance tube testers. (1627)



New, combined automobile and radio control unit. An achievement in molded plastics. (1628)

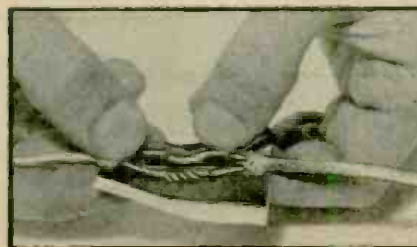

New "splicer"—colored insulating tape—eliminates unsightliness of old-style methods. (1629)

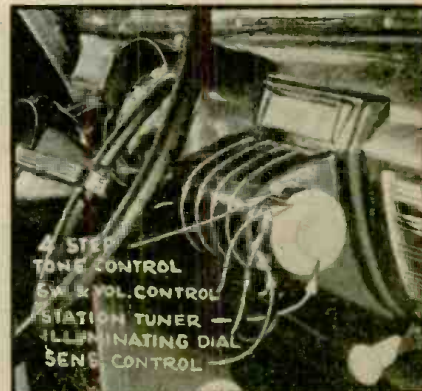

This achievement of the molding art marks a new step in the increasing importance of molded plastics and of the liaison between automobile manufacturers and radio set makers. The car-radio set is becoming an increasingly important, integral part of modern automobile design. The complete unit is shown in close-up at upper-left. (1628)

# THE LATEST RADIO EQUIPMENT

(Continued from preceding page)

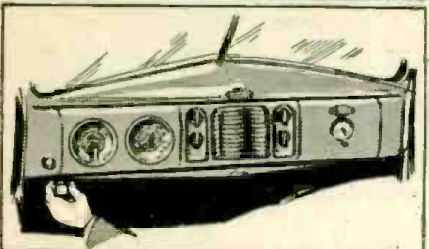
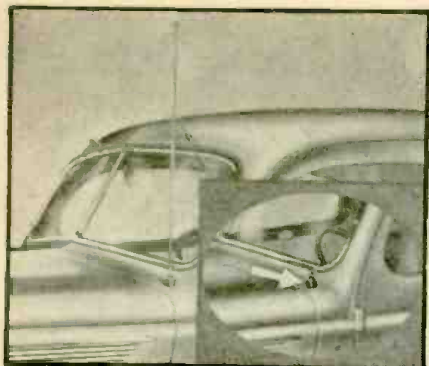

Zip!, and this new car aerial extends to a height of 44 ins.; zip!, and it retracts to nearly cowl-height (arrow, insert). Note control knob below car's instrument panel (see drawing, above). (1630)



Apartment house installations employ 1 "multicoupler" for each radio set. (1631)



An improved gang switch. (1632)



Bakelite-enclosed power resistor. (1633)

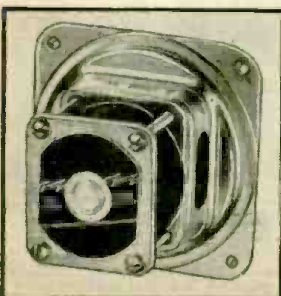

(1634)

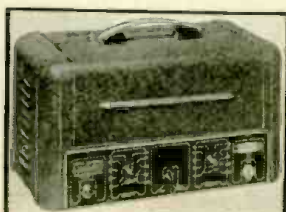

Above—this 14-W. portable P.A. system utilizes inverse feedback. (1635)

Left—Here illustrated is a P.M. dynamic unit in a new line of, and two 3/2-in. dynamic speakers.



This kit can patch wood, plastic and bakelite radio cabinets, and white refrigerators. (1636)

of different characteristics, is used at the antenna-end of the lead-in).

For buildings 15 to 25 stories high, one antenna may be used for operating 15 to 25 radio sets. For buildings 10 stories or less in height, two downleads may be connected to one antenna, to serve up to 20 outlets. The sale of even a single apartment-house antenna system to feed, say, 20 outlets (each outlet terminating in its individual Multicoupler), is indeed a profitable bit of business. Note that the new Multicoupler unit may be recommended for use where improved performance is desired on any wavelength covered by the designation "all-wave."

## SAFETY INSTRUMENT UNIT INCORPORATES RADIO CONTROLS (1628)

NEWEST in automobile plastic moldings is the so-called "safety unit" here illustrated. The right-hand end of this molding incorporates radio controls as illustrated. To make the molded shell of this new control unit a "cannon" exerts 790,000 lbs. pressure at 350 deg. F.

## AT LAST! THE SPLICE GOES MODERN (1629)

KNOWN as a "splice" the modernistic wire splice insulation here illustrated has come to ease the way of the technician who strives to do a neat wiring job. Adhesive tape seldom presents anything but an unsightly appearance whereas the new splices or individual pieces of colored insulating adhesive, afford not only electrical protection sufficient for Underwriters' requirements but also permit matching the appearance of the main conductor (power cord from wall outlet to radio set, etc.).

## BUILT-IN RADIO ANTENNA AUTOMATICALLY RISES AND LOWERS (1630)

WHAT is claimed to be a distinctly new departure in automotive radio aerials is a "Col-Mar" Operative Aerial here illustrated. The use of the word "operative" in the name of the aerial indicates that the aerial is operated as needed, being out of sight when not in use. A touch on the instrument-panel button causes the aerial to rise or to recede into its case (the operation is controlled by the vacuum created at the car's intake). It may be stopped at any desired position.

A feature of unusual interest is the very low-loss short lead-in wire, being only 16 ins. long, the advantage of which is readily understood by those familiar with auto-radio reception. The 1/4-in. tube is made of non-corrosive brass alloy, topped by a bronze knob, triple-plated with copper, nickel and chromium; the final chrome plating being tested under 58-hour salt-spray test. Antenna extends above car to a length of 44 ins., in one model, and 39 ins., in a second; capacity (including lead-in) is approx. 55 mmf. in both types.

## IMPROVED ALL-WAVE "MULTICOUPLER" (1631)

(Amy, Aceves & King, Inc.)

RADIO SERVICE MEN are finding added income in the sale and installation of modern, noise-free antenna systems; a vitally important element of such systems is the "coupler" unit which serves to match the antenna lead-in to the radio receiver. Newest of these couplers is the "Multicoupler" shown here (a second unit,

## IMPROVED GANG SWITCHES (1632)

(Centralab)

A COMPLETE line of selector switches assembled with an isolantite insulation has just been announced. The group designed for the radio amateur operates safely at potentials up to 1,000 V., D.C. and up to 100 W. The second group, of interest to design engineers, is available in all the usual multiple position types.

## CENTER-TAPPED WIRE-WOUND RESISTORS (1633)

(International Resistance Co.)

A LINE of new center-tapped wire-wound resistors is available in values between 10 and 200 ohms. Carrying capacity is up to 5 W. chassis-wound and 2 1/2 W. open-air mounted. Resistor is enclosed in molded bakelite.

## TWO NEW 3 1/2-INCH LOUD-SPEAKERS (1634)

(Utah Radio Products Co.)

TWO NEW 3 1/2-in. speakers have been announced by a well-known manufacturer. One unit is a permanent-magnet dynamic (illustrated), and the other is an electrodynamic type. The manufacturer claims "vast improvement" in the performance of these small speakers, one improvement being the proportioning of the generated harmonics in the cone surface to enable these small speakers to produce exceptional tone quality.

The announced specifications of the electrodynamic unit are as follows: field coil, 450 ohms; voice coil, 3 1/2 ohms; output, 5 W.; frequency range, 200 to 8,000 cycles. The permanent-magnet of the P.M. unit is designed to give a flux density in the air gap that gives this speaker practically the same performance as the electrodynamic with a saving of from 3 to 6 W. current consumption.

## 14-WATT PORTABLE SOUND SYSTEM (1635)

(The Webster Company, Chicago)

JUST announced, is a new 14-W. portable sound system, using an inverse-feedback circuit. It is claimed that within its rated output, distortion has been kept within 2 per cent.

This model features a full-length microphone stand with screw-type microphone connections, tone control and 2 permanent-magnet speakers, all stowed in a single leatherette-covered carrying case. This model PA-714 amplifier is said to have been tested and approved by the Underwriters' Laboratories.

(Continued on page 48)



Special products for technicians. (1637)

Service Men may write, requesting answers to specific service questions. Address inquiries to Service Editor. For questions answered by mail, a service fee of 25c per question is made. Only questions of wide interest can be published. In view of the "rush" character of most service calls an effort is made to maintain 48-hour service on mail inquiries. Let us help you solve your service problems.

# SERVICING QUESTIONS & ANSWERS

## RECORD PLAYER CONNECTION

(59) Earl Vance, Lebanon, Ky.

(Q.) We have sold an R93A Victor record player for a Philco model 37-116 receiver and want to know how to make the hookup for best tone and volume. Please state best method of reducing needle scratch.

(A.) For best results, connect the RCA record player into the volume-control circuit of the Philco model 37-116 receiver as shown in Fig. Q.59. The double-pole double-throw switch may be either the toggle or knife type, and is employed to change from radio to phono operation. The lead to the "high" side of the radio volume control is removed and brought out to the switch, as is a lead from the "high" side of the control. Shielded leads, with shield grounded, are used for this purpose. Leads should be as short as

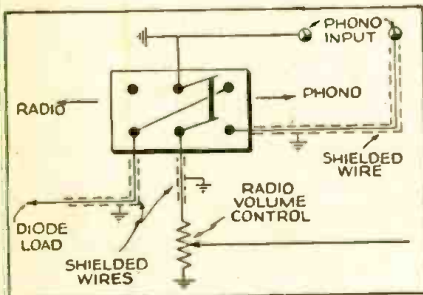

Fig. Q.59

possible. With the switch in the phono position, the diode load or radio input is grounded, thus preventing the possibility of radio interference.

In this manner, the receiver volume control with bass compensation network and tone control may be used during phono operation. Needle scratch may be reduced by manipulating the tone control.

Where it is found that insufficient output is obtained by connecting into the volume control circuit, a "phonograph oscillator" is in order. A "phonograph oscillator" is nothing more than an unmodulated R.F. oscillator, tuned to some frequency within the broadcast band, usually at the high-frequency end. The receiver likewise is adjusted to this frequency. The phono pickup modulates the oscillator. These attachments are available, commercially. The phono unit connects to the oscillator input, the output of which goes to antenna and ground of set.

## OSCILLATOR FAILURE

(60) A. W. Larson, Waterville, Me.

(Q.) We have a Zenith model 705 in for repair. The trouble lies with the 56 oscillator which fails to function. Tubes have been tested as have been all resistors and condensers. The condenser block has been replaced. Alignment does not help. A whistle is heard at the same part of dial. What is the remedy?

(A.) From your letter, it is to be assumed that the trouble mentioned with the Zenith 705 receiver has been definitely traced to the oscillator stage.

Failure of the oscillator in this receiver,

ordinarily, has been traced to an open-circuited .01-mf. oscillator plate coupling condenser, C, as shown in Fig. Q.60. Should this condenser prove intact, carry out a resistance analysis of the oscillator stage. Resistance readings from plate, grid and cathode to chassis should be approximately 60,000 ohms, 0.25-meg., and zero ohms, respectively.

## S.-W. IMAGE-FREQUENCY TROUBLE

(61) E. J. Symancyk, Westfield, Mass.

(Q.) I have a Zenith 12-tube receiver, chassis 1202. Within the past few months, I receive the 20 meter stations at 14 mc. and 13 mc. In other words, 20-meter stations are received at 2 points

(Continued on page 48)

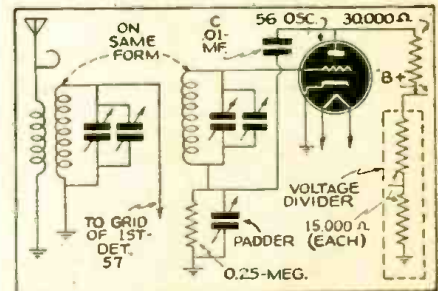

Fig. Q.60

**FREE** — A 1-year subscription to RADIO-CRAFT to each person who submits a WITTIQUIZ that in the opinion of the Editors is suitable for publication in RADIO-CRAFT. Read the following WITTIQUIZZES; can you spot the correct answers? Now send in YOUR idea of one or more good WITTIQUIZZES based on some term used in radio, and win an award. (Contest rules at end of dept.)



(85) A choke is—

(a) A patented device, in expensive radio sets, used to choke undesirable sopranos. (b) A coil of wire used to filter a direct current. (c) A coil of wire used to filter an alternating current. (d) A coil offering a high resistance to an alternating current.

L. BRUCE

(86) Hand capacity is—

(a) The biggest handful of bypass condensers that can be swiped from your neighbor's radio junkbox without being caught. (b) When the capacity between the hand and some component in a detector detunes it. (c) The amount of high voltage that the hand will take without drawing back. (d) The number of radio signals that can be held in the hand without spilling over (breaking into oscillation).

PAUL BAUERLE

(87) Condenser reactance is—

(a) A disease contracted by persons engaged in the manufacture of condensers. (b) A regeneration effect obtained by the use of a condenser in a radio circuit. (c) A measure of the opposition offered to the flow of A.C. (d) A heating effect which occurs when a condenser is short-circuited.

J. A. GIBBONS  
Wallasey, England.

(88) A radio speaker is—

(a) A person that gives radio instructions. (b) Anyone who talks over "the radio." (c) A person that's always talking about radio receivers. (d) A device which converts electrical impulses into audible sound. (e) A member of Congress with a knowledge of radio.

PAUL FIZETTE

(89) A quartz crystal is—

(a) The ice formed by freezing one or more quarts of water. (b) A recently-invented device for foretelling the future by radio-activity. (c) An oscillating crystal used in stabilizing the frequency of a transmitter. (d) An obsolete tubeless receiving device used in the early days of radio.

FRANK H. TOOKER

(90) Every Service Man knows that a sound-head is—

(a) A bald-headed man who owns a costly radio set. (b) A headphone used by a sound technician in a studio. (c) A sound engineer. (d) An apparatus attached just below a projector for the reproduction of the recorded sound on the film. (e) A vaudeictorian in a correspondence radio school.

JESUS CHICO,  
Manila, P.I.

(91) Service Men should know that a ballast is—

(a) A line voltage regulator. (b) The extra weight placed in a ship's hold to maintain stability. (c) A device used to steady the receiver chassis, preventing vibration.

(92) And that a potentiometer is—

(a) A meter used in testing for different potentials. (b) An instrument used by chemists to determine the potency of certain drugs. (c) A variable resistor, having 3 terminals, and used as a voltage divider, or volume control.

J. VANHUYSE  
Windsor, Ont., Can.

(93) The emission of a tube consists of—

(a) The stream of electrons emerging from the cathode. (b) The elimination of static discharges which are shunted through a condenser to ground. (c) The incoming signal entering the grid.

MILTON SCHRAG

(94) Do you believe that a commutator is—

(a) A news-flash announcer? (b) A system of collector rings on an A.C. generator? (c) A ring of segments which contact the brushes on a D.C. generator to make the current flow in one direction? (d) A band-switch?

HAROLD FOX

(95) A plug must be—

(a) Used for stopping the grid-leak. (b) An

(Continued on page 56)

MOTOROLA MODEL 8-80 (GOLDEN VOICE) CAR-RADIO SET

8-tube Superhet.; pushbutton tuning; spot tuning; "Acoustinator" control; A.V.C.; Output (max.) 13W.; Battery drain 8.5 amps. (See Data Sheet No. 230 for additional information)

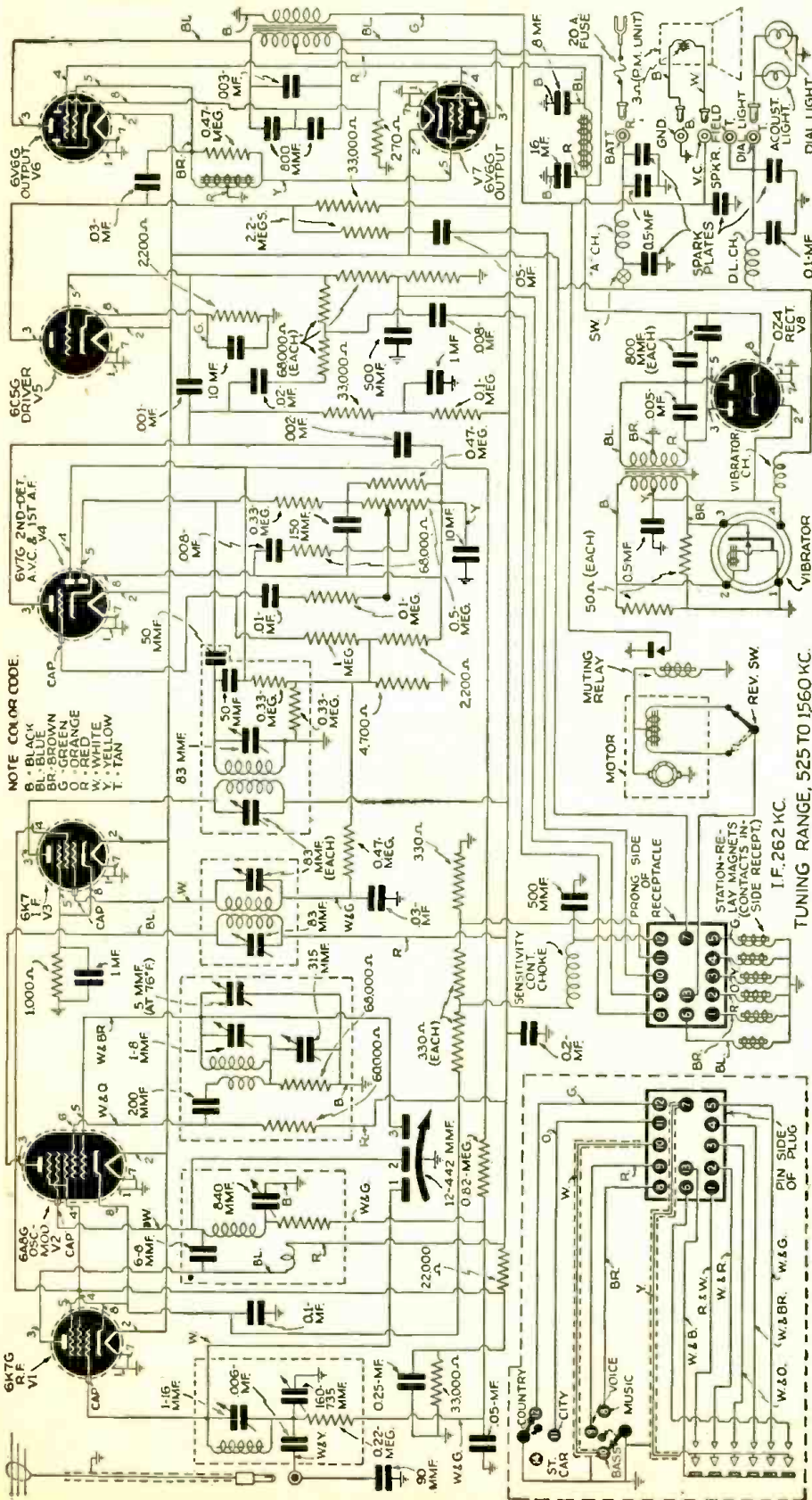

Fig. 5. Schematic diagram of the 8-tube superhet. Motorola automobile receiver.

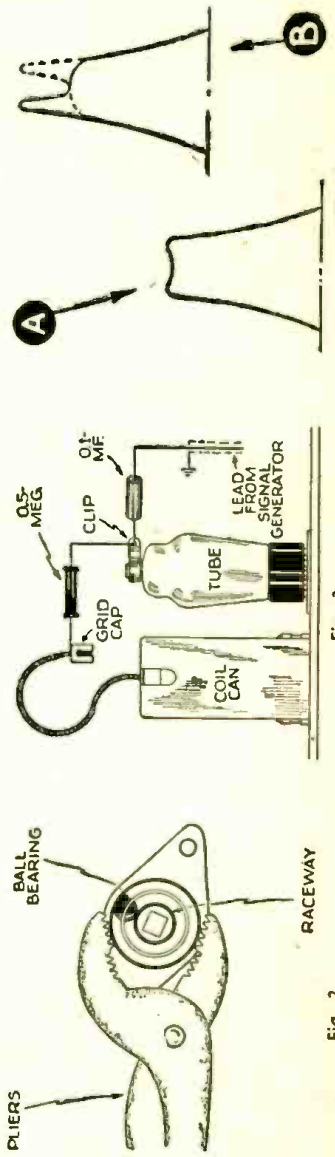

Fig. 4

Fig. 3

Fig. 2

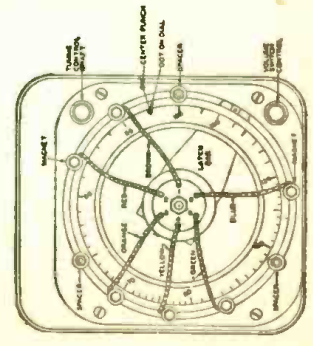

Fig. 1

## MOTOROLA MODEL 8-80 (GOLDEN VOICE) CAR-RADIO SET

8-tube Superhet.; pushbutton tuning; spot tuning; "Acoustinator" control; A.V.C.; Output (max.) 13W.; Battery drain 8.5 amps.  
(See Data Sheet No. 229 for schematic and other diagrams.)

### Push-Button Tuner Adjustment

To set the stations, proceed as follows: (1.) Turn the set on and let it play for **NOT LESS THAN 10 MINUTES**, to assure all electrical circuits reaching a constant operating temperature. (2.) Select 6 stations to be "set" and arrange the 6 magnets to the approximate station frequencies as indicated on the scale, locking them in position. **DO NOT "SET" WEAK STATIONS.** (Fig. 1.) (3.) Press the first button. The motor will bring the mechanism to the first magnet. Loosen the lock nut. (4.) Tune manually to the exact peak of the station, using the tuning knob in the control head. (5.) Press the first button half-way in (far enough to energize the magnet, but not far enough to start the motor or mute the set.) (6.) Slide the magnet in the direction of error until a "click" indicates that the latch bar has engaged in the stop. (7.) Tighten the lock nut. (8.) Proceed to "set" the other 5 stations.

### Spot Tuner Adjustment

(1.) Slip the spot tuner housing up the flexible control shaft far enough to expose the spot tuner mechanism, which consists of a small ball bearing, a brass raceway in which it moves, and a slotted retainer clip which acts as its guide. (2.) Tune in the desired station as accurately as possible. A tuning meter is recommended, except for Model 8-40, which has no Acoustinator receptacle. (3.) With a pair of slip jaw pliers, one jaw of which rests firmly on the small ball bearing, the other jaw of which rests on the bottom of the unit, apply enough pressure on the ball to force an indentation in the brass raceway in which it moves. (Fig. 2.) Proceed to set other favorite stations in the same manner. The raceway has a double track. Therefore, should you desire to reset the SPOT TUNER to a new series of stations, it can be done by moving the ball bearing over to the second track. To do this, turn the condenser gang to full mesh (ball bearing at extreme end of raceway) and with a pointed instrument, force the ball bearing into the adjoining groove. **A THIRD SETTING CAN BE MADE ONLY BY INSTALLING A NEW RACEWAY.** Order part No. 1X4487.

### Alignment Procedure

Plug in the Acoustinator, if the set undergoing alignment is thus equipped. Set Acoustinator at "Country" and "Voice" positions. Connect the speaker to the chassis and plug the "A" lead into its receptacle. Turn the volume control to maximum and leave it in that position throughout the alignment, reducing the signal generator output if necessary.

#### IMPORTANT NOTE:

The trimmer labeled 600 kc. in the R.F. coil can must not be adjusted in the field. It is the key point in the entire R.F. alignment and was carefully set in the factory by means of an accurate capacity bridge to its correct capacity (840 mmf.). Before shipment, this trimmer was covered by a strip of black Scotch Tape, which should be left in position to eliminate any possibility of shifting its capacity through error.

#### I.F. ALIGNMENT

(1.) Connect signal generator to control grid of the Osc.-Mod. tube (6A7 or 6AG) through a 0.1-mf. condenser, having first removed the grid cap from the top of the tube. (See Fig. 3.) Connect a 500,000 ohm resistor from the Grid of the tube to the grid cap on the lead just removed from this tube. Turn condenser gang completely out of mesh. Connect output meter across speaker voice coil. (2.) Set signal generator at 262 kc. and carefully adjust the trimmers in the diode coil can to the point showing

highest reading on the output meter. (3.) Adjust the trimmers in the I.F. coil can to the point showing highest reading on the output meter. (4.) Go over I.F. and diode adjustment several times to secure maximum accuracy.

#### SETTING THE RANGE

(1.) Connect signal generator to the control grid of the R.F. tube (78 or 6K7G) through a 0.1-mf. condenser, having first removed the grip cap from the top of the tube. Connect a 0.5-meg. resistor from the grid of the tube to the grid cap on the lead just removed from this tube. (See Fig. 3.) (2.) Set signal generator at 1,560 kc. and, with condenser gang completely out of mesh, adjust for maximum deflection on the output meter, the trimmer in the oscillator coil can labeled 1,400 kc. (3.) Set signal generator at 535 kc. Turn condenser plates completely in mesh and adjust for maximum deflection on output meter, the trimmer in the oscillator coil can marked 600 kc.

**NOTE:** The adjustments above set the range so the receiver will track with the calibrations in the control head.

#### R.F. AND ANTENNA ALIGNMENT

(1.) Connect the signal generator to the antenna lead through a 0.00015-mf. condenser and to chassis ground. Set signal generator at 600 kc. and turn condenser gang until signal is heard. Adjust trimmer on the antenna coil can labeled 600 kc. for maximum deflection of output meter. (2.) Set signal generator at 1,400 kc. Turn condenser gang until signal is heard. Adjust for maximum deflection of output meter, the trimmer in the antenna coil can marked 1,400 kc. (3.) Adjust for maximum deflection of output meter, the trimmer in the R.F. coil can marked 1,400 kc. (4.) Recheck steps 1, 2, and 3, for accuracy.

#### Use of Oscilloscope in Aligning I.F.'s

**EQUIPMENT REQUIRED:** Cathode-ray oscilloscope and a frequency-modulated signal generator. (NOTE: if your signal generator is unmodulated, a frequency modulator will be required to adapt it for use with the oscilloscope.)

#### PROCEDURE:

(1.) Align I.F. and diode trimmers in the regular manner as outlined in preceding paragraphs. (2.) Connect "wobbulator" to control-grid of Osc.-Mod. tube (6A7 or 6AG) through a 0.1-mf. condenser, having first removed the grid cap from the top of the tube. Connect a 0.5-meg. resistor from the grid of the tube to the grid cap on the lead just removed from this tube. (Fig. 3.) (3.) Connect oscilloscope to the top or high side of the diode load resistor, which, in this case, is the volume control. (4.) Adjust the "wobbulator" frequency to 262 kc. and observe the picture of the I.F. resonance curve as shown on the oscilloscope "screen." Correct alignment will result in a flat top curve, as shown in Fig. 4A. (5.) Should the curve appear sharp at the "nose" with a shelf on either side of the peak, as shown in Fig. 4B, adjust the PLATE trimmer of the I.F. transformer slightly, until the curve approaches the condition shown in Fig. 4A. If the regular I.F. alignment has been properly carried out, it will be necessary only in rare instances to adjust other than the I.F. PLATE trimmer.

#### \*OPERATING VOLTAGES

	2	3	4	5	6	7	8
V1	0	255	90	0	X	6.0	4.0
V2	6.0	255	90	9.4	120	0	4.0
V3	0	255	90	4.4	X	6.0	4.4
V4	0	50	0	.2	X	6.0	7.0
V5	0	150	X	0	X	6.0	5.6
V6	0	255	255	0	X	6.0	15.0
X8	0	300 A.C.	X	300 A.C.	X	6.0	260

"X" indicates socket terminals used as dummy tie points.



(Acoustinator, lower-left, is not mounted on set.)

All readings except rect. plates are from chassis ground to socket terminal indicated. Measurements made with 1,000 ohms/volt meter. Voltage at Battery—6.3 V. Voltage at Receiver—6.0 V.

Current Consumption—8.5 amps.—Output (max.) 13 W.

\*Note: The numerals heading the columns refer to socket terminals (see schematic diagram, Fig. 5).

#### Automatic Service Notes

##### MOTOR FAILS TO START

(1.) **MOTOR CONTACTS IN ACOUSTINATOR NOT CLOSING.** Open the Acoustinator and inspect the motor contacts. If the gap is too great, contact will not be made when the button is pressed. Adjust by bending carefully.

(2.) **POOR CONTACT AT ACOUSTINATOR PLUG.** Inspect the contacts between the Acoustinator plug and the receptacle on the chassis.

(3.) **DEFECTIVE REVERSING SWITCH.** A defective switch would prevent the voltage from reaching the motor winding.

(4.) **OPEN-CIRCUIT IN MOTOR.** Check all connections to motor and check motor winding for continuity.

(5.) **MOTOR BRUSHES NOT MAKING CONTACT.** Check contact between brushes and commutator.

(6.) **LOW BATTERY VOLTAGE.** A weak or defective battery in the car would not deliver sufficient voltage to start the motor.

(7.) **FLEXIBLE TUNING SHAFT BINDS.** Binding in the flexible tuning shaft places an additional load on the motor. If this load is too great, it will prevent the motor from turning the mechanism.

(8.) **MAGNET FAILS TO RELEASE.** If the magnet which has previously been energized, fails to release the latch bar for any reason, the motor cannot turn the mechanism.

##### FAILS TO STOP AT MAGNET

(1.) **OPEN MAGNET WINDING.** Check for continuity and replace if necessary.

(2.) **MAGNET CONTACT IN ACOUSTINATOR NOT CLOSING.** Open Acoustinator and inspect contacts. Adjust or clean if necessary.

(3.) **ROUNDED HEAD ON MAGNET CORE.** The head of the magnet should have sharp corners. Rounded corners may cause the latch bar to slip going in one direction, although it will usually catch in the reverse direction.

(4.) **LATCH BAR DEFECTIVE.** Inspect latch bar to make sure that it has not been damaged. Replace latch bar and gear assembly, if required.

(5.) **POOR CONTACT AT ACOUSTINATOR PLUG.** A poor contact here means a voltage drop which reduces the pulling power of the magnet.

(6.) **IMPROPER SPACING OF LATCH BAR.** Check the spacing between the latch bar and the magnet. It should be somewhere between 0.01- and 0.02-inch. If the spacing is greater the pulling power of the magnet is reduced.

# A WIRED-RADIO "NURSEMAID"

(Continued from page 31)

circuit by means of a low impedance coupling coil. A harmonic filter is built into the Guardian Ear to prevent radio receiver interference at 600, 900 and 1,200 kc.

Bias on both grids of the 79 tube is obtained by the use of bias cells. These units have an extremely long life and should not be replaced unless the plate voltages of the 79 tube measure abnormally low. Never test the bias cell with a voltmeter of any kind. The current drawn by the meter will discharge the cell immediately, and no reading will be obtained although the cell may be in good condition. Only a vacuum-tube voltmeter will show the true condition of the bias cells.

The receiver is coupled from the line to a 6F5G detector by another low impedance link. The detector is capacity-coupled to a 41 output tube.

When shipped from the factory, both units are adjusted accurately to 300 kc. by means of a variable trimmer in each unit. If for any reason it is suspected that either of the units is not tuned to resonance, it is only necessary to readjust the trimmer on the side of the Guardian Ear, until maximum sensitivity is reached. Maximum sensitivity may be found by placing a watch on the Guardian Ear, and after raising the volume on the Radio Nurse to a point just below feedback (howl), adjust the Guardian Ear trimmer for maximum volume of the watch tick.

The trimmers have a tuning range of from 250 to 450 kc. If interference from another Radio Nurse is encountered, it may be eliminated by readjusting either pair of units in the following manner. Shift the frequency of one Radio Nurse (Bakelite unit) slightly or until the interference drops out. The bakelite shell of the Nurse must be removed in order to reach the trimmer. The Guardian Ear of the pair is then tuned to resonance as previously outlined.

## 3-WIRE SYSTEMS

In cases where the electric service to the home or apartment is of the 3-wire, 220-volt type, and the transmitter is used on one 110-volt circuit and the receiver on the other, it is sometimes necessary to install a bridging condenser across the outside 220-volt leads to form a path for the signals. To accomplish this, a special bridging condenser was developed. This condenser is a special oil-impregnated unit made for continuous operation on 250 volts A.C. and has a 2.5 ampere fuse sealed inside the condenser case.

The condenser is connected to the line by first removing a fuse on one side of the 220-volt circuit and inserting the metal tab into the shell of the fuse socket so that when the fuse is screwed back into place the metal strip makes contact with the shell of the fuse. The remain-

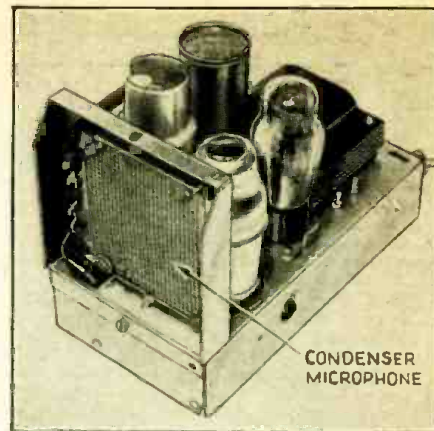

Fig. A. The "Guardian Ear" or pick-up unit.

ing condenser wire is fastened under a fuse on the opposite side of the 220-volt circuit in the same manner.

In some installations, fuses are used on both the live side of the line as well as the neutral or ground circuit. In such cases it is imperative that the two fuses to which the condenser is connected be in the live leads and not in the ground side.

(Continued on page 53)

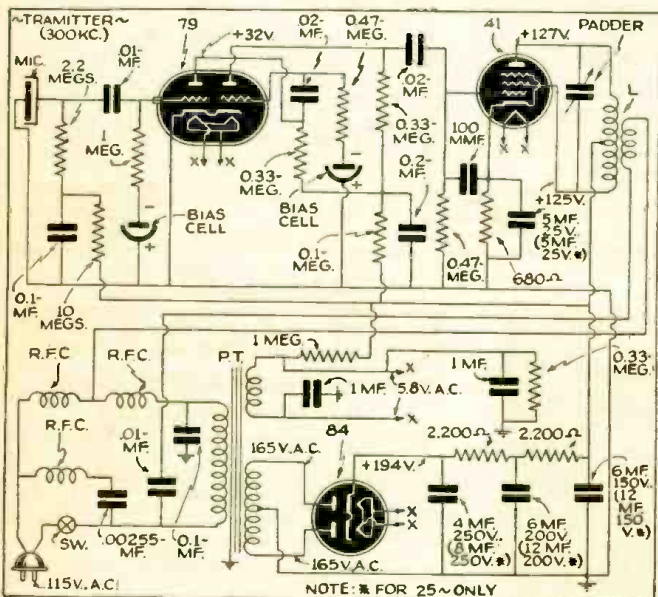

Fig. 1. Schematic circuit of the "Guardian Ear" or pick-up unit shown in Fig. A.

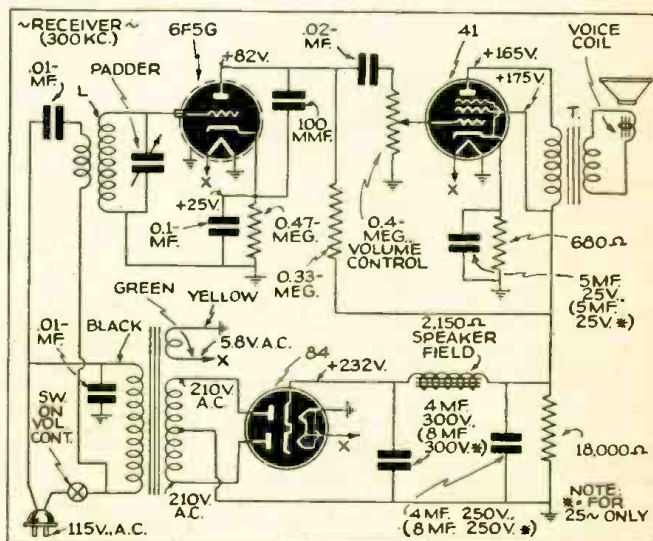

Fig. 2. Diagram of the "Radio Nurse" or reproducing unit shown in Fig. B, on pg. 53. The volume control knob which extends out of the bottom of the bakelite shell of the Nurse is adjusted until the tick of a watch laid on top of the remote "ear" can be heard loudly. The electric light wiring automatically supplies the required "connection" between the 2 units.

## MODIFYING OLDER SETS TO RECEIVE THE 4 HIGH-FIDELITY STATIONS

(Continued from page 21)

(See Fig. 1B.) This will cause a more serious error in the dial readings than the adjustment of the trimmer condensers. However, if the dial is calibrated in arbitrary numbers such as 0 to 100, the Service Man can leave a list of the new dial readings so that the set owner can memorize them. Do not take out plates of a condenser to reduce the minimum capacity as it will also reduce the maximum amount of capacity and will probably reduce the tuning range of the receiver instead of increasing it. In this case the maximum error would then be at the low-frequency end of the dial.

In adjusting the trimmer condenser of a superheterodyne receiver, the oscillator trimmer will be the most critical, the mixer and radio-frequency stages being comparatively broad. The padding condenser can then be readjusted for proper tracking. If correctly done, the original dial settings will not be changed appreciably. If the superheterodyne is not equipped with a padding condenser, but depends upon an especially-built oscillator condenser, there will be a slight tracking error, but it will not be serious.

## SHIFTING THE I.F.

Another way to tackle a superheterodyne is by shifting the intermediate frequency. (See Fig. 1C.) Sometimes this will work, but will cause a tracking error that may or may not be permissible.

As a general rule, the high-frequency end of a receiver is the noisiest. It is VERY IMPORTANT then to get the highest signal-to-noise ratio possible for quiet reception; especially is this true where higher-fidelity programs are to be received. Many sets operate satisfactorily without an antenna, or with a poor one on the high-powered, lower-frequency stations, but unsatisfactorily on the higher-frequency stations. Make every effort to get up a good outdoor antenna for best reception. If a good ground is not obtainable, sometimes better reception will be had by not using one at all. (See, also, "The Problems in High-Fidelity Design," in December, '34 Radio-Craft, for additional information on what to do to the set, once high-fidelity programs can be tuned-in, to get the most from the receiver.—Editor)

## RADIO CREATES AMAZING FASHION PATTERNS

(Continued from page 11)

designs which would drive a surrealist artist more frantic with envy. But space limitations do not permit us to reproduce them.

One of the more complicated designs so favorably impressed the designer of machine-made tapestry that he drew up a sketch of window curtains using the pattern. A lace factory is also interested in it, with the idea of producing curtains. Thus not only novelty manufacturers find new avenues of expression opened up, but also the producers of more bulky items, as for instance these curtains, and floor-coverings, etc., now have at their command a machine that is capable of producing patterns in inexhaustible variety.

Infinite in number and variety are the patterns produced by this new RCA cathode-ray kaleidoscope, and plans are already under way to inaugurate an "electronic pattern" service to the leading dress, textile, plastic, wrapper and jewelry designers of Paris and America.

This invasion of the field of art by electronics adds a milestone to radio.



## EUROPE'S UNDECLARED RADIO WAR!

(Continued from page 9)

that it became very difficult, almost impossible, to hear this station. But it still broadcasts, and is now to be heard on a wavelength of 23.8 meters. It remains a real mystery.

The Spanish trouble has added greatly to the war on the air. First of all, Moscow transmitted more Spanish talks than formerly, saying to the Republicans, "We are with you with all our soul." Then General Franco captured several broadcasting stations sharing wavelengths with those still in government hands.

Bilbao and San Sebastian used to vie with one another, until the capture of Bilbao when from the broadcasting station could be heard the entry of the troops. Then General Franco increased the power of the Salamanca station to unknown kilowatts and transmitted on the same wavelength as Madrid.

Another feature of the struggle has been the entirely illegal use of the amateur wavelengths on the 40-meter band for news and propaganda. And within the last few months, one or two stations have begun transmitting on the 20-meter band. Both sides do this. They give propaganda in at least 4 languages, and both try to jam each other. In addition, it is noticeable that the Spanish government transmissions in German and Italian suffer more from jamming than any others. Presumably, the German and Italian authorities are responsible for this.

A strange happening in the Spanish war has been the transmissions of a station calling itself "Radio Verdad," and broadcasting in Spanish. (*Verdad* is Spanish for *truth*.) As they use several Italian wavelengths on the medium band, I thought that either the Italians were closing down their stations to allow the Spanish station to broadcast its "truth" propaganda, or that the Italians were responsible for the whole thing.

They give an address in Salamanca to which listeners are asked to write. I wrote, but have had no answer. When listening to Rome at 7 o'clock G.M.T., I heard the station sign off, and then the carrier disappear, before Radio Verdad made its transmission. But Radio Verdad's announcer has a slight Catalan accent, which shows that he does not come from Salamanca. This made me suspicious. Then a friend used directional antennas on the transmission, and Radio Verdad was proved to be the Italians masquerading as Spaniards.

This is perhaps not very surprising, since I have seen it stated that broadcasting in General Franco's territory is almost entirely under Italian control. Oddly enough, the only Italian I know had a job with the Italian broadcasting company in Rome, and then he went to Salamanca, General Franco's headquarters.

Italian used to be the only major European language in which the Russians never gave Communist propaganda. I wrote to Moscow and asked them why; but, though they answered my letter, they refused to answer this question. It has been suggested that a clause between the two countries forbade the broadcasting of propaganda. In addition, there was a rumor that Mussolini had so successfully jammed all the Russian stations that they ceased their propaganda in Italian. However, lately, Moscow has been giving propaganda in Italian—just another radio mystery.

The Italian broadcasts from Rome and Bari in Arabic have raised much protest over here in England. But in addition to those in Arabic, there are others in Chinese and other Oriental languages. It is these Arabic transmissions that have compelled the British Broadcasting Corporation to broadcast in Arabic in order that Palestine should have a source of radio news other than that from Italy.

And so the B.B.C. feels compelled to broadcast in foreign languages; it began with Arabic early this year. When I first listened to these broadcasts, I felt certain that there was a definite effort being made to jam them. I could hear the chimes of Big Ben perfectly, but the moment the Arabic announcement was made, it was overwhelmed by interruption. Whether this interruption was successful in preventing reception in the East, is another matter. Last night I listened to the British transmissions in Spanish and Portuguese. The half-hour's news bulletins came in uninterrupted.

(Radio-Craft feels that its readers will be particularly receptive to this article, which contains first-hand information.)

# SUPERIOR PRESENTS

## THE AMAZING, NEW 1938 1100 SERIES

The Best Buy in the Instrument Field! Many New Refinements, New Features. . . All Proven to Be Sound and Practical!

### The New Model 1100-S

## D.C. VOLT-OHM MILLIAMMETER

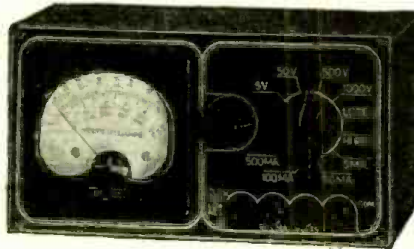

A sensationally low priced new pocket-size volt-ohm milliammeter. Features a 3" d'Arsonval type 0-1 meter, accurate within 2%; precision resistors. No external batteries necessary. Neat aluminum etched panel.

#### SPECIFICATIONS

0-5 volts D.C.	0-5 ma. D.C.
0-50 volts D.C.	0-50 ma. D.C.
0-500 volts D.C.	0-100 ma. D.C.
0-1000 volts D.C.	0-500 ma. D.C.
0-500 ohms	0-500,000 ohms

Model 1100-S supplied with batteries, test leads and instructions. Size 6 1/2" x 3 1/4" x 2 1/2"; shipping weight 4 1/2 lbs. Our net price.....

**\$585**

### The New Model 1120-S

## OSCILLATOR

Truly the greatest value ever offered! An All-Wave, direct-reading Oscillator in Portable size. Compares favorably with instruments selling at three times its price! Housed in a black crystalline cabinet with carrying handle.



#### SPECIFICATIONS:

- Covers 100 kc. to 22 mc.; all on fundamentals, with ranges selected by front panel band switch, and frequencies in those ranges by dial manipulation.
- Dial is direct reading in frequencies, with band switch settings identified both by letters (A, B, C, D, E) and by frequencies, with the corresponding identifications on the dial scale.
- R.F. and A.F. outputs obtainable independently.
- Accuracy 1 per cent on I.F. and broadcast bands, 2 per cent on the short waves.
- Separate posts for testing shorts, opens and leakages, including the leakage of electrolytic and other condensers. Thus even very high resistance circuits may be tested for continuity.
- Planetary turn-easy drive, with 4-1 vernier.
- Operates on 90-120 volts A.C. or D.C. Storage A.C. may be of any commercial frequency, 25, 40, 50, 60 cycles, etc.

Model 1120-S supplied complete with tubes, leads, and instructions. Shipping weight 8 pounds. Size 10" x 7" x 4 1/2". Our net price

**\$885**

### The New Model 1160-S

## SET TESTER

A Complete Laboratory All in One Unit!

Featuring Our New Type Sloping Panel for Precise and Rapid Servicing

Here is a modern set tester that conforms to all standards of good engineering practice. Utilizes a modern, square d'Arsonval type meter and precision resistors. Just what every Serviceman needs for rapid, accurate measurements.

#### SPECIFICATIONS

COMPLETE A.C. and D.C. VOLTAGE and CURRENT RANGES

D.C. Voltage: 0-15, 0-150, 0-750 volts.  
A.C. Voltage: 0-15, 0-150, 0-750 volts.  
D.C. Current: 0-1, 0-15, 0-150, 0-750 ma.  
A.C. Current: 0-15, 0-150, 0-750 ma.

2 RESISTANCE RANGES

0-500 ohms 500-5 megohms  
HIGH and LOW CAPACITY SCALES

.0005 to 1 mfd. and .05 to 200 mfd.

3 DECIBEL RANGES

-10 to +19, -10 to +38, -10 to +53

INDUCTANCE: 1 to 700 Henries

WATTS: Based on 6 mw. at 0 D.B. in 500 ohms .006000 to 600 watts.

- Tests all 4, 5, 6, 7s, 7L, and octal base tubes, including diodes.
- Tests by the well established emission method for tube quality, directly read on the GOOD ? BAD scale of the meter.
- Affords separate neon test for leakage and shorts between elements.
- All services performed by the use of only five controls at maximum, and many tests do not require working all the controls.
- Supplied with instructions and reference table so that the filament voltage and emission measuring controls may be properly set for the enumerated long list of tubes, which includes all tubes commonly encountered in servicing.
- Work on 90-120 volts A.C. 60 cycle A.C.

Comes housed in sturdy, black case with sloping panel. Complete with test leads, tabular charts, instructions and tabular data for every known receiving type tube, including many transmitting types. SIZE: 11 1/4" x 9 1/4" x 5". Shipping wght. 13 lbs. Our net price

**\$1785**

Model 1160 A-S with Portable Cover, add 95c

# SUPERIOR INSTRUMENT CO.

136 LIBERTY ST. Dept. RC-738 NEW YORK, N. Y.

# The Ideal radio service car

FAST—Dependable—Convenient—Economical



The last word in light, economical service equipment. Comes with large, commodious side car. Gives 120 miles on a gallon of gasoline, ends parking worries, garage and upkeep expense. Draws a crowd at every stop—it's the best advertising you can buy.

Write for catalog



**MOTO-SCOOT MFG. CO.**  
237 S. Western Ave., Chicago, U.S.A.

## USEFUL CIRCUIT IDEAS

(Continued from page 30)

case is made with the 0.4-meg. variable resistor. Exact setting of the 0.4-meg. resistor can be found by comparing with a known accurate voltmeter. Jacks 1 and 3 are for continuity and ohmmeter with 0.4-meg. resistor as zero adjuster for latter. The ohmmeter may be calibrated with known values as tested with another ohmmeter known to be correct. A 45 V. battery may be used externally with "+" at jack 4 and lead on "-" side of battery to test higher values of resistance. Next, jacks 2 and 4 may be used as a substitute resistance in various ways, the 0.4-meg. resistor being calibrated and read directly on the scale. Jacks 2, 4, 5 and 6 may be used to get different values of resistances to use as substitutes.

D. E. GANDY

## HONORABLE MENTION

**AN INSTRUMENT CIRCUIT FOR MEASURING A.V.C. VOLTAGES.** Fundamental Circuit: (See Fig. 6A.) When opposing voltages are equal there is a zero current and therefore infinite resistance; the voltage as read on V, is then equal to the source being measured. In the diagram (Fig. 6A) T are the terminals for the voltage to be measured; J is the jack for headphones or micro-ammeter and B the battery supplying the bucking voltage.

Practical Circuit: (See Fig. 6B.)

Important: Proper polarity must be observed in connecting the infinite resistance voltmeter in the circuit under test.

WILLARD MOODY

## SERVICING PUSHBUTTON TUNING SYSTEMS

(Continued from page 19)

It will be found that some stations cannot be tuned exactly to the dial marking, but if they are within 10 kc. it will be taken care of by the A.F.C. which should always be turned on when the automatic dial is used.

Remove the star tab from the escutcheon hole directly beneath the screw which has been set up and insert the proper station tab. This operation is repeated for as many stations as are required.

Figure 13 shows the appearance of one of these dial control screws and the dial escutcheon which holds them. The indexing finger on the control screw sometimes breaks off due to being forced or stuck in the tuning gate, in which case a new screw may be installed without dismantling the dial mechanism. The trick in doing this is to press in on the broken screw while the dial is not set for the station controlled by the broken screw. The screw should be turned until the index finger falls into the pear-shaped slot and upon releasing the screwdriver the screw may be pulled out and the new one inserted in reverse order.

Other troubles which may be encountered in this dial system are: Stuck or broken tuning gate; no A.F.C. action because of defective switch actuated by tuning gate; no signal, or intermittent and distorted signal due to Audio shorting switch trouble on dial-shaft hub.

### G.E. MOTOR-TUNED SYSTEM

The following paragraphs relate to the G.E. Model F107 Service Notes on incorrect operation and suggested remedies.

(1) "Touch-Tuning" button leads not making good contact to stud screws. Clean contacts and re-insert.

(2) Scanning arm blade either covered by thin piece of bakelite or else is dirty. Carefully run a file over the top of the blade, making sure not to leave any sharp corners. Also apply a little vaseline on the beveled surface to prevent chattering.

(3) Scanning arm jumps off because nipple is too sharp on the adjustable stud screw. Smooth off with fine sandpaper.

(4) Relay armature out of adjustment causing sluggish operation of relay switch. In this case it will be necessary to adjust the backstop so that the armature snaps closed when the relay coil is energized with 4.5 volts A.C. The backstop must make a positive contact with the back of the armature in the open position. If the relay will not close at 4.5 volts and still maintain proper travel and sequence, weaken the spring on the rear of the armature plate by bending the stationary spring support.

(5) Excessive side-play in scanning arm blade, causing the knife edge blade to rock from side to side. See Fig. 11 and note that the rocker pin flanges are adjustable by means of a screw in back of the scanning arm. Correct adjustment provides a rocker action, up and down with no side play.

(6) Not enough tension on scanning arm. Loosen collar on shaft at the rear of the sector and push scanning arm toward the sector face, then tighten the collar on the shaft.

(7) If the Button contacts do not close, or else fail to make good contact and hence motor continues to scan dial without stopping at desired station. Bend or clean the button contacts.

(8) Sector has warped away from its vertical position, causing one or more buttons to skip stations. Since the metal is very brittle no attempt should be made to straighten a warped sector. The best remedy is to replace with a new sector.

(9) Control shaft grounds against the dial and pushbutton escutcheon. If this happens the relay remains energized and the motor will not run.

(10) Open or shorted motor condenser causes motor armature to hum but prevents it from turning under load. Replace with a new condenser of the proper type.

(11) Open or shorted coil in motor causes motor to turn very slowly, if at all, and only in one direction. Replace motor or repair coil.

The convenience and advantages of button tuning need not be restricted to today's receivers, only. Button tuning of the trimmer type can easily be added to sets of the superhet. type of the past few years.

As a money-making adjunct for the Service Man, two types of switches are available at present and are shown in Figs. 14 and 15. The circuit-closing type shown in Fig. 15 can also be used in analyzers and test equipment. Figure 16 shows the construction of the "latch" which is common (in one form or another) for practically all pushbutton switches.

The circuit transfer type shown in Fig. 14 uses an ingenious method of progressive switching; that is, a series circuit is maintained up to the point where a button is pressed in, whereupon the series circuit terminates at a lower contact of that button. The author has added a Meissner 8-button assembly of the type just described, to a high-fidelity tuner (June, 1937, *Radio-Craft*). The troubles which may occur in latch switches are very few and easily located.

(This concludes the author's timely, informative and easily understandable article.—Editor)



## Ask your jobber for the NEW CENTRALAB Volume Control Guide

Again . . . the servicemen's most popular guide . . . now available . . . bigger and better than ever.

Lists 10,000 models! . . . 240 pages . . . more than 400 types of radios . . . complete line of midjet Radiohm Replacements . . . Also a complete listing of all other Centralab products: switches, resistors, sound projection controls, and the new Centralab wire-wound Radiohm.

**FREE** at your jobber  
or send 10c to cover handling  
and mailing to CENTRALAB

MEET CENTRALAB AT THE  
NATIONAL RADIO PARTS  
TRADE SHOW  
CHICAGO, JUNE 8-11

**Centralab**  
MILWAUKEE WISCONSIN

Please Say That You Saw It in RADIO-CRAFT

## HOW TO MAKE A HIGH-FIDELITY TUNER

(Continued from page 23)

consists of 4,000 turns of No. 32 D.S.C. wire wound on a bakelite or hard rubber form of the dimensions given. The wire should be wound evenly but not in layers.

The layout of parts can be seen from the photographs (Figs. B and C) and no actual drilling layout is given because of the difficulty of spotting holes exactly, when substitute parts may be employed with a resulting shift of hole locations, etc.

When all parts have been secured to the chassis, the wiring can be done, using well-insulated wire and heavy flexible leads for the filaments which must be fed from the amplifier chassis. The wiring should be as short and direct as possible consistent with a neat and workman-like job. The A.F. output leads should be shielded and the lead from the potentiometer to the grid of the first tube in the amplifier should consist of a heavy shielded wire, using the shielded loom sold for auto-radio antenna leads. This will keep the capacity between the lead and shield at a minimum and prevent bypass (loss) of the high-frequency signals.

With the coils used in this set (it is not advisable to make the coils at home if consistent flat-top resonant curves are to be expected) a coupling capacity of 0.05-mf. produces a selectivity of approx. 20 kc. and with the addition of the 0.01-mf. capacity in parallel with the 0.05-mf. units, the band-width narrows to approximately 15 kc. The use of 0.02-mf. in place of the 0.01-mf. condensers, the band-width narrows to approximately 12 kc., thus permitting adequate control of selectivity for most situations encountered in the U.S.

If desired, a switch can be included to cut the 10,000-cycle filter out of the circuit so that this attenuation of the "highs" may be eliminated when the noise background and monkey-chatter permit. This is not shown in the circuit as the set was made to be used close to New York where the interference is notably bad.

### THE AMPLIFIER

The actual amplifier with which the tuner is used depends on the individual preference of the builder; on the volume level required, and on the pocketbook.

The circuit used by the writer employs coupling transformers which are not commercially available. However, several very fine input and output transformers are available and this should not deter any builder from duplicating the amplifier used in the original model, diagrammed in Fig. 3. Some readers may prefer the use of the triode output tubes to the beam tubes—but as far as available instruments and the writer's ears are concerned, the beam power amplifier gives equally good response and low harmonic content with one less stage than the triode amplifier. (This may be due to the closer match between tube and transformer impedances in the beam amplifier.)

No constructional details are given for the amplifiers as this article is limited to the design and construction of the tuner.

### SUITABLE LOUDSPEAKER SYSTEMS

However, the subject of speakers and baffles should be mentioned as this is the second "weak link" in the chain (the detector being the first, as you will remember). There are several speakers on the market which will respond up to about 6,000 cycles, but to the writer's mind it takes a really good double speaker unit, using woofer and tweeter speakers, to bring out the capabilities of this wide-band tuner.

Also, there is little advantage to be gained in increasing the H.F. response of a set without also increasing the L.F. end. And with this point in mind, a large baffle area or the use of either the infinite baffle, bass reflex or peri-dynamic principle to increase the "lows" cannot be too highly recommended. However, such points must be worked out by the builder in conjunction with the amplifier and actual installation.

This tuner is capable of fine reproduction when used with correct amplifier and speaker equipment—and that is the main part of the battle, as mentioned in the beginning of this article. The completed job in its cabinet is illustrated in Fig. A.

(Continued on page 45)

## MOTO-SCOOT FOR SERVICE CALLS



## FREE THE NATIONAL UNION WAY

● Here's a grand idea for quick, low cost transportation for the service engineer. The Moto-Scoot with side van attached, provides ideal transportation facilities for test equipment, tools or radio chassis.

The Moto-Scoot is safe and easy to operate and unbelievably economical to run. You can get about 120 miles to the gallon of gasoline. The unit is supplied complete, ready to go with no accessories to buy. It is completely equipped with a powerful lighting system. Get it FREE for your business. Ask your distributor for complete details or write.

## USE NATIONAL UNION QUALITY TUBES • QUALITY CONDENSERS

● Thousands of topnotchers in Radio Service are depending on National Union Quality. These tubes and condensers have the kind of precision and value that makes good friends for you too.

● National Union will help you to own "the finest radio service lab in town." Everything you want is offered you on a "Free Deal" Plan. It will help you to get the equipment you need now to do better work and faster work and make more money. That's the National Union way. Over 100,000 completed deals . . . . for more details, just write . . . .

SEE US AT BOOTHS 205-207—Hertz Ave.  
CHICAGO RADIO PARTS SHOW

**THE ROAD TO BETTER BUSINESS**

1. Full guarantee on highest quality radio tubes. 2. Cut price business not solicited. 3. Price Protection.

4. N. U. jobber stocks are complete...No hunting for odd types. 5. Timely business building aids.

NATIONAL UNION RADIO CORPORATION  
57 State St., Newark, N.J. RC-738

Please send me more information on:

- Moto-Scoot  
 Other N.U. "Free" Offers

Name .....

Address .....

City ..... State .....

## Be a RADIO EXPERT—Learn AT HOME

### RADIO SPECIALISTS NEEDED

Modern receivers with their complicated circuit systems have knocked out the old time cut-and-try radio fixer. Trained men with up-to-the-minute knowledge are needed to service these new sets.

### HERE IS YOUR OPPORTUNITY

Your possibilities of making money and getting ahead are limited only by your ability and skill—but you must know more than the other fellow. You must be a radio service specialist, as R.T.A. can train you.

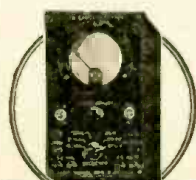

**FREE OF EXTRA COST**

To start you making money without delay we equip you with this Circuit Analyzer and Point to Point Resistance Tester.

### PRACTICAL TRAINING AT HOME

Our home study course is practical "shop and bench" training combined with a thorough set of practical lessons prepared by an experienced Radio service engineer. Four working outfits are also furnished.

### MAKE SPARE TIME MONEY

Our training is complete and practical. We show you how to make money almost from the start. The course can easily be made to pay its own way. Investigate now, write for free book of details.

### WHAT R.T.A. STUDENTS SAY

Norwood, Ohio  
I have connected with a large firm as Radio Service Manager and wish to extend my thanks for your help.  
Joseph Radien, Jr.

Yorkville, Ohio  
From Aug. 1 to Dec. 7, 1936, I repaired 163 radios and put up 43 aerials which is very good for part time work while studying your course.  
Clas. Koerber.

**RADIO TRAINING ASS'N OF AMERICA**  
Dept RC-78, 4525 RAVENSWOOD AVE., CHICAGO

Please Say That You Saw It in RADIO-CRAFT

**FREE**  
..tells how to  
**SAVE MONEY**  
ON EVERYTHING YOU BUY!



**NOW READY**—big new Bargain Bulletin. Describes, pictures hundreds of amazing values. Tell us where to RUSH your FREE COPY:—

**YOU** can save many Dollars on your purchases out of this new Bargain Bulletin—on Radio Sets and Parts, Sporting Goods, Watches, Clocks, Cameras, Typewriters, Electrical Specialties, Novelties, and scores of other articles. Thousands of smart buyers have discovered this sure way to save money on standard, highest quality merchandise. You get prompt, courteous service, complete reliability. Get PROOF of big savings—take your pick of the amazing values shown to fill your present needs.

**YOUR FREE BARGAIN BULLETIN IS WAITING** Fill in and mail NOW the coupon below—or send postal or letter. No obligation. Some bargain offers limited—rush your request while stocks are at their best.

**RADIO CIRCULAR CO., Inc.**  
915 Broadway (Dept. R.C.), New York, N. Y.

**MAIL THIS COUPON NOW**

**RADIO CIRCULAR CO., Inc. (Dept. R.C.)**  
Yes, rush my Free Bargain Bulletin.  
No obligation to me.

NAME \_\_\_\_\_

ST. & NO. \_\_\_\_\_

CITY & STATE \_\_\_\_\_

**FORMULAS AND RECIPES**  
For the Practical Man

Here Is the Contents of the Book

1. Adhesives: Glues, Cements, Gums, Mucilages, Lubricants.
2. Cleansing: Stain Removers, Paint Removers, Bleaches, Cleaning Fluids.
3. Metal Craft: Coloring, Oxidizing, Plating, Repairing, Welding, Polishes, Alloys, Solders, Amalgams.
4. Paints: Colors, Stains, Varnishes, Enamels, Luminous Paint, Washable Paint; Paint-Removing, Water-proofing, Fire-proofing.
5. Glass-Working: Cutting, Drilling, Boring, Bending, Blowing, Etching, Engraving, Frosting, Silvering, etc.
6. Wood-craft: Fillers, Fire-proofing, Acid-proofing, Water-proofing; Furniture Polishes, Finishes, etc.
7. Inks: Recipes, Eradicators, Ink Stain Removers; Special Inks: Colored, Indelible, Sympathetic, Invisible, Hectograph.
8. Photography: Developers, Emulsions, Fixers, Sensitizing, Toning, Printing, Photographic Paper, Blueprint Paper.
9. Antidotes for Poisons, Remedies for Burns and Scalds, Disinfectants, First-Aid in Accidents, Emergency Remedies, Home Remedies.
10. Preparation, Manipulation, Handling, Mixing, Measuring, Weighing, Filtering, Straining Solutions; List of Technical Substances; Emulsifying; Use of Hydrometer, Use of Thermometer; Tables of Weights and Measures, Decimal Systems, Useful Tables.

PRICE  
**50c**  
POSTPAID

**TECHNIFAX**

Division RC-738  
558 W. WASHINGTON BLVD. CHICAGO, ILL.

**FREE!**

**HAMMARLUND**  
NEW "38"  
RADIO CATALOG



The latest Hammarlund catalog with complete data, illustrations, drawings and curves on the entire Hammarlund line. Address Department RC-7-38 for your free copy.

**HAMMARLUND MFG. CO., INC.**  
424-438 West 33rd Street, New York City

**THE RADIO MONTH IN REVIEW**

(Continued from page 7)

**THE WAR OF WORDS**

**T**HOSE nations which are not actually engaged in the pastime of hurling lead and gas at each other, either at home or in their neighbors' yards, were throwing words at each other's nationals, according to last month's advices. So far that matter, were the warring nations.

Britain last month inaugurated a "news service" in Spanish and Portuguese for listeners in Latin-America. C.B.S. announced a short-wave service of stock market reports and Press-Radio news, directed at Europe. Frank E. Mason, N.B.C. vice-President, was assigned to supervise spreading "American culture and ideals" to Europe and South America; news, entertainment and "other programs" will be featured. France, at last reports, was busily hunting a station which purported to be in Paris, and which took pokes at the Blum government. No word of this station has been received since Blum was supplanted by Daladier; maybe it stopped transmitting, or perhaps the French just ceased to care. From Latvia came reports of a short-wave station which advocated the overthrow of Stalin; and no one knew whether it was in Russia or in one of the nearby independent states—nor, for that matter, who owns it. Japan announced plans for the greatest radio coverage of the 1940 Olympics in history; the transmitter and antenna of the Denwa Kaisha station in Ibaragi will be improved and enlarged in time for the games. A Pan-American short-wave service, stressing "good will," was inaugurated over WIXAL.

An international convention on "broadcasting in the cause of peace" was held at Geneva last month. Twenty-eight states signed the pact. Among the absentees were Germany, Japan, Italy and the United States. Signatories pledged themselves to ban broadcasting which might foment revolt in other countries, incite to war, or to harm international relations through deliberate untruths. There appears to be no reference to any harm which might be done to such relations by the broadcasting of a few well-chosen truths.

**SOMEBODY'S MAKING MONEY**

**E**NCOURAGING reports drifted in from scattered radio sources last month. For February, C.B.S. grossed \$2,681,735, an increase of 18.4% over 1937. N.B.C.'s gross of \$3,498,053 was 6.1% up; and M.B.S. advanced 12.4% for a gross of \$265,532. In March, the picture was not quite so uniformly beautiful. While N.B.C. and C.B.S. had a record month, Mutual slipped slightly. The figures, with percentage of change from March, 1937, are: C.B.S., \$3,055,929, up 19.4%; N.B.C., \$3,806,831, up 5.3%; M.B.S., \$240,637, down 2.7%. These statistics are quoted from *Radio Daily*. The listening public, which indirectly pays the bills through its purchases of advertised products, was said by the *World Book Encyclopedia* to be operating 36,800,000 sets, 5,000,000 of which are auto-radios. Figures issued by Andre Kostelanetz in an interview were 6,000,000 short of the foregoing. (The B.B.C.'s income, by the way, was approximately \$17,000,000 for the year of 1937, about \$14,000,000 being license fees paid by listeners.)

Radio manufacturers, too, made money. Electrical exports were 24% up for 1937, that being the best year since 1930. Radio exports totalled \$32,102,070, an advance of 13.52% over 1936. But the month of February was 32% below February, 1937, though above the preceding month, according to last month's reports. Incidentally, any radio exporter who does not receive the U. S. Department of Commerce bulletins, *World Radio Markets* and *Electrical and Radio World Trade News*, is missing some great tips on market conditions at the ends of the earth.

Last month the Radio Manufacturers' Association announced a meeting on sales promotion to be held on April 21, and on the 26th to discuss minimum wages and maximum hours for the industry. The R.M.A. fight to repeal or reduce the excise tax failed, but leaders consoled themselves with the thought that it would probably expire in 1939, anyway. The Association also released figures on its employment situation, as of January. There was a decrease of

21.6% from December. Radio factory employees averaged \$20.88 per week—which is slightly more than a dollar under the average wage of all manufacturing industries.

The General Electric Company's annual report, released last month, showed sales up 30% to \$349,740,000 in 1937; dividends were \$2.21 per share, as compared with '36's \$1.50; taxes up 54% to \$23,266,000; employee earnings up 36% to \$145,358,000, and average annual wages \$1,933, a rise of nearly \$200. Expenses also included about two-and-one-half million dollars in pensions, etc. And a month after this report, the company announced that all full-time employees earning over \$2,000 a year would receive pay cuts ranging from 0.5- to 20%. The plan was adopted to avoid large-scale layoffs.

Last Minute Flash—G.E.Co.'s orders for first quarter of 1938 were 38% below those for a like period in 1937. Last month 204,980 stockholders received 30c a share; year before, 193,364 stockholders received 40c a share, as their quarterly dividend.

**RADIOFFICIAL REGULATIONS**

**YOUR** Reviewer, who is able to top off a bottle without receiving any sensation, and who can cross the English Channel with nary a qualm, always has a dizzy spell when plowing through the quires of paper emanating monthly from the F.C.C. Commission.

Robbed of most of their *whereases*, genial Chairman McNinch announced last month that he would head committees to investigate "chain broadcasting and monopoly in the broadcasting industry" and to prepare for and hold hearings relative to relaxing the regulation limiting the power of stations on clear channels. The Committees will recommend action to the F.C.C.

Police stations were notified that adequate provision must be made for checking and maintaining frequency.

Ship stations were advised last month that certain transmitters designed to produce 200-watt A-1 transmission would not have the same output when A-2 transmission was employed, and so must be altered.

Last month F.C.C. Commissioner Craven made public a criticism of the F.C.C. investigation into Telephone communications. Pointing out that he was not a member at the time, he deplored the fact that the press received news of the report before Congress did. He also remarked that it would have helped matters had the phone company been permitted the right of cross-examination and rebuttal. He suggested that the report be submitted to the I.C.C. of the Senate and the I.&F.C.C. of the House. This was done.

Commented Walter S. Gifford, President of A.T.&T., in part last month on the F.C.C.'s "proposed report" on the telephone investigation:

"The investigation . . . was one-sided from start to finish. We were denied not only the right to cross-examine investigation witnesses and to be heard in our own behalf, but were denied the right to have included in the record written material which we had prepared and considered necessary to point out serious and important errors affecting most of the investigators' reports. Commissioner Walker's report must be appraised in light of these facts.

"We have not been given a copy of Commissioner Walker's report, said to contain 1,000 pages, but if the summary of it correctly reflects the report, it presents much that is simply not true and has been prepared with the same unfairness that characterized the investigation proceedings."

The report, which runs to 22 pages, cost \$1,500,000 being derived from a complete record of 8,441 pages and more than 2,000 exhibits. Summed up, it recommends giving the government greater power to regulate the operation of telephone companies, with a view toward reducing the cost to consumers. Mr. Craven points out, however, that investors must be protected, and that the jobs of telephone workers must not be put in jeopardy.

The same Commissioner also released data on his questionnaire, being sent to all stations to secure information as to their earnings and investments. The M.B.S. announced its approval of the F.C.C. investigation into chains, and pledged its support, last month.

Please Say That You Saw It in RADIO-CRAFT

Another ruling of last month extended for 6 months (from March 15) the time in which relay, international, television, high-frequency, facsimile and experimental stations might get their frequency monitors working. The reason: lack of the requisite monitors, which must be accurate to within 1/2 the tolerance allowed.

Constat stations were chided for transmitting a series of dashes or "V's" to check their frequency. Reason: it sets off automatic alarms. Checking ship logs revealed this.

Non-commercial educational broadcasting stations were defined last month, and were given a set of extra rules, in addition to those governing high-frequency stations. Such non-profit stations are permitted to conduct point-to-point work, in order to service specific schools. Twenty-five channels between 41,000 kc. and 42,000 kc. have been allocated for such service.

Meanwhile, the ratification of the international radio treaty, arranged at Havana last year, is delayed. The F.C.C. objected to its receiving Senate approval last month; therefore it lies sleeping peacefully in a State Department pigeon hole. If Congress gives itself a vacation before ratifying the treaty, radio may wind up in something of a bobble, with Mexican and Cuban stations using waves now enjoyed by U.S. broadcasters, thus causing serious interference.

**RADIO MISCELLANY**

**F**ACSIMILE will be adapted particularly to the transmission of news, and relevant to this is *Fortune Magazine's* survey of how the public gets its news. The percentages, given last month, are:—newspapers, 45.2%; radio and newspapers, 28.2%; radio, 23.5%; neither, or "don't know," 3.1%.

Meantime, station worries increased last month, with the beginnings of a newspaper boycott facing radio columns and program listings. Started in Los Angeles, publishers feared its spread to other sections of the country. Developments were expected at the A.N.P.A. convention.

Aurora Borealis moved in on the northeast part of the U.S. last month. Her antics not only marred broadcasts, but also hampered telephone communications.

Last month British manufacturers commenced a campaign on self-contained crystal sets, of a type known as A.R.P., which signifies "Air Raid Portable." The idea is that if Civilization comes to Britain, its bombs may wreck power plants, but subjects will still be able to hear government broadcasts telling them the safest places to crawl in and hide, etc.

A radio-equipped balloon, sent up by the U.S. Weather Bureau, set a new altitude record of 17.8 miles last month. Would that the stock market would follow!

A new distortion reducer, tested out at WEAF and WJZ last month, cut transmitter distortion to 1/30 its former level! Plans were announced to install it at all N.B.C. stations. It employs the reverse-feedback principle, to cancel out transmitter harmonics.

Czech authorities last month sentenced to death a man with a short-wave transceiver. He was acting as a spy for an unnamed "neighboring state."

Sixty yachts and cruisers along the Atlantic coast were equipped with transceivers which enabled them to be radio-linked to shore telephone lines last month. Cost of equipment varies from \$500 to \$4,000, without "scrambler" that insures secrecy of communications. Most yachtsmen don't want it, anyway.

Last month London papers printed reports (but no details) of a marvelous radio ray, said to be capable of detecting "parked" submarines as much as 15 miles away. There is no record of any tests being made in the Mediterranean.

KYW's \$600,000 station was scheduled to open on May 16. Features are: 7 stories, air conditioning, 6 floors entirely devoted to radio (2 of them to television); mammoth studio in basement—5 other studios, visitors' galleries; 718-foot triangular antenna is to be world's tallest. Power will be 10 kw. with application in for 50 kw.

**RADIOODDITIES**

**L**IGHTNING sneaked down a lead-in and climbed into bed with a Wisconsin youth last month. He was not hurt by the resulting blaze.

The Marx Brothers (Groucho & Chico) last  
(Continued on following page)

**BY POPULAR REQUEST!**

**NO DOWN PAYMENT!  
10 DAYS FREE TRIAL!  
ON ANY SUPREME INSTRUMENT!**

**CONTINUED UNTIL JUNE 30TH**

Because of thousands of requests to continue our "no down payment—10 days' free trial offer" we are extending the expiration date to June 30th! This will give hundreds of more dealers and servicemen an opportunity to re-equip and modernize now with new, modern SUPREME instruments—at the most liberal

terms ever offered in the instruments industry!

See your parts jobber today. Pick out any Supreme Instrument without paying one penny down! If it doesn't measure up to your expectations after you've tried it for 10 days—ship it back to us without any obligation on your part!

**NOW! FOR THE FIRST TIME IN A SIGNAL GENERATOR  
PUSH-BUTTON TUNING!**



Again SUPREME is first with the latest! Model 582-A Signal Generator offers you new, exclusive, rapid, amazingly accurate push-button-tuning for most used IF and RF frequencies PLUS complete frequency coverage on manually tuned dial. Use the push-buttons with easy-to-read figures for almost all your alignment problems—catch the "in-betweens" and "high freqs" with the manual circuit which has hair-line, shadow-indicating, spotlight tuning on giant dial.

In addition you get the following exclusive features: (1) Wide Frequency Coverage (2) Air Tuned Trimmers and Special Iron-Core Inductors for more Accurate Calibrations (3) Four types of Output (4) Automatic Electronic Frequency Modulation (5) Razor Edged Tuning on Giant Dial (6) Specially Designed Attenuator Circuits, etc.

See the new Model 582-A at your parts jobber or write for literature.

Visit the Supreme booth at the Radio Parts Show, Booths 212 and 214 Hertz Ave., Stevens Hotel, June 8, 9, 10 and 11, Chicago.

**MODEL 582-A—PUSH-BUTTON SIGNAL GENERATOR  
NO DOWN PAYMENT AND \$6.14 PER MONTH FOR  
12 MONTHS OR CASH PRICE—\$695**

**MODEL 582—SIGNAL GENERATOR (without push-  
buttons) NO DOWN PAYMENT AND \$5.50 PER MONTH  
FOR 12 MONTHS OR CASH PRICE—\$595**

**SUPREME INSTRUMENTS CORP.**

**GREENWOOD, MISSISSIPPI, U. S. A.**

**EXPORT DEPT., ASSOCIATED EXPORTERS CO., 145 W. 45th ST., NEW YORK, N. Y., CABLE ADDRESS: LOPREN, N. Y.**

**Action! Thrills! Sights! Fun!—  
In Every CANDID CAMERA Shot!**



The country's new craze—CANDID CAMERA Shooting. Everyone from north to south—east to west is using a minicam. Anywhere you go—day or night—under any conditions, there're thrills taking CANDID CAMERA pictures. In a flash you catch your subject—a popular golfer, a screen or radio star, a ball player, your children, an action scene—anything you want.

This minicam, popularly priced at \$3.98, is comparable to others selling at a much higher cost. It takes 16 pictures, either instantaneous or time exposures. Equipped with Wollensak 50 mm. strong lens, speed shutter and accurate "spy glass" view-finder. Fixed focus guarantees sharp pictures, 1 1/2 x 1 1/2 inches. Enlarges with clarity up to 8x10 inches. Has special compartment to carry extra film roll and tripod socket for mounting. Uses economical Kodak 127 or Akfa A8 film in color or black and white. Housing built of unbreakable Bakelite-Composition. Camera weighs only 9 ounces, measures 5" long x 3" high x 2 1/4" wide. Easy to operate and extremely inexpensive to use.

Shipped POST-PAID anywhere in U.S.A. with guarantee of safe delivery .....

**\$3.98**

**HUDSON SPECIALTIES COMPANY • 40R West Broadway • New York, N. Y.**

## SEEKING RICHES FROM THE EARTH BY RADIO

**S**TEADILY the technique is developing for the location of precious ore bodies and other mineral deposits in the earth by using radio. A very comprehensive article has been prepared, revealing circuits and methods, all based on verified experiments, giving full insight into this fascinating and promising field. By using methods now fully disclosed, gold coins, buried by prearrangement, were recovered, to the consternation of amazed onlookers.

All the world over, the eager search for the riches reposing in the recesses of the earth goes on. Success attends those efforts that scientifically determine the non-homogeneous character of the earth. Interpretation of these findings determines the straight path to precious deposits.

Acquaint yourself with the full facts about the earth as a treasure chest, and the exploration by radio devices by those seeking riches. Be among those fully conversant with the requirements for successful apparatus. Join in the treasure-seeking yourself. The full details are revealed in this article that treats of this historic development of methods of wresting the secrets from the earth, from the first divining rod to the latest high-powered beat oscillator. Remit with order.

**25¢**  
POSTPAID

**RELIABLE RADIO COMPANY**  
143 West 45th Street, New York, N. Y.

**Greatest Screwdriver  
A Radio Man  
Ever Used  
in Servicing  
or in a Laboratory**

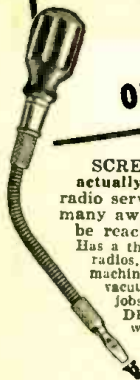

**USE** this FLEXIBLE SHAFT SCREWDRIVER—the screwdriver that actually goes around a corner—in your radio service work or laboratory. It reaches many awkward places where a screw cannot be reached by a straight or offset driver. Has a thousand and one uses—ideal for repairing radios, refrigerators, automobiles, oil burners, machinery, shop equipment, electrical appliances, vacuum cleaners, marine equipment, household jobs, etc. The FLEXIBLE SHAFT SCREWDRIVER has a shaft of laminated steel wire—tempered steel blade—chromium-plated fittings—fluted, hard-wooden handle—length over all 8". **PRICE, POSTPAID \$1.00**

**GRENPARK COMPANY • 1229 Park Row Bldg. • New York, N. Y.**

**GRENPARK COMPANY** RC-7-38  
1229 PARK ROW BLDG., New York, N. Y.  
Gentlemen: Enclosed you will find my remittance of \$1.00 (One Dollar) for which please send me, **POSTPAID** one FLEXIBLE SHAFT SCREWDRIVER.

Name .....

Address .....

City ..... State .....

## THE RADIO MONTH IN REVIEW

(Continued from preceding page)

month lost their appeal on a radio program plagiarism conviction. The fine remains at \$1,000.

French prisons adopted a radio mattress-tester last month. It finds knives, guns, saws, files, etc., when such gadgets are concealed in convicts' beds.

To keep skiers from becoming lost, a beacon system was established in a Swiss resort last month. It sends out a beam, which the radio-equipped slalomers may follow back to safety. This may mean unemployment for the St. Bernard dogs, even though no one has invented a radio wave which is able to carry a cask of brandy.

The Batchelors Pea Cannery, Sheffield, England, installed radio in its sorting room last month. It makes the hundred girls work faster.

Paul Wilson, Illinois farmer, no longer has to call his hogs to dinner. Last month they learned to come when he tunes in a hill-billy program on his barn radio. So now you know who likes hill-billy music. (P.S. His cows and horses come, too.)

Money-making through radio! A woman living next to the M-G-M studio received \$25 per day not to run her radio last month. The sound interfered with recording.

Ancient alchemists sought means to transmute base metals into gold. Scientists at the University of Rochester, however, put gold into their 5½-million volt atom smasher last month and turned the switch. The gold became mercury. As the Two Black Crows used to say, "You can't make any money like dat!"

When you tune-in an all-request phonograph program at midnight, there's a good chance you are listening to some secret code for the rackets, according to reports of an F.B.I. investigation last month. The racket boys were coding their messages by combinations of song titles, requesters' names and addresses. Many stations now omit reading of telegrams, this having been a popular form of coding.

British programs, being government-regulated, carry no advertising. London's *Reynolds' News* suggested last month that British advertisers buy time on American short waves. Those from Schenectady and Pittsburgh, it was said, are heard in England regularly, and with good volume.

## CAUGHT ON THE FLY

New York's mayor, F. H. LaGuardia, last month expressed his regrets at his inability to attend the Police Department's Communion breakfast. At home, he listened-in on his radio. Former Judge Bleakely, speaking at the breakfast, criticized the mayor for party irregularity. Mayor LaGuardia leaped into his car, sped to the breakfast, and broadcast his reply.

The municipal station's most popular program is the weekly broadcast of the deliberations of the City Council, according to a statement issued last month by S. N. Siegel, director of WNYC. The station receives about 1,000 letters per program. "Some of the letters are derisive," Dr. Siegel admits. "The meetings are called circuses." (Editor's Note:—Our own little group calls 'em "The Hyena House.")

Radio boosts for the New York World's Fair were started over a local station last month. Plans were announced for the inauguration of network publicity, as well.

The Golden Gate Exposition (1939 World's Fair of the West) likewise made advances last month. The Exposition will feature television, electronic music, demonstrations of "atom smashing" and so forth.

N.B.C., month before last, devoted a complete News Service release to taking bows for its Toscanini series. Release showed the mild maestro and the orchestra; quoted tributes from press and public.

Pitcairn Island, isolated since 1790, hit the news last month. In 1920, one of the Islanders erected a station. Last month, CoCo-Coil engineers increased its power from 50 to 650 watts. Station owner began broadcasting praises of engineers and cluttering up wavelengths. Britain issued orders restricting Island's communications to passing ships, its radio power to 80 watts. Red-faced, N.B.C. canceled arrangements for Island broadcasts.

New York candidates for teachers' positions last month faced a microphone and recorder for oral speech tests, while examiners listened. Ex-

aminers graded what they heard, then listened to records. Records revealed more faults than examiners had heard on their first listening. Disgruntled candidates demanded re-exams. Alibi: "mike fright."

Every year since the advent of radio, some newspaper prints a story about the use of radio in the barn to increase milk production. Last month the N.Y. *Daily Mirror* was no exception.

In Hawaii last month, Japanese and other non-government craft were barred from Pearl Harbor during naval maneuvers. War games took in the civilian population, who were asked to listen-in on a special military wavelength "which might be used in case of an emergency or catastrophe." They were urged to use auto-radio and other battery sets, "as if power companies had been destroyed."

Radio may speed up communications, but it slows up homing pigeons, 'tis said. Pigeons released near W9XF did not behave normally; took 10 minutes longer to fly 30 miles. Commentators say this study of effect of radio waves may be extremely important. It doubtless will be—to the pigeons whose time is so wasted.

A super-station being erected outside of Paris, France, was reported as coming along nicely last month, with the antenna nearly completed. The station will probably go on the air in June.

Last month Vienna police took on the appearance of camera fans. Selected officers were provided with small portable transmitters, to be worn slung over their shoulders. Batteries were carried in their pockets. Yet *anschluss* took place, just the same.

In Egypt last month, the King's bounty brought happiness to thousands of his poor but honest subjects. He commanded that 3,000 radio sets be distributed among impoverished peasants in the Nile Valley. Only fly in the ointment was that he also decreed an increase in educational broadcasts.

Irish Tenor Morton Downey, returned from Europe last month, praises American broadcasts. He remarks that European broadcasts are propaganda-packed—are permitted to run short or long of their allotted time—that there are long pauses between them. Yet there are times when your Reviewer would substitute an itty-bitty pause for an over-long commercial.

English spellers, defeated by an American group in a trans-Atlantic spelling bee early this year, came back last month to avenge their defeat. The score, 27-37.

Amateurs may recall Eric Palmer, operator of W2GRB, and author of "Riding the Airwaves." Mr. Palmer, now a member of the WQXR engineering staff, married Miss Lillian Kaprat last month.

When a Navy bombing plane was lost last month, among its crew were George T. Williamson, radioman, 1st-class, and C. R. Oulundsen, radioman, 3rd-class.

The police of Hove, England, were given radio equipment last month, so you'd better stay away from there if your conscience hurts.

RCA stockholders last month passed a motion accepting RCA President David Sarnoff's report with thanks. Their only other motion called for a radiogram carrying the greetings and felicitations of the stockholders to Gen. James G. Harbord, Chairman of the Board of RCA, who was then in Australia representing the company at a World Radio Conference. Guess what system was used to send the message. You're right!

The spectators of the Oxford-Cambridge Boat Race last month were kept apprised of the boats' positions by means of 31 giant loud-speakers.

Acoustics will be demonstrated in a room being built by the University of California for the 1939 World's Fair—the one in California, not the one in New York. According to reports received last month, the room will illustrate why singing in the bathtub has become one of the nation's leading indoor sports.

In Canada last month, radio receiver licenses were upped 4 bits to \$2.50 despite the wails of listeners. A Toronto organization made a survey of 24,000 listeners, of whom only 38 considered the increase justified. Others protested that they listened to U.S. stations most of the time anyway, and did not see why they should be called upon to contribute more heavily to the Canadian system. Extra loud howls came from owners of more than one set—who must pay \$2.50 on each. Battery set owners were less bothered; their fee remains at the \$2.00 mark.

Please Say That You Saw It in RADIO-CRAFT

# TECO TEST EQUIPMENT Sold with a GUARANTEE & 10 DAYS FREE TRIAL!!!

Buy direct from the factory on 10 Day Trial. If the Instrument you buy does not meet your needs, return it for full credit on any other TECO equipment. Buy TECO and SAVE the difference!

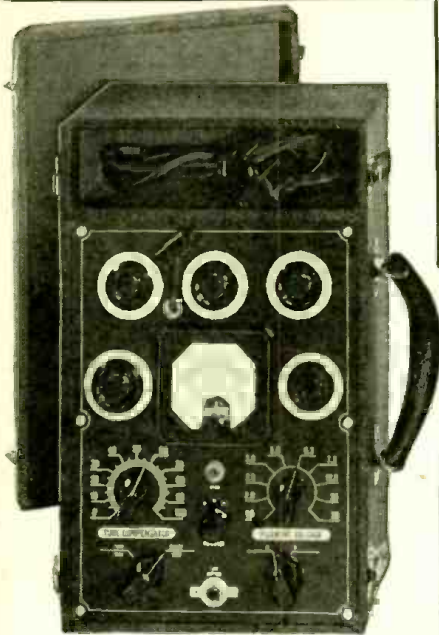

## NEW TECO TUBE TESTER

**Model T-10** A genuine achievement! For accurate and rapid work. Has d'Arsonval moving coil meter. Tests all types of tubes. For use on 110 V., 60 cycle AC.

**Features** • Tests all 4, 5, 6, 7s, 7L and 8A type tubes. • Tests by the well established emission method for tube quality, directly read on the Good & Bad scale of the meter. • Affords separate neon test for leakage and shorts between elements. • All services performed with 5 controls at maximum—many tests not requiring all controls. • Modern attractive etched panel housed in rugged leatherette carrying case with removable blinged cover and handle. • 60 cycle AC operation. • Supplied with instructions and reference table covering all tubes which you will commonly encounter in servicing. Size 11 1/2" x 9 1/2" x 5 1/2". Net Price.....

**\$11<sup>75</sup>**

## TECO POCK-O-METER AC and DC

A new pocket size volt-ohm-milliammeter that includes AC measurements and is the lowest priced, full-service instrument ever offered! Has 3" d'Arsonval movement 0-1 milliammeter. Comes with etched panel.

### SPECIFICATIONS

5 DC ranges: 0/1.5/15/25/75/500 volts.  
5 AC ranges: 0/15/40/75/200/1200 volts.  
4 DC current ranges: 0/1/10/100/500 ma.  
2 resistance ranges: 0/500/500,000 ohms (low ohms read to 1 ohm)  
Pock-O-Meter supplied complete with batteries, test leads, and instructions. Size 6 1/2" x 3 1/2" x 2 1/2"; shpg. wgt. 5 lbs. Our net price.....

**\$8<sup>45</sup>**

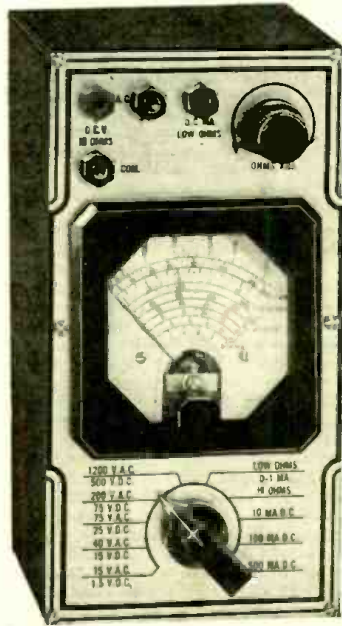

## NEW TECO MULTIMETER

**MODEL T-15** Here's the unit you need for rapid, accurate measurements. A 1000 ohms per volt type instrument featuring d'Arsonval type movement 0-1 Milliammeter. Accuracy 2%. Attractive etched metal panel. For use on 110 V., 60 cycle AC. 2 RESISTANCE RANGES: 0-500 ohms, 500-5 megohms. HIGH AND LOW CAPACITY SCALES. 0.005-1 mf. and .05-200 mf. COMPLETE AC and DC VOLTAGE and CURRENT RANGES. DC Voltage: 0-15, 0-150, 0-750 volts; AC Voltage: 0-15, 0-150, 0-750 volts; DC Current: 0-1, 0-15, 0-150, 0-750 ma.; AC Current: 0-15, 0-150, 0-750 ma. THREE DECIBEL RANGES. TECO Multimeter comes complete in carrying case with test leads and instructions. Size 11 1/2" x 9 1/2" x 5 1/2". Shpg. wgt. 8 lbs. Our net Price.....

**\$13<sup>60</sup>**

Free New Catalog Just Off the Press—Shows Entire Line—Send for Yours to



# TEST EQUIPMENT COMPANY of America

139 CEDAR STREET

RC-7

NEW YORK, N. Y.

## KILLED BY RADIO

A warning about using electrical apparatus in the vicinity of water was issued yesterday by the Stockport coroner.

Recording a verdict of death by misadventure, Catherine Victoria Lightfoot, aged 36, of Bramhall, who was found dead in her bath with a wireless ("radio"—Ed.) set partially submerged in the water, the coroner said he wanted to warn the public about the little-known dangers with which they might be confronted when handling electrical apparatus.

It was apparent, he added, that the woman had received an electric shock through handling the wireless set while she was in the bath.

Medical evidence was that death was due to shock from electricity of a high voltage.

(The above item, reprinted from a recent issue of the *Sunday Referee* (London, Eng.), is offered with the idea that "an ounce of prevention" . . . etc.)

## FLASH!—NEW TELEVISION RECEIVER ANNOUNCED!

As we go to press we learn that a manufacturer has announced the immediate availability of a 441-line cathode-ray type television receiver. Read August *Radio-Craft* for more details!

## HOW TO MAKE A HIGH-FIDELITY TUNER

(Continued from page 41)

### LIST OF PARTS

- One set of coils, type 472A antenna, 472RF, (2) 472 BP band pass, (2) EL56 negative mutuals, and 472UT, untuned. L1 to L7 incl.;
- One 4-gang 350 mmf. variable condenser, C1 to C4;
- One 2 section 3 position switch (open-circuit type), Sw1, Sw2;
- One replacement 10 kc. filter type 446-2H with C102 85 mmf. condenser, L8;
- One Centralab 0.5-meg. volume control (A.F. grid taper), with switch VC;
- One 420 mhy. coil, home wound, L9;
- Three Cornell-Dubilier mica condensers, 0.05-mf.;
- One Cornell-Dubilier mica condenser, 0.06-mf.;
- Two Cornell-Dubilier mica condensers, 0.02-mf.;
- Two Cornell-Dubilier mica condensers, 0.01-mf.;
- One Cornell-Dubilier mica condenser, 0.002-mf.;
- One Cornell-Dubilier mica condenser, 50 mmf.;
- Seven Cornell-Dubilier paper condensers, 0.01-mf., 400 V. D.C.;
- One Cornell-Dubilier paper condenser, 1 mf., 400 V. D.C.;
- Three Continental Carbon resistors, 0.1-meg., 2W;
- One Continental Carbon resistor, 20,000 ohms, 2W;

- Three Continental Carbon resistors, 25,000 ohms, 2W;
  - Two Continental Carbon resistors, 3,500 ohms, 2W;
  - One Continental Carbon resistor, 300 ohms, 2W;
  - One Continental Carbon resistor, 600 ohms, 2W;
  - Two Continental Carbon resistors, 0.5-meg., 2W;
  - One Continental Carbon resistor, 1 meg., 2W;
  - One Continental Carbon resistor, 75,000 ohms, 2W;
  - One Continental Carbon resistor, 4,000 ohms, 2W;
  - Three octal wafer sockets;
  - One 6-prong wafer socket;
  - One dial (type to suit installation);
  - One mounting and escutcheon plate for tuning-eye tube;
  - Two 2-contact terminal strips;
  - Three screen-grid clips;
  - One glass tube shield;
  - Two RCA type 6K7 metal tubes;
  - One RCA metal-glass type 6C8G tube;
  - One RCA 6G5 tuning-eye tube;
  - One 8 x 8 x 3 in. deep chassis;
  - Miscellaneous grommets, wire, screws, etc.
- \*Most Radio mail order houses can supply this item if properly identified as to title of article, issue (month) of *Radio-Craft* and year.

Please Say That You Saw It in RADIO-CRAFT

## SERVICING UNIVERSAL A.C.-D.C. RECEIVERS

(Continued from page 15)

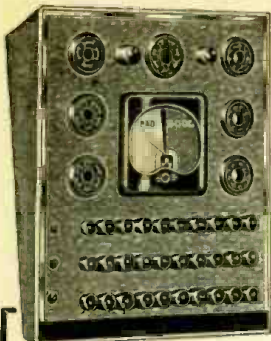

**- Only  
\$17.95**

for this new  
Universal "Push  
Button" Tube  
Checker

See it  
at the  
SHOW

- Direct Push Button Test
- New Easy Reading Scale
- Tests all Standard Tubes
- New Precision Design
- Looks like a Million

Outstanding in performance, precision and design. Universal for all tubes with the convenience of direct "push button" readings.

**MILLION RADIO and TELEVISION LAB.**  
559 NO. UNION ST., CHICAGO, ILL.

Listen Comfortably

WITH

**BRUSH  
"Hushatone"**  
(pillow speaker)

Put this radio accessory under your pillow and listen to your favorite programs. Write for details.

**THE BRUSH DEVELOPMENT CO.**  
3312 Perkins Ave., Cleveland, Ohio

### A New Development in Acoustics BI-PHONIC REPRODUCERS

BI-PHONIC housing—a really new development in acoustics—instead of damping-out the rear response actually utilizes the loudspeaker's backwave. Frequency response at both low and high ends of the audio-frequency spectrum is greatly increased. Volume and definition are tremendously increased.

A complete description of BI-PHONIC REPRODUCERS—and their advantages sent on request.

BI-PHONIC REPRODUCERS are available from \$25.00 up.

BI-PHONIC REPRODUCER  
LABORATORIES  
45 Ashland Ave.,  
Baldwin, L. I., N. Y.

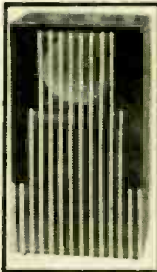

This is the latest development in Dry Electrolytics . . . and all the radio world is in favor of it! Ask for catalog.

Solar Mfg. Corp., 599-601 B'way, N.Y.C.

**DO YOU LIKE  
RADIO  
&  
TELEVISION**

If you want to know employment opportunities and requirements in radio and related industries, get National's book of facts. Send for YOUR FREE COPY TODAY Dept. RC-7 4000 S. Figueroa

**NATIONAL  
SCHOOLS**  
Los Angeles

2 tubes supply sufficient power for loudspeaker field coil excitation, and hence a dynamic loudspeaker will usually be found. A single 12Z3 tube cannot, however, supply enough current for both the loudspeaker field coil and the receiver circuits and last a normal length of time.

Another power pack circuit using a 25Z5 rectifier tube is shown in Fig. 5. Here the filter choke is placed in the negative plate supply lead, and the voltage drop across the choke is used as C bias for the control grid of the power tube. When the voltage drop across this choke is not correct for biasing purposes, a resistor is inserted between points *x* and *z* in Fig. 5, and the control-grid return lead of the power tube is run to point *x*, as indicated by the dotted line, instead of point *y*. The ohms value of the inserted resistor is so chosen that the voltage drop across the resistor equals the correct bias voltage for the tube. Notice that the cathode of the power tube is grounded, eliminating the need for a cathode bypass condenser and resistor. A decoupling resistor and condenser are required in the control-grid circuit of this tube, however.

A rather unique method sometimes used to secure a positive screen-grid voltage for the detector tube is shown in Fig. 6. Observe that here the detector screen-grid is connected directly to the cathode of the power tube, which is sufficiently positive with respect to the detector tube cathode for this purpose.

### FILTER CONDENSERS

**Filter Condenser Connections.** When the filter choke is in the positive side of the power pack circuit, all electrolytic condensers will have a common negative lead. When the filter choke is in the negative side of the circuit, however, the negative side of the input filter condenser does not connect to ground (chassis) and consequently requires a separate lead. In this case the 2 filter condensers may have a common positive lead, as is the case in Fig. 5.

Failure of filter condensers is quite a common occurrence in universal A.C.-D.C. receivers. Oftentimes there will be no markings whatsoever on the old condenser block to serve as a guide in ordering a new unit; in a case like this, the following method of reasoning will allow you to order a satisfactory replacement.

Make a sketch of the old condenser block, showing all leads which come out from it. Now trace each condenser lead and determine where it goes in the circuit. By this time you will be able to recognize the type of power pack circuit used. Label each lead on your sketch according to the point to which it connects, and indicate its polarity. Once you recognize the type of circuit used, you will have no difficulty in determining the polarity of any point with respect to the "B—" lead and in drawing the internal connections for the condenser sections. Condenser block sketches for the power pack circuits given previously in this article are shown in Fig. 7.

Here are a few tips towards identifying the various leads. If the filter choke is in the positive side of the power pack circuit, as evidenced by a direct connection from one of the choke terminals to the cathode or cathodes of the rectifier tube, then all of the filter condensers in the block will have a common negative lead. You can identify this common lead by the fact that it connects to the receiver side of the ON-OFF power switch either through the chassis or through a common lead. Once this is done, you can draw in the internal connections of the condenser block just as has been done in Fig. 7.

If the choke is in the negative side of the power pack circuit, as evidenced by the rectifier tube cathode tracing directly to the screen grid of the power tube without encountering any current-limiting or choking devices, you can locate the negative lead for the input filter condenser by the fact that it will be the only filter condenser lead connected to the switch side of the filter choke. Where the loudspeaker field coil gets its current from a separate section of the 25Z5 rectifier tube, there will be a condenser across the loudspeaker field coil with its negative lead also connected to the switch. In most cases a single common negative lead is used for both condensers. The positive leads for these condensers are easily identified: the positive lead of the loudspeaker filter condenser will go to that 25Z5 cathode to which the speaker field is also connected, while the positive lead of the input filter condenser will go to the other cathode of the rectifier tube.

Having located the leads and determined the functions of the various sections of the electrolytic filter condenser block, you are ready to place on your sketch the approximate capacity values for each section. Use the following general rules as your guide:

**Input Filter Condenser**—any value between 10 mf. and 20 mf., rated at 200 volts D.C. working voltage; **Output Filter Condenser**—any value between 8 mf. and 16 mf. rated at 200 volts D.C. working voltage; **Loudspeaker Field Coil Filter Condenser**—between 4 mf. and 8 mf., rated at 200 volts D.C. working voltage; **Cathode Bypass Condensers**—5 mf., rated at 25 or 35 volts D.C. working voltage.

While condensers smaller than the minimum values given should not be used, the maximum values may be exceeded without impairing the operating qualities of the receiver. The voltage ratings can likewise be higher than the minimum values given.

Your electrolytic condenser block sketch now gives you the necessary data for ordering a replacement unit. If a unit having the desired internal connections and desired capacities is not available, the next best thing is to order a condenser block having the desired capacities and separate leads for each section. If even this is not available, make up your condenser block from two or more separate electrolytic condenser units having the desired capacity and voltage ratings. When ordering separate units in this way, be sure to check the available space and choose units which are small enough to fit this space.

### JUSTIFIED COMPLAINTS

**Is the Customer's Complaint Justified?** The operating characteristics of a universal A.C.-D.C. or "cigar box" receiver of the T.R.F. variety must be carefully considered before attempting service work, in order to make sure that the customer's complaint is justified. These little receivers are designed primarily for reception of powerful local stations which are spaced well apart in the broadcast band. The receivers have little selectivity, so that local stations which are separated by less than 100 kc. may be expected to interfere with each other. The receivers likewise have poor sensitivity, and the reception of distant or even semi-distant stations will therefore be unreliable. Where the complaint of the customer simply involves one of these factors, no service problem exists. Likewise, good fidelity and freedom from blasting at full volume should not be expected from these receivers, particularly if they employ a magnetic-type loudspeaker. *The customer making complaints which involve these factors is asking too much of his receiver and requires a better receiver to meet his needs.*

**Common Troubles.** The simplicity of the circuits used in universal T.R.F. receivers greatly limits the variety of troubles which may develop. The complaints which will most often be encountered are: *Set is dead; local signals are weak; hum is excessive; set distorts; oscillation (squealing) exists; set operates intermittently.*

**Servicing "Dead" Receivers.** When the receiver is "dead," determine first of all if the tubes light or warm up. An open-circuit somewhere in the series filament circuit is indicated if they do not. Take out each tube in turn and check its filament prongs with an ohmmeter for continuity or test the tube in a conventional tube tester. If tubes are OK, check the filament voltage-dropping resistor with an ohmmeter. If a ballast tube is used for this purpose, inspect its socket connections in order to determine between which prongs there should be continuity. If a line cord resistor is used, check with an ohmmeter between the line cord resistor lead and each prong on the wall socket plug in turn (the plug being removed from its outlet); with the power switch open, or one tube removed, there should be continuity between one of the prongs on the wall plug and the receiver end of the line cord resistor if this resistor is OK. If there is a shunt resistor across the pilot lamp or lamps, check this with the ohmmeter for continuity. Check pilot lamps also for continuity.

If the set is dead but all tubes light up and test OK, use the D.C. voltmeter section of your multimeter to measure the voltage between the common rectifier-tube cathode connection and the tuning condenser frame (this always being at "B—" potential and convenient to reach with a test probe). With the set plugged into an A.C. outlet, you should measure between 90 and 120

Please Say That You Saw It in RADIO-CRAFT



volts, while with the set plugged into a D.C. outlet, this voltage may be as low as 85 volts. If no voltage is measured here on D.C., try reversing the position of the line plug; proper polarity must always be observed on D.C.

A low rectifier-tube output voltage on A.C. operation is an indication of defective filter condensers. Check each condenser or condenser section in turn, by disconnecting one of its leads and then checking the condenser for leakage with an ohmmeter. If leakage resistance is lower than the normal value for a condenser of similar size, the condenser is defective and requires replacement. Even if leakage resistance is normal (check the leakage resistance of a new condenser of about the same size for comparison if you are uncertain), the condenser may still have deteriorated through drying out of the electrolyte, with a resultant lowering of its capacity. Try a new filter condenser at each position in turn, while the old unit is disconnected. Separate 8-mf., 475-volt test condensers should be kept on hand for tests like this on any receiver. If the rectifier-tube output voltage comes up to normal when a new condenser is inserted, this is a sign that the old condenser was defective.

Even when only one section of the old electrolytic filter condenser is bad, a new block should be installed, for there is a good possibility that the other sections of the block will soon fail in a similar manner if left in the receiver. When using a test electrolytic condenser in this manner, you must, of course, observe polarity very carefully, for connecting an electrolytic condenser to a voltage source with improper polarity will in most cases ruin it.

If the rectifier tube output voltage of the "dead" receiver is normal, check the D.C. voltages between the "B—" point in the circuit and each plate and screen-grid prong of each tube. Repeat this test for the corresponding tube socket lug; failure of the two readings for any one tube electrode to correspond indicates a break between the lug and the tube socket prong connection, making the installation of a new socket necessary.

Improper voltages on any tube electrode will point to the source of trouble, just as in the case of an ordinary A.C. receiver. The circuit diagrams in this article will give you an idea as to what voltages to expect; obviously the detector tube plate voltage and the control-grid voltage on the power tube will be quite low due to the high values of resistance in these circuits.

Simple continuity checks of various receiver circuits often prove the speediest way of locating trouble in a "dead" receiver. There should be continuity between the rectifier-tube cathode and the plates, as well as screen-grids, of all other tubes in the receiver, with the exact ohmmeter reading depending upon the sizes of the resistors in the various circuits. There should be continuity from the receiver side of the ON-OFF power switch to the control-grids, as well as the cathodes, of all tubes in signal circuits.

Rotor and stator plates of tuning condensers are sometimes shorted together; inspection will often reveal such a short, but if doubt exists, disconnect the coil lead from the stator of each section and check each section individually with an ohmmeter. There should be no continuity between rotor and stator plates of a section.

To check the bias resistors in the cathode leads of the detector tube and the power tube, first disconnect the electrolytic cathode bypass condensers and then check the resistor with an ohmmeter. These condensers often have sufficient leakage to mask the effect of an open resistor. While making this test, check the leakage resistance of the bypass condenser with the ohmmeter.

Circuit disturbance tests on these receivers are limited to touching the control-grid caps with the finger or removing the caps, for pulling out a tube opens all filament circuits and masks the effect of the test. The above tests should result in location of the trouble in any "dead" universal-type receiver which uses a conventional T.R.F. circuit.

**ADDITIONAL DATA**

**Servicing Weak Receivers.** Essentially the same tests are made on a weak receiver as on a dead receiver. In addition, the dynamic loudspeaker field coil and its supply should be checked by applying a screwdriver to a pole piece; absence of pull indicates a defective field coil or no supply voltage to it. The continuity of the aerial should be checked with an ohmmeter, and the trimmer condensers should be readjusted for maximum output. Weak reception can often be cured by

moving the control-grid leads around enough to secure a small amount of regeneration.

It is a good idea to check the line voltage in the customer's home when weak reception is the complaint; if this voltage is below normal, report the matter to the local power company. Ordinarily there is nothing you can do to a receiver of this type to offset low line voltage. Excessively high line voltage is not serious in these small receivers, for the tube filaments and the pilot lamps are designed to stand up under all normal fluctuations in line voltage. With D.C. power lines particularly, the line voltage on peak loads may drop to a point where no reception is obtained, and again the trouble is not the fault of the receiver.

**Servicing Receivers for Hum.** A certain amount of hum is to be expected in any receiver operating from an A.C. line. Many Service Men forget this fundamental fact and spend hours trying to eliminate perfectly normal hum which they observe after correcting the original defect in the receiver. Hum should never be so loud, however, that it becomes annoying when listening to the program from a local station. Excessive hum is often caused by a reduction in capacity of filter condensers, by a heater-to-cathode short in some tube, by an improper connection of a filter condenser, or by an open control-grid return.

**Curing Distortion.** Improper centering of the loudspeaker voice coil is a common cause of distortion; the usual corrective methods apply here just as in larger receivers. Always try a new output tube when distortion is the complaint, for the great amount of heat dissipated by the heater in this tube often affects other electrodes in the tube.

A leaky coupling condenser between the detector and the grid of the output tube is another likely cause of distortion. If you can measure a D.C. voltage across the grid resistor of the output tube when the positive voltmeter probe is connected to the grid end of this resistor, a leaky coupling condenser is indicated; replace with a 0.05-mf., 600-volt cartridge condenser if you cannot determine the value of the original part. Check the ohms values of the cathode bias resistors, and check cathode bypass condensers for leakage in the manner already described, for these are also possible causes of distortion.

Distortion often occurs when the volume control is turned up too high when tuned to a strong local station; this is a normal condition due to overloading of the receiver stages or of the loudspeaker, and the remedy obviously is for the customer to keep the volume level below the point at which distortion begins.

**Curing Oscillation.** A certain amount of oscillation is to be expected in these midget receivers when the volume control is advanced to its maximum setting, for the designers of these sets depend to a certain extent upon regeneration for high gain. Oscillation at low volume control settings can be due to open bypass or filter condensers, as well as to failure to use tube shields if they were originally provided. Shielding of the control-grid leads of the R.F. and detector tubes, if these leads are over-exposed, or changing the positions of these leads are likely cures. Connecting the aerial to an external ground is sometimes effective in eliminating oscillations. Cramping the aerial into a small space will often cause circuit oscillation; keep this wire stretched out to its extreme length. As a last resort, when oscillation cannot be cured in any other way, detune the trimmer condensers until it ceases.

**Intermittent Reception.** Any of the usual causes of intermittent reception in radio receivers are to be expected in these midgets, but my experience has shown that in most cases either a defective type 43 output tube or a defective coupling condenser between this tube and the detector stage will cause intermittent trouble. Try a new output tube first of all, then try a new coupling condenser. If the trouble persists, wiggle each of the tubular condensers in the receiver in turn with your hand in an attempt to make the trouble appear. If this is not successful, resolder all connections in the receiver. If the volume control is noisy in its action, install a new control. Check the aerial with an ohmmeter while bending it slowly back and forth through its entire length, for this will sometimes reveal a break.

**General Suggestions.** Unless you are thoroughly familiar with the socket connections of the tubes used in these midget receivers, always have tube base layouts at hand for ready reference. These layouts are particularly helpful when making point-to-point voltage or resistance tests and when locating various parts in the receiver.

**SPECIAL OFFER**

a FREE three-month subscription to Sylvania News

SYLVANIA NEWS

OR A HAPPY NEW YEAR

HYGRADE SYLVANIA CORPORATION

55,000 live-wire radio men read each issue of Sylvania News\* . . . and letters keep pouring in telling us how helpful it is.

Join the ranks of the well-informed—get your free subscription to Sylvania News. In every issue you'll find—not only the latest news of the trade—but also a wealth of technical and servicing hints . . . practical merchandising ideas . . . tips on how to improve your business.

Mail the coupon below, and your three-month subscription will start with the very next issue.

\*The official "house magazine" of Hygrade Sylvania Corporation. Also makers of the famous Hygrade Lamp Bulbs.

See us at 204-06 Ampere Avenue, Nat'l Radio Trade Show, Hotel Stevens, Chicago.

**SYLVANIA**  
Set-Tested Radio Tubes

HYGRADE SYLVANIA CORPORATION  
Emporium, Pa. RC-78

Please send me Sylvania News for the next three months free.

Name .....

Address .....

City ..... State .....

Dealer  Service Man  
 Amateur  Experimenter

Name of Jobber .....

Please Say That You Saw It in RADIO-CRAFT

## A SURE-PROFIT FIELD for Alert Radio Men! HOME RADIO DIATHERMY



Hundreds of Radio Servicemen are now representing our Home Short wave diathermy line and acting as our agents in all parts of the country. We offer exclusive territory with absolute protection for all agents accepted by us. Our Short wave diathermy line is standard and has been definitely accepted as "fool-proof" by all who have made the most rigid tests possible on Diathermy equipment.

Our agents have averaged better than \$40.00 a week part-time. Full-time agents can easily do better. We show you how! Write for full particulars and details on making a real good income.

**SCIENTIFIC DIATHERMY CORP.**  
200 WEST 34th STREET - NEW YORK, N. Y.

Now!  
**BALLAST REPLACEMENT**  
made  
**AMAZINGLY SIMPLE!**

Only 4 standard types of Amperite AC-DC Regulators will replace 90% (over 100 types) of AC-DC Ballast Tubes now in use!  
**WRITE FOR CHART AR.**  
New Low Price \$1.00 List

**AMPERITE** AUTOMATIC REGULATORS  
561 BROADWAY, N. Y.

Make SILENT Motion Pictures into HOME TALKIES with **FILMOGRAPH**: Latest DUAL-PURPOSE Electro-Mechanical device for recording and reproducing Sound On Film as featured in MAY issue of RADIO-CRAFT. Records and reproduces instantaneously without processing VOICE, MUSIC, RADIO PROGRAMS, ETC. Sound tracks are mechanically impressed on the film and WILL NOT show on screen when projected. 80 minutes of recording cost 75 cents, including film. Guaranteed for 1 year. Patented.

Descriptive matter on request.  
Sole Manufacturers and Distributors  
**MILES REPRODUCER CO., Inc.** 812-8C B'way New York, N. Y.  
Cable Address: MILESMAN, N. Y.

**MODERNIZE YOUR OBSOLETE TUBE CHECKER OR SET ANALYZER with "PRECISION"**

Write for details. Mention make and model number of your old instrument.  
**PRECISION APPARATUS CORP.**  
1821 EAST NEW YORK AVE., BROOKLYN, N. Y.

Service shops need the **RADIO CHASSIS CRADLE!**

Service shops need the RADIO GIMBLE (chassis cradle) for efficient servicing, testing and repairing of receivers of amplifiers. Equipment clamps to cradle which can be adjusted to any angle. Accommodates chassis up to 13 x 12 x 2 1/2 inches. Excellent for displaying receivers. Write for illustrated circular RCI

WM. A. THOMAS CO., 321 Caroline St., Neenah, Wis.

## THE LATEST RADIO EQUIPMENT

(Continued from page 34)

### CABINET PATCH KIT (1636)

HERE'S a very handy complete kit of shellac patch sticks that will fill almost every demand. With this kit you can patch wood as well as the new plastic and bakelite radio cabinets, and white refrigerators. Simply heat the spatula on the alcohol lamp, and melt the shellac sticks into the nicks or scratches, and smooth off with fine steel wool or hot spatula. Apply a little polish and the job is done!

### SPECIAL PRODUCTS FOR TECHNICIANS (1637)

THE UNIQUE properties of several chemical products developed for use in the laboratories and factories of a well-known company are so interesting that they are being made available for general laboratory and other applications. As illustrated these materials include the following:

A metal etch solution, D, which provides means for printing permanent markings on brass, copper and silver, as well as for marking tube bases, etc. A safety etch paste, for frosting glass surfaces in 5 or 6 minutes (glass to be etched is first paraffined or lacquered and then cleaned off in the design to be frosted); an acid frost material, J, which affords convenient, rapid etching or frosting of glassware in from 10 to 15 seconds (may be used to produce a satin finish on glassware); glass etch material, I, that produces permanent white markings or monograms on glass; may be applied by rubber stamp and dries rapidly when heated.

A vacuum cement, A, which seals vacuum-furnace joints vacuum-tight; also may be used to seal joints between metal and glass surfaces; does not become brittle with age, and adheres to, almost any surface.

A fluorescent chalk, H, that glows in pitch-black darkness when illuminated by ultra-violet rays, appears white in daylight; used on a blackboard it may be made to fluoresce by using a sunlamp or a black-light bulb.

A stopcock grease, C, No. 6, for lubricating glass stopcocks which may be subjected to high temperatures while at the same time maintaining a vacuum-tight joint; stopcock grease, C, No. 7, is particularly adapted for use on stopcocks which are connected in high-vacuum exhaust systems; No. 8 is used in obtaining vacuum-tight joints and also in providing lubrication when rubber hose connections are made with the metal tips of vacuum exhaust pumps; No. 10 is recommended for general laboratory use at atmospheric pressure.

Glass marking ink (black), G, which may be used with a steel pen for applying letters to various glass surfaces; glass marking ink (white), B, also may be used with a steel pen for lettering glass; silver monogram ink, E, may be applied to glass surfaces by means of a rubber stamp; black monogram ink, F, which dries in about 2 minutes, also may be applied to glass or metal surfaces by means of a stamp.

### TWO NEW SPARK SUPPRESSORS (1638)

(Continental Carbon, Inc.)

TO ACCOMMODATE modern spark plug and distributor wire designs, 2 new designs in molded-bakelite, carbon-type spark suppressors have been announced. One unit (A, in photo) is a 5,000-ohm suppressor which snaps directly onto the ferruled brass stud of the spark plug.

### SERVICING QUESTIONS & ANSWERS

(Continued from page 35)

on the dial. How can this be corrected?  
(A.) Reception of 20-meter broadcast at both 14 mc. and 13.1 mc. is entirely in order. This second setting is due to image-frequency "interference." Response at 14 mc., however, should be far greater than that at 13.1 mc. In order to correct this difficulty, band D must be re-aligned. The correct method of aligning this band consists of "rocking" the tuning gang condenser with indicator set at 18 mc. and the signal generator tuned to this frequency, while adjusting the trimmer for this band for maximum output.

A resilient split collar of brass assures a firm connection. The ferruled nut on the suppressor is equivalent to that on the spark plug, but is removable to accommodate a spade connection.

The other unit (B) is a 10,000-ohm distributor suppressor with a special spring insert which assures firm contact with the spring clip on the ignition wire. The resistor element is molded in the bakelite shell of the suppressor.

### PLUG-IN METER RECTIFIERS (1639)

(The Triplett Electrical Instrument Co.)

ALL TESTERS that use one instrument to measure both D.C. and A.C. require a rectifier to change A.C. to D.C. The usual practice has been to build in copper-oxide rectifiers. Line surges, accidental misuse, etc., frequently cause burnout of the copper-oxide rectifier and this has heretofore required not only the problem of opening up, getting at and replacing the copper-oxide unit, but also recalibrating.

This new plug-in rectifier makes this problem as simple as renewing a burned-out fuse. The rectifier is mounted in a small plug with regular tube-base prongs. In the shell with the rectifier are the necessary calibrating resistors, making possible the interchangeable feature of the plug-in unit.

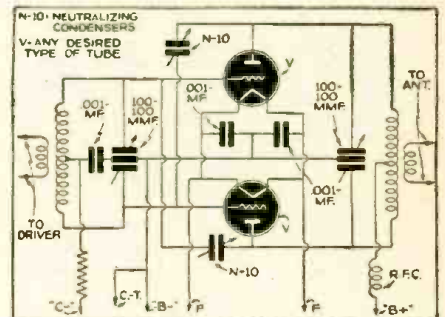

Schematic circuit of the Hammarlund unit-type amateur radio transmitter illustrated photographically and described on pg. 33. This factory pre-design of the assembly helps insure best results. (1623)

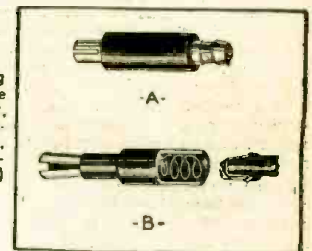

New spark plug resistors include a 5,000-ohm unit, A, and a 10,000-ohm suppressor, B, both of carbon type. (1638)

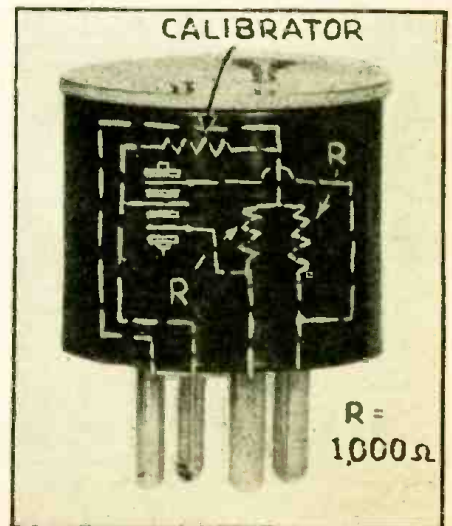

New plug-in meter rectifier eliminates the previously required recalibrating of resistors in the event of a burned-out copper-oxide unit. (1639)

Please Say That You Saw It in RADIO-CRAFT

## INTRODUCING—A 5-METER CONVERTER

(Continued from page 31)

(2) Experimental programs of several types, including special high-fidelity broadcasting on about 7 meters; and the audio channels of the ultra-high-frequency television stations, may be heard.

(3) It is also possible to "keep tabs" on programs the ordinary run of sets cannot tune in. Ultra-shortwave broadcast programs may be heard, with high-fidelity characteristics, when regular broadcast reception is at a standstill due to static.

The Kadette No. 210 converter is designed to convert any broadcast receiver—superheterodyne or tuned-radio-frequency—for reception of frequencies from 30 to 45 megacycles. The primary interest in this range lies in the broadcast band at 40 to 41 megacycles. Many of the regular stations in large cities are installing transmitters to operate in this newly assigned band. They feature programs of special interest with emphasis on educational programs, sporting events and special "from the scene" broadcasts. Many of the stations are entirely on a non-commercial basis with no advertising allowed on their programs.

These stations are practicable only in large cities, as transmitters on these ultra-high-frequencies, regardless of power, cannot cover a radius of much over 50 miles with the ground wave. The skip distance is so great that the sky wave will only be heard across the continent or in Europe. This means complete absence of interference between stations even though they operate on the same frequency and are only a few hundred miles apart. Atmospheric interference is much less noticeable on these frequencies. When there is more than one station in a city, they are required to operate on channels 40 kilocycles apart. This gives an opportunity for true high-fidelity broadcasts which are impossible on the regular broadcast band with only 10-kilocycle separation.

In addition to this broadcast band, the converter tunes many special government services and the 2-way police systems throughout the country.

The converter is easily installed and contains its own A.C.-D.C. power supply. A mixer circuit

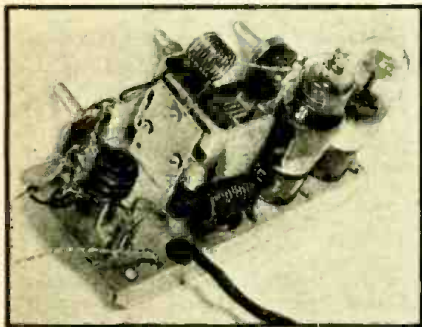

Figure B. This is the compact chassis of the 5-meter converter. It supplies its own operating power.

in the converter delivers an I.F. of just over 1,500 kilocycles, which is fed directly to the antenna of the broadcast receiver on which the dial is set to the above frequency. The converter has an on-off switch and a switch to convert the antenna directly to the broadcast receiver when the converter is not in use. This means that once hooked up the converter need never be touched.

### PLACING THE CONVERTER IN OPERATION

This converter is designed to be used in conjunction with any receiver, either superheterodyne or tuned-radio-frequency type, which tunes-in the standard broadcast band and frequencies up to 1,520 kilocycles.

Place the converter, preferably on a table, as close as possible to the receiver. If placed directly on receiver, microphonic noises may result.

To connect the converter to your receiver, first disconnect the antenna from the receiver. (If a ground is used leave it connected to the receiver as it is.) Then connect the white wire, of the twisted pair of wires at the back of the converter, to the antenna post of the receiver and the black wire of the pair to the ground post of the receiver. Finally connect the antenna to the green and white wire on the converter. Any antenna which gives good results with your present receiver will be satisfactory for both receiver and converter.

With the power cord of the converter plugged into a source of proper voltage supply, using a double outlet if necessary so that both converter and receiver are plugged in, the connections made as described above, and your receiver turned on, turn the left-hand knob on the converter clockwise. This switch turns on the power supply in the converter. Turn the right hand knob counter-clockwise to the position marked "S.W." This connects your antenna into the converter and your receiver to the converter.

**NOTE**—When this switch is turned to the clockwise (B.C.) position, your antenna is directly connected to your regular receiver and the converter disconnected so the receiver may be used for its regular tuning bands without changing any wires when the converter is not in use. When the converter is not in use, the power switch should also be turned off.

With the converter and receiver on and the switch in the "S.W." position, tune the receiver to about 1,520 kilocycles on the broadcast band. A hissing noise will be heard at this point and the receiver dial should be tuned to where this is loudest. Now tune the center knob of the converter for stations. Rotate the knob very slowly as stations on the ultra-high-frequencies tune very sharply. The converter should be tuned exactly "on" the station for best results. For a very fine tuning adjustment, the dial on your receiver may be shifted slightly. The dial is arbitrarily calibrated so that the figures do not correspond to actual frequencies of the stations. Volume can be controlled with the volume control on your receiver.

*Names of manufacturers will be supplied upon receipt of a stamped and self-addressed envelope.*

## THE FIRST 10 STEPS IN RADIO SERVICING

How do you go about servicing a set? One well-known radio engineer submits the following as the first 10 steps.

- (1) See that power supply to receiver is satisfactory. Check loudspeaker leads, antenna and ground connections.
- (2) Operate the set if possible. If trouble is not obvious, remove tubes and check them.
- (3) Touch the grid cap of I.F. tube or tubes with metal object, such as a screwdriver, and listen for click in speaker.
- (4) Check speaker transformer, voice coil and field, and make certain they are satisfactory.
- (5) Remove chassis and check power supply completely.
- (6) If power supply is OK, next measure all filament voltages, plate and screen-grid voltages, and bias voltages—compare with

specified values in circuit diagram or tube data book. If voltages on individual tubes are high or low, test components in the feed circuit.

- (7) Make certain that the audio circuit is functioning satisfactorily, then proceed to work from the detector to the antenna, one tube at a time, until the fault is located.
- (8) If no apparent troubles can be found, examine carefully all wiring, grounds, switch contacts, socket contacts and controls.
- (9) Use meters and check values of all components in inoperative section.
- (10) Check, clean and adjust all wave-change switches, and if necessary, clean dirty tie points which would otherwise cause low insulation resistance to ground. Clean insulation on gang condensers and resolder all weak connections in set. Replace noisy controls. Adjust alignment of receiver.

Please Say That You Saw It in RADIO-CRAFT



# TEN REASONS for specifying UTAH!

Here are ten good reasons why Utah Vibrators give better performance and last longer! Add to them the fact that Utah Vibrators cost no more and you'll know why an increasing number of Utah Vibrators are bought each year! Ask your jobber for Utah for all auto and farm radio sets!

- 1 Utah has pioneered practically every major improvement in vibrator construction!
- 2 Sulphur-free molded rubber liner eliminates chemical corrosion on metal parts—particularly contact points.
- 3 Rubber liner consists of two parts beveled to make a closer fit and suppress noise.
- 4 Lower liner molded to fit in order to hold mechanism in position in center of vibrator shield, supporting leads and preventing undue vibrations.
- 5 Exclusive flat frame provides simpler construction and more permanently rigid mounting for contact arms.
- 6 Short leads are clamped and held steady against vibrator frame eliminating vibration and preventing breakage of leads. Reduces radio interference usually resulting from long leads.
- 7 Tapered reed prevents undue strain and equalizes bending providing longer reed life.
- 8 Special design provides right degree of wiping action to keep pure tungsten contact points clean, but not enough to cause excessive wear.
- 9 Highest grade mica insulators.
- 10 Stack is held to frame with TWO screws making a mounting with less likelihood of misalignment.

Visit the Utah Booths 113-15 Marconi Blvd., Chicago Radio Parts Show, June 8 to 11!

**UTAH RADIO PRODUCTS CO.**  
CHICAGO, U. S. A.

CABLE ADDRESS - "UTARADIO" - CHICAGO  
BUENOS AIRES-UCOA RADIO PRODUCTS CO.  
"16 YEARS OF LEADERSHIP"

# A new way to EXTRA PROFITS with PYRO PANTAGRAPH

Size of box: 12 1/2" x 8 1/2"

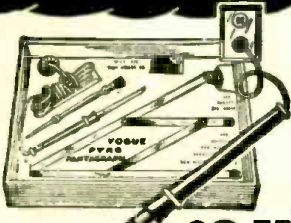

**\$2.75**

Shipping weight, 3 lbs.

With this PYRO PANTAGRAPH turn leisure time into profitable hours. Make money a novel, easy way—"Burn Your Way to Extra Dollars with Pyro Pantagraph."

This electrical outfit is especially designed for burning designs permanently on Leather, Wood, Cork, Gourds, Bakelite, etc. Simply plug the Pyro-electric pencil in any 110-volt AC or DC outlet and it is ready to be used. Plug and cord furnished as part of equipment.

By the use of a special Pantagraph included in the outfit, any design may be reproduced either in original, reduced or enlarged form. Outfit consists of: one Pyro-electric Pencil; one Pantagraph; three hardwood plagues; one bottle of Varnish; one Brush; one tracing tip and four-page instruction sheet.

Outfit will be forwarded by Express Collect if not sufficient postage included with your order.

**WELLWORTH TRADING CO.**

560 W. Washington Blvd., RC-738 Chicago, Ill.

## FREE TRIAL OFFER

NEW REMINGTON NOISELESS PORTABLE! AS LITTLE AS



**10¢ A DAY**

Famous Remington Noiseless Portable that speaks in a whisper. Pay as little as 10¢ a day. Guaranteed by the factory. Standard keyboard. Automatic ribbon reverse. Variable line spacer and all the conveniences of the finest portable ever built. PLUS the NOISELESS feature. Act now. Send coupon TODAY for details.

You don't RISK a Penny

We send you Remington Noiseless Portable for 10 days' free trial. If not satisfied, send it back. We pay all shipping charges.

Typing Course and Carrying Case

You will receive FREE a complete simplified home course in Touch Typing, a handsome sturdy carrying case is included. No obligation. Mail coupon for full details—NOW.

Remington Rand, Inc., Dept. 189-7,

465 Washington St., Buffalo, N.Y.

Tell me, without obligation, how to get a Free Trial of a new Remington Noiseless Portable, including Carrying Case and Free Typing Course for as little as 10¢ a day. Send Catalogue.

Name \_\_\_\_\_  
Address \_\_\_\_\_  
City \_\_\_\_\_ State \_\_\_\_\_

## PRACTICAL RADIO ENGINEERING

Don't "sit-down" on the job! Get busy and prepare yourself for the bigger jobs in store for technically trained men. CREI offers home-study training in both Radio Engineering and Service and Public Address work. A post card brings you our 48-page book of interesting facts about your future in Radio—and how we can help you prepare for it. Please indicate whether you are interested in Radio Engineering or Service.

SEND FOR FREE BOOKLET



**CAPITOL RADIO ENGINEERING INSTITUTE**

Dept. RC-7 14th & Park Road, N.W. WASHINGTON, D. C.

## "BI-FONIC" SOUND MAGNIFIER

(Continued from page 25)

### ACTION AT HIGH FREQUENCIES

Figure 2 shows graphically how the very high-frequency waves are reflected in whole off the half-round blocks. Some of the waves are reflected back through the cone and others reflected to another curved surface. To avoid confusion only 2 propagations of these waves are shown; actually, there are many hundreds.

At the very high frequencies, 2,000 to 10,000 cycles, the back-wave of the cone hits the set of curved surfaces directly in back of the cone. Because of these surfaces being curved some of the waves are projected through the cone; others are projected against the walls of the enclosure where they are further broken and weakened, thus creating a period of reverberation within the reproducer. The glaze or varnish on the curved surfaces determines the rate of this reverberation.

### ACTION AT MEDIUM FREQUENCIES

Figure 3 shows graphically how the frequencies are large enough to cover more than 1 half-round reflecting surface and are therefore broken into many parts. Some of the broken wave-reflections are reflected at such an angle as to be projected through the cone.

At the medium frequencies (200 to 2,000 cycles) the length and area of the curved surfaces are such that these waves are broken by the alternate vertical and horizontal strips on the back surface. The broken wave parts are projected against the side walls where their strength is further divided. At these frequencies the period of reverberation is less than half that of the extreme "highs." This avoids any cabinet resonance (which generally lies within this band of frequencies).

### ACTION AT LOW FREQUENCIES

Figure 4 shows the shell of the reproducer minus the reflecting half-round surfaces, since they are not in use at the low frequencies.

This figure shows how the wave is reflected from the large reflecting surfaces at the end of each of the tubes. And how they are finally projected into free air. The dotted lines represent the pressure or compression area of the wave-forms at any one instant. It is this pressure area which always stays on the same side of the envelope; but the wave envelope changes its form.

Note—The tubes are left out of the first preceding 2 figures (Figs. 2 and 3) because, at the frequencies pictured, the tubes play no part in the operation of the reproducer.

The low frequencies cannot be reflected by the surface in back of the cone because of the air pressure built up between the cone and the back surface at these frequencies. Therefore, they appear at the point of least resistance—the slot or "tube" between the back and the bottom surface. In this way the cone is automatically coupled to the mass of air contained in the 3 tubes at the low frequencies. The low-frequency wave projected into the first tube strikes the masonite bottom of the tube. Because of the pressure existing between the cone and the tube the wave again takes the path of least resistance and enters the mouth of the second tube. However, in being reflected from the masonite surface common to these tubes, the phase of the wave is inverted so the wave travels up tube No. 2 IN-PHASE with the front-wave component.

The same sequence takes place between tube No. 2 and tube No. 3, causing the wave to be projected down tube No. 3 OUT-OF-PHASE with the front-wave of the same component. Striking the inclined reflecting surface at the end of tube No. 3 the wave is projected into free air IN-PHASE with the front-wave. This has the effect of creating the equivalent of a reverberation period at the low frequencies. The length of the tubes and size of reflecting half-round surfaces are so chosen that frequencies high enough to cause half-wave cancellation are not projected into the tubes.

At the resonant frequency of the tubes the resonating wave is cancelled out within the tubes. This is due to the phase inversion taking place within the tubes.

As a result of these functions the cone is undamped at the high frequencies and at the very low frequencies the cone automatically sets a much larger body of air into motion, giving proper air displacement to the low notes. Also, and for the first time (to the knowledge of the

author), the back-wave is inverted and used at all frequencies.

The author has several of these reproducers in operation in New York City and vicinity, and the following results were noted:

All sense of music coming from a cabinet or diaphragm was lacking.

Bass notes were present in correct proportion at all volume levels.

Bass notes were not boomy but were solid and gave the foundation body so necessary to music balance.

For a given acoustic output about one-half the power was required that would be necessary with an infinite baffle.

In actual tests a 12-inch permanent-magnet cone mounted in a Bi-Fonic Reproducer housing out-performed an 18-inch electromagnetic-field dynamic cone mounted in an "infinite baffle." (See "Facts About the Infinite Baffle," Radio-Craft, May, '35; and, "How to Make An Infinite-Baffle, or High-Fidelity Speaker System," in the May, '37, issue, for additional, useful information on this general topic.—Editor)

### CONSTRUCTION NOTES

Note—The author warns anyone contemplating construction of one of these reproducers that the relation of the various dimensions and the flexibility of the various surfaces have a tremendous (Personal experience indicates that the adjective is well-chosen; in fact, we're tempted to prefix "tremendous" with "very"!—Editor) effect upon the proper operation of the reproducer.

A "standard" Bi-Fonic Reproducer (suitable for mounting cones from 8 to 12 inches in diameter) is shown in Fig. A. It stands 36 inches high, is 20 inches wide and 13 inches deep. It is constructed of 1/2-inch pine plywood and masonite. The half-round pieces are of spruce or cedar, and treated with several coats of bakelite varnish. The back is varnished and then coated with wax. The other surfaces are painted to prevent the absorption of moisture. All joints must be air tight and solidly made or they will break open and rattle.

By way of demonstrating, comparatively, to music critics just what the Bi-Fonic Reproducer could accomplish, a switching system was devised whereby a midget set's loudspeaker could be disconnected and an equivalent-size unit, in a Bi-Fonic housing, driven by the output of the same set. Immediately upon switching to the Bi-Fonic set-up the "highs" became more brilliant and louder, and the very-low notes became clearly and individually distinguishable; and timbre became a noticeable characteristic. (In order to deliver to the Bi-Fonic unit the very-low notes it was capable of reproducing, it was necessary to change the value of the coupling condenser, in the control-grid circuit of the output stage of the midget set being used for the demonstration, from 0.006-mf. to 0.05-mf.)

This, of course, is in accordance with the results, which engineers will appreciate at a glance, indicated by graphs A and B of Fig. 5. These curves were made at a commercial laboratory and clearly show the advantage (curve A) of a high-grade, 6-in. (3-lb.) permanent-magnet dynamic reproducer mounted in a Bi-Fonic housing, as compared to the same unit in an infinite-baffle housing of proper design.

Curve B of Fig. 5, however, is the one which will make the professional sound man look twice. It is "something to write home about," isn't it, to find a gain of anywhere from 3 to 10 decibels, straight across the board, from 40 cycles (the low-frequency cut-off point of the particular loudspeaker used) to 9,000 cycles (the high-frequency cut-off point of the speaker), over that obtained with a properly-designed infinite-baffle? The same 12-in., high-quality permanent-magnet dynamic reproducer was used in both instances.

### SUGGESTIONS TO RADIO AND SOUND MEN

The writer, for 4 1/2 years a studio-control engineer on the New York staff of one of the networks, has long been associated with the sound field; and was for 6 years a radio Service Man. As a result of this association he ventures to suggest to radio and P.A. men a few outlets for loudspeaker housings of this type which the technician will find profitable.

Please Say That You Saw It in RADIO-CRAFT

For instance, a very fine installation can be made, where the customer already has a fairly good radio set, by removing the loudspeaker from his present set and installing it in a Bi-Fonic Reproducer housing. This "trick" has the effect of making the set apparently more sensitive to weak signals, and at the same time almost doubles the effective power of the set; these things, aside from the increase in bass response and the consequent added depth of tone. (Invite prospective customers in to hear a set-up of this type in your display room or shop, if necessary.)

Another good sales-getter, and one which we have hinted at in the foregoing description, is to take a medium-size mantel set (such as illustrated in Fig. A), and connect the voice coil leads of its loudspeaker into the voice coil of a P.M. speaker installed in a Bi-Fonic housing. With this idea you can make very satisfactory remote-control jobs.

Public Address specialists will be interested to note that the Bi-Fonic Reproducer's field of application is practically unlimited; the unit's response is uni-directional over an angle of about 120 deg., and is most effective in the very low and very high frequency range (and hence is not suitable to apply in those cases where a high directional quality is wanted and only the speaking voice is to be used, as a horn or projector),

but where music is to be reproduced and wide-angle radiation is desired, it is unbeatable, either indoors or outdoors. It is exceptionally suitable as a broadcast-studio monitor speaker. Here are a few ideas, for your consideration, concerning the application of "Bi-Fonics":

Churches, Lodges, Clubs, Theater Sound Systems, Doctors' and Dentists' Offices (waiting rooms), Schools (auditoriums), Parks (summer-time municipal park concerts), Restaurants.

Because of the increase in the efficiency (more efficient loading) of a cone mounted in a Bi-Fonic Reproducer housing, about 1/2 the power is needed to produce the same loudness as a cone in an infinite-baffle. As a result, you can use lower power for the same degree of intensity, and in most cases, use class A amplification (with its inherent lower degree of total harmonic distortion) instead of A-prime or B.

In conclusion the author desires to emphasize the following points:

- (1) The back-wave is utilized at all frequencies;
- (2) There is no noticeable resonant point;
- (3) Bass cut-off is limited only to the cut-off characteristics of the speaker unit;
- (4) In addition to greater air displacement at the lower frequencies, cone efficiency is raised over 3 db. in the middle register, over 5 db. in the extreme high register, and from 5 to 10 db. in the bass register!

## MATCHING LOUDSPEAKERS TO TAPPED TRANSFORMERS

(Continued from page 27)

Since the impedance of the primary, as measured, is 20,000 ohms, the actual Z the tube plate will encounter is the result of these two in parallel or 4,770, which is a mighty fine load for an average power tube.

But how about the secondary? We've just finished telling you that there is no power drawn from a pure inductance, and that the impedance mismatch as indicated by the ohm value means nothing in this case. In a tube, yes, Rp is honest-to-goodness resistance in ohms, and you must match to it; across an inductive secondary, no.

How about fidelity? Who ever said that if you have an inductance across which appears some power which is to be used by a load, across it, the load must be twice anything for maximum fidelity? That, my friends, is true for a tube, in the primary only, and indeed here we have taken it into consideration, but found we'd rather have power output than fidelity. But, frequency response in the secondary, as far as "highs" are concerned, depends on the inductance and distributed capacity of the secondary, not on the load. In a properly-designed transformer, these are well designed, and the "highs" will come through quite well. As for "lows," that depends on the way the primary looks to the Rp, not on the load on the secondary and its relation to Zs. These mistaken notions are prevalent, but very unfortunate. There are a few other considerations which determine the frequency response obtainable in this arrangement, such as saturation, efficiency of transformation, etc., but the load on the secondary affects it only as far as its reflected impedance goes, and thus we see the importance of this reflected impedance in spite of the very little attention given it.

### MULTI-SECONDARY TRANSFORMERS

And by the way, don't think that the methods outlined are applicable to tapped secondaries only. They work equally well with multi-secondary transformers. For instance, suppose we want a set-up using two dynamics, 8 ohms, 4 watts; one at 8 ohms, 5 watts, and to bolster up the "highs" as much as possible, we will use a magnetic speaker of 2,000 ohms impedance on another winding. This arrangement is shown below: (See Fig. 1C.) The impedance we want reflected must be 5,000 ohms.

- Z-1 equals two 8-ohms impedances in parallel, or 4 ohms, 8 watts;
- Z-2, 8 ohms, 5 watts;
- Z-3, 2,000 ohms, 1/4-watt.

What are to be impedances of the secondary taps Za, b, c?

Using method 1, because this is the author's pet:

- Za equals 8/13.25 x 4 or 2.418 ohms.
- Zb equals 5/13.25 x 8, or 3.02 ohms.
- Z3 equals .25/13.25 x 2,000, or 37.8 ohms.

And check:

- Zra equals 4/2.42 x 5,000, or 8,200.
- Zrb equals 8/3.02 x 5,000, or 13,250.
- Zrc equals 2,000/37.8 x 5,000, or 264,200.

Putting these in parallel, because that's how they look to the tube output, we obtain 4,980, which is close enough.

It is worthy of notice that the impedance that a load reflects into the primary is a function of the ratio it bears to the impedance of the secondary tap from which it is supplied. Thus, in the extremes, if the load is infinite, the reflected Z is infinite, because infinity divided by any number, except infinity (which is not a number at all, but a concept) is infinity. If the load has 0 ohms impedance, theoretically on short-circuit, the reflected impedance is also 0 ohms, or the theoretical short-circuit, because 0 divided by any number, although mathematically speaking imaginary, is in actual practice, 0. If you have a month's spare time, look into the mathematics of this.

### SERIES VS. PARALLEL CONNECTION

One more point deserves mention. Why not put the two speakers in this problem, or the speakers in the first illustration, in series, instead of parallel? Quite feasible. Thus in the problem cited, the diagram would look as follows: (See Fig. 1D.)

Only the upper tap is altered, the others remain just as they were. Now the load Z is 16 ohms, still 8 watts, and, applying our rules, Za equals 9.68 ohms. Since 16 is to 9.68 exactly as 4 is to 2.42, the reflected Z is the same, and, apparently, the problem is unaltered.

But, suppose now one of these two speakers is removed, either because unnecessary, or, due to failure in operation. In the series arrangement, this opens the load on Za, and the whole kaboodle is thrown out of balance. How much? Well, if it fails in operation, the remaining reflected impedance is now 11,200, hence the tube output is materially decreased, and other speakers will suffer. If it is removed, and the one is connected across the whole winding, it will be overloaded slightly, to begin with, and the reflected Z will be 3,120, slightly overloading the tube and really disrupting the balance of the whole arrangement.

In the parallel arrangement, if one fails or is removed, the total reflected impedance will be 6,700, which will not upset the arrangement enough to cause worry. Moreover, the remaining speaker will not be overloaded. In practice, there is little advantage in connecting them in series, and the parallel connection is most commonly used.

It is hoped that the above discussion, in which test cases were used as examples, will be useful as a practical reference on the subject.

Please Say That You Saw It in RADIO-CRAFT

## For Both A. C. and D. C. Testing

Use  
MODEL 666



Dealer Price \$15.00

Pocket Volt-Ohm  
Milliammeter

Has 3" Sq. Triplett Improved Rectifier Type Instrument.  
AC-DC Voltage Scales Read: 10-50-250-500-1000 at 1000 Ohms per Volt.  
D.C. Milliampere Scale Reads: 1-10-50-250.  
Ohms Scales Read: Low 1/2-300; High 250,000.

Size—3-1/16" x 5-7/8" x 2-1/8".  
Black Molded Case and Panel.  
Low Loss Selector Switch.  
Complete with Alligator Clips, Battery and Test Leads.

DEALER PRICE . . . . \$15.00

A complete instrument for all servicing and other needs. Can be used for a l A.C.-D.C. voltage, current and resistance analysis. Resistance range can be increased by adding external batteries.

Attractive, Heavy Black Leather Carrying Case with Finished Edges and Strap, Model 669, supplied extra.

DEALER PRICE . . . . \$3.67

WRITE FOR CATALOG

SEE THE NEW TRIPLETT 1938-1939 LINE AT THE CHICAGO JUNE RADIO PARTS SHOW BOOTH 213-15—Henry Avenue



The Triplet Electrical Instrument Co.  
167 Harmon Drive, Bluffton, Ohio

—Please send me more information on Model 666; —I am also interested in:

Name .....

Address .....

City ..... State .....

## UNIFIED P.A. EQUIPMENT

(Continued from page 28)

all normal work, equipment properly chosen will perform correctly the first time tried. Common apparatus is built with sufficient versatility to meet normal variations in requirements, and specialized models are available at reasonable cost because even special jobs are now relatively common.

Further, much time was wasted in the past, when P.A. systems had to be bought as so many individual components, in the mere low-pay work of connecting up cables, attaching plugs and similar unprofitable activities. Such practices are now unbusinesslike. The P.A. man economizes his high-pay time in surveying jobs, contacting his customers, and other business activities, and leaves attaching plugs and the like to the factory production line, where they belong.

### PRIMITIVE AND MODERN METHODS

The full extent of the difference between what may be called the "primitive" and the "advanced" methods of handling technical and business problems in P.A. can best be appreciated by considering two practical P.A. jobs, both treated first according to the old and then according to current methods. Two jobs must be taken into account instead of one, since the versatility of modern apparatus is one of its prime advantages.

Consider that the first requires only a microphone and, say, 10 or 12 watts power, with 2 loudspeakers; the second, 2 microphones (1 remotely located), a phonograph pickup, 30 watts power and 4 speakers.

Under the old dispensation the P.A. man removes the system from rental job No. 1 and considers what parts of it he can salvage for rental No. 2. Assuming that the amplifier had enough reserve power, he might use all of it. He would then need, in addition, a pre-amplifier for the second microphone, a mixer for the three sound sources, and a matching transformer or transformers for the 2 speakers already used, to enable them to work with 2 additional speakers from the same output impedance. Having equipped himself with these assorted parts he might spend from 2 to 10 hours wiring them up to the appropriate cables, testing them out, grounding them here and there to cut down hum, taking some of the grounds off again and connecting them in different locations to avoid electrical feedback, and generally, impressing his customer with the idea that P.A. is a very nice plaything, and may become practical some day.

Today, removing his equipment from job No. 1 (and again assuming that the amplifier has sufficient reserve output, which is now very inexpensive) he merely plugs in his additional microphone and phonograph. His amplifier will have enough gain: no preamplifiers needed; and the mixer will be built-in. He will plug-in (or possibly, in this case, connect by cable) 2 additional loudspeakers. To match impedances he consults his manufacturer's instruction sheet and changes a tap or pin-jack connection in the amplifier, thus obtaining a new output impedance to match the new load combination. Grounding for hum or electrical feedback was taken care of in the factory. Time spent is a half-hour at the most; if his equipment is really modern, probably less than 10 minutes.

### PRESENT EQUIPMENT COMPACT AND ATTRACTIVE

The illustration shows modern equipment, in this case, a Lafayette coordinated sound system, which combines within itself all the functions of the mass of earlier appliances included in the contrasting picture of primitive apparatus. The present day equipment performs the functions of:

- Pre-amplification for two channels
- 4-channel mixer
- Power supply to photoelectric cell, microphone or other input source
- Power supply for loudspeaker fields
- Booster amplifier, for 132 db. gain
- Speaker line multiple impedance matching transformer.

The same functions in earlier days (uncertainly performed because of external wiring, doubtful shielding, and so on) would have required:

- 2 preamplifiers
- 1 mixer
- 1 booster amplifier

- 1 microphone power supply unit
  - 1 speaker field power supply unit
  - 1 speaker line matching transformer
- or a total of 7 additional pieces of apparatus, to be wired together on the job and to clutter the customer's premises.

Eye appeal is one vital business factor in modern P.A. work, now that P.A. is really a business and the customer's premises are no longer treated as a laboratory, to be supplied with assorted chunks of black apparatus. Streamlining, chrome, aluminum or cadmium trimmings, illuminated controls and attractive color combinations are some of the features manufacturers now offer the P.A. merchant, and which he in turn passes on to his customers. They are factors that he uses in meeting competition, and their cost is insignificant while their value is very large. The renter or user is impressed with the fact that he is receiving a finished product—an article of merchandise—a machine that can logically be prettied up because it has passed its pioneering days and is a standardized, definitely useful article. The cost is trifling because all such costs are trifling when a market is large enough to permit production-line manufacture.

### PRESENT-DAY PROCEDURE

Business-like procedure is another way in which the present-day P.A. merchant meets competition, not merely through its economy but because of the favorable impression such procedure leaves in the mind of the potential buyer. In sizing up a given P.A. job, the first factor to be considered is almost always the power output required. The cost and type of amplifier to be used is thus established. Given a normal problem and a modern system, the same data also ends all speaker questions, since a modern system of the given power rating will carry with it the correct number of speakers, correctly matched and properly baffled, for any ordinary indoor or outdoor application requiring that amount of power. Only in special cases will it be necessary to return to the older method of determining individual speaker requirements in the field, and of calculating speaker impedance and field power matching problems.

Selection of the microphone is, however, somewhat more complicated because of the still wide variety of microphone needs, and for that reason P.A. systems are often sold today with choice of microphones. The Lafayette system referred to above is available with crystal, velocity or dynamic microphones, directional or non-directional. The directional microphone is of course desirable where acoustic feedback may prove difficult and where other considerations of the service to be performed permit its use. Another point worth remembering in the case of microphones is that where the performer is featured, he (and especially she) prefers a small instrument, which will not hide his or her face from the audience. But there is no microphone matching problem; all the many types of microphones that are offered optionally with a modern system simply plug in.

It will be seen that the field engineering problems of ordinary P.A. work have been simplified to the point where setting equipment for demonstration presents no difficulty and little delay, providing only that the power output has been estimated correctly for the requirements, and that modern coordinated equipment is used.

### ADVANCED CIRCUIT ADVANTAGES

A large part of this seeming simplicity is in fact based on highly complex engineering, through which technical problems that formerly obtruded themselves in the field, and disgusted the customers, are now taken care of in the factory design. A highly important factor in this connection is *acoustic distortion*, which often required elaborate experiment with speaker positions. Nothing that can be done with a sound system will change the acoustics characteristics of an enclosure, but it is very possible to use individual bass and treble tone controls to compensate for defects in a building and so to produce pleasing sound where straight-line amplification over all frequencies might sound unnatural. As long as the straight-line-amplification characteristic is present and can be used, when conditions favor it, the listener is the gainer by the further existence of H.F. and

FREE

GREAT  
RADIO AND  
CAMERA  
CATALOG



FREE!  
SEND FOR  
IT NOW

Send for this FREE catalog today. Page after page of money saving values in Lafayette Radios—"Ham" equipment—Public Address—parts and tubes.

**NEW CAMERA SECTION**  
Features a complete line of cameras and photographic supplies. Make this your buying guide. Send for your FREE copy of Catalog No. 71-3G8.

**WHOLESALE RADIO SERVICE CO. INC.**  
103 Sixth Avenue • New York, N. Y.

### 6-VOLT UNIVERSAL POWER PACK

At Less Than Price of Prong Synchronous Vibrator Alone!

LISTS \$15.00



Operates 2 volt set from 6 volt storage battery, also operates 6 Volt house sets, auto sets, S.W. transmitters and receivers. Output, 180 Volts at 50 M.A. On 4 Volt cell supplies 120 Volts at 30 M.A. Housed in case 3" x 4" x 6". Ship. ONLY \$3.95. Ping Wt. 6 lbs.

ARROW SALES COMPANY

27 S. Jefferson St.

Chicago, Ill.

WHEN YOU THINK OF

AMPLIFIERS

REMEMBER TO LEAD FOR THE FREE 1938 P.A. CATALOG

of Amplifiers Designed by A. C. Shaver

AMPLIFIER CO. OF AMERICA

37-47 West 20th St., New York, N. Y.

## RADIO ENGINEERING



RCA Institutes offer an intensive course of high standard embracing all phases of Radio and Television. Practical training with modern equipment at New York and Chicago schools. Also specialized courses and Home Study Courses under "No obligation" plan. Catalog Dept. RT-38.

### RCA INSTITUTES, Inc.

A Radio Corporation of America Service  
78 Varick St., New York 1154 Merchandise Mart, Chicago

HAVE YOU SOMETHING TO "SWAP"

or is there some article that some one else has, and you would like to get? Read the RADIO-CRAFT "SWAP SECTION" which appears on page 62 of this issue. IT IS OF GREAT INTEREST TO YOU.

Complete Electric Plants



Gnan A. C. plants furnish same current as city lines. 110 Volt, 60 Cycle. For farms, camps, construction jobs. Operate radios, water systems, all appliances. New models, 350 to 5000 watts, 6, 12, 22 and 110 volt D.C. Models \$37.50 and up. Also combination A. C. - D. C. units. Shipped complete, ready to run.

Write for details.

D. W. GNAN & SONS  
867 Royalston Ave., Minneapolis, Minnesota

RADIO MATHEMATICS

Practical Book for Home Study

Complete training in useful radio mathematics. Explains and interconnects simplified arithmetic and algebra with real everyday radio problems. Covers in detail every phase of radio work. Size: 8 1/2 x 11 in. Special price, only 50c, postfree.

SUPREME PUBLICATIONS

3729 W. 13th St. Chicago, Ill.

YOU NEED ALL 8

Rider

MANUALS

JOHN F. RIDER, PUBLISHER  
404-4 th Ave., New York City

L.F. controls that combine with acoustical response to produce a straight-line result at the listener's ear.

Reverse feedback is still another modern feature, saving the P.A. man the necessity for apologizing for distortion inherent in his amplifier, if the customer should ask to "Hear how it sounds if you make it a little louder."

Having sold his customer, the P.A. merchant delivers a complete article, with (as before mentioned) plugs attached to cables, cables attached to microphones and speakers, and so on—in fact, with everything ready to use in 5 minutes, except that because of shipping problems the baffles must be mounted in the field.

Those Public Address merchants who keep themselves fully in step with such advanced procedure are the ones that find P.A. a business and a profitable one; but unfortunately there is still a little work, here and there, that is being done according to the very earliest practice, and some at all stages in between. There are still today some "complete" systems, advertised and sold as complete, which are without baffles. Step-by-step, however, the industry has progressed along the logical line of concentrating all problems of selecting parts, and of matching and inter-wiring them, in the hands of the factory engineer, leaving the P.A. man in the

field free to concentrate on his logical problem of merchandising a unified, finished and polished article of customer appeal.

The illustration shows the functioning of one of the modern, business-like systems. Four-position mixer, preamplifier, individual high-frequency and low-frequency compensating controls, field power supply, microphone or photocell excitation supply and speaker line matching transformer are all built into the amplifier itself. Connections to the speakers and the microphone or other sources of sound is by plug-and-jack method. Reverse feedback eliminates harmonic distortion at high volume levels. Convenience in the field is promoted by the fact that the system leaves the factory as a single unit, tested as a unified assemblage with all parts connected and working together. Modern styling, enhanced by the fully ventilated cover case that hides all working parts, by the convenient handles at both top and sides, the self-glowing neo-dials of the controls and similar details, makes for a professional, finished appearance that removes from the buyer's mind the idea of laboratories and experiments, and substitutes the idea of merchandise of value.

This article has been prepared from data supplied by courtesy of Wholesale Radio Service Company.

## A WIRED-RADIO "NURSEMAID"

(Continued from page 38)

If it is found difficult to trace the wiring of the fuse box, simply try the condenser under various pairs of fuses until you find a combination that properly couples the 220 V. circuit, or until a combination is obtained which produces satisfactory operation of the Radio Nurse. This condenser is fully protected by its internal fuse, and even if improperly installed will cause no difficulty whatsoever from short-circuits, etc.

### IMPORTANT INFORMATION

If the Radio Nurse Lacks Sensitivity: The Radio Nurse is designed to operate under normal home conditions. When it is operated in a commercial establishment, lack of sensitivity may result due to heavy light loads, heavy power loads, high line capacities, split wiring circuits and heavily bypassed or filtered wiring commonly used to reduce line disturbances in radio receivers. The Radio Nurse being a radio-frequency-operated device depends on freedom of loads or capacity on the line which factors partially or completely bypass the signal. To overcome this condition and obtain proper efficiency from the Radio Nurse in commercial installations, the various factors must be eliminated. If, however, this is not possible, then an isolated power line must be used. Isolation can be accomplished by placing an R.F. choke in each 110-volt lead of the wall outlet, and running the 110-volt leads from the chokes to both the Guardian Ear and the Radio Nurse direct. Do not determine that the Radio Nurse lacks sen-

sitivity unless such isolation has been made, and the units separated far enough, and well isolated by separate closed rooms to avoid howl with the volume control set at maximum.

Interference from A.C.-D.C. receivers. Due to the type of circuit, and rectification system employed in A.C.-D.C. receivers, they may cause loud interference in the form of a hum to be heard in the Radio Nurse. This can be overcome by connecting a filter at the socket to which the A.C.-D.C. receiver is attached. A soldering iron or curling iron may also cause this interference in which case the same filter units may be applied to the interfering device.

Names of manufacturers will be supplied upon receipt of a stamped and self-addressed envelope.

## HUM IN PUBLIC ADDRESS INSTALLATIONS

With the introduction of the bass reflex speaker and its consequent improved low-frequency reproduction, the question of hum in Public Address installations is becoming of greater importance.

The manufacturer of sound equipment in this respect needs very keenly the assistance of the installation organization to the end that the installation should be properly made.

It is very important with the low-level microphones that are now being used, that the continuity of the shielding be perfect. In other words, even a break as small as 1 inch in the microphone wire shielding will introduce a serious amount of induction pick-up in the system.

The amplifier should be grounded to eliminate the floating chassis condition. The selection of the proper type of tubes is also important. It is an unfortunate matter that many of the radio tubes available on the market today, while ideally suited for use in radio equipment, are of too noisy a character for general Public Address work. The construction of the tube heater structure has much to do with the amount of hum that will be generated by the amplifier. It is a fortunate fact that the manufacturers of tubes are appreciating more and more the importance of humless tubes for public address work and to this end a number of manufacturers have worked very closely with Webster-Chicago to supply tubes particularly adapted to audio applications. It is to be hoped that in the future tubes will be available with some type of designation marked thereon indicating that they have been picked or selected for high-gain audio work.

On some of the smaller light plants, where the waveform is not particularly good and the power supply contains harmonics of the order of the 17th, 19th, etc., inductive sing becomes a problem that requires close attention to input shielding and grounding.

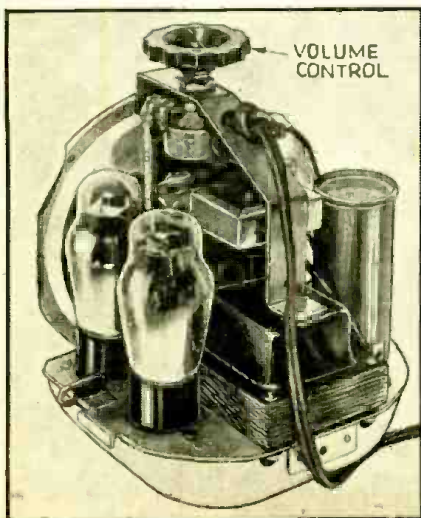

Fig. 8. Interior view of the "Radio Nurse" or loudspeaker unit. This is an upside-down position, since the volume control operates from below.

# MAKE MORE MONEY in RADIO

## SPRAYBERRY'S PERSONAL HOME TRAINING PLAN

Actually Sets You Up For a PROFITABLE BUSINESS

Be Your Own Boss! Get into the fast moving Radio industry. If you are an ambitious fellow, I can train you for a good paying full time or part time job with a big future ahead. My training is distinctly new and different.

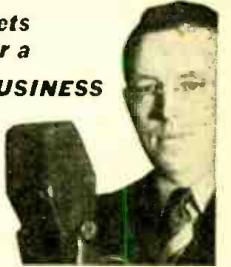

Television Covered... Earn While You Learn

Sprayberry Training not only covers thoroughly all phases and branches of Radio... It equips you for an actual start in business. I show you how to get profitable spare time Radio service work. Moreover, I show you how to do these jobs. You gain practical experience... add easy cash to your bank account while learning.

**BIG PROFESSIONAL OUTFIT GIVEN!** Consists of All-Wave, All-Purpose Analyzer, Rider Manuals (7,076 pages), Tool Kit, Electric Eye Outfit, Experimental Apparatus. THE SPRAYBERRY COURSE IS SOLD UNDER AN IRON-CLAD MONEY-BACK AGREEMENT. A. H. Lanole, Northbridge, Mass., writes: "Since enrolling I have cleared a net profit of more than \$150. in spare time alone... and I am not half through the course yet. Honestly, I cannot understand how you give so much dope for so little money."

**SPECIAL SERVICEMAN'S COURSE** Advanced Training for those already in Radio—teaches the easiest way to do the hardest jobs. Complete details of this advanced course and fundamental course, features, etc., fully described in my 48 page FREE book. Send for your copy today.

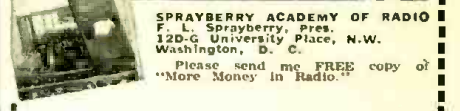

**Mail Coupon Now**

SPRAYBERRY ACADEMY OF RADIO  
F. L. Sprayberry, Pres.  
120-G University Place, N.W.  
Washington, D. C.

Please send me FREE copy of "More Money in Radio."

Name ..... Age .....

Address .....

City ..... State .....

Mail in envelope or paste coupon on postcard.

**Answers YOUR Questions**

**DREW'S**

**HOW TO PASS**

**Radio License Examinations**

By CHARLES E. DREW, I.R.E., A.I.E.E.

This book is more than just a new edition of a famous work. It has been completely rewritten, and will serve as an excellent guide to all radiomen. Important phases of the subject are given thorough treatment, so that the man who understands the content of this book will be well qualified to pass the examination for his commercial license.

Published March 1938 \$2.00

**ON APPROVAL COUPON**

John Wiley & Sons, Inc.  
440 Fourth Avenue, New York, N.Y.

Kindly send me a copy of Drew's HOW TO PASS, on ten days' approval. If I decide to keep it, I will remit \$2.00; otherwise I will return the book postpaid.

Name .....

Address .....

City and State .....

Employed by .....

R.C. 7-38

Please Say That You Saw It in RADIO-CRAFT

**G.E. PHONOGRAPH MOTOR**

Formerly Sold for \$15.00

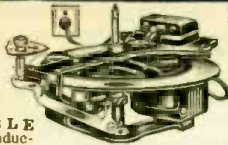

Only \$4.95

**VARIABLE** speed induction type self-starting, 110 volt, 25 to 60 cycle, A.C. with speed control. Plug and cord. Speed range from 5 to 200 R.P.M. Can be installed in place of old-fashioned, hand-winding speed motor. Also ideal for display turn table, and a hundred other uses. These General Electric Motors are brand new, in original factory cartons. **\$4.95**

G. E. Electric Phonograph motor as described Shipping Weight—12 lbs.

**WESTINGHOUSE UNIVERSAL MOTOR**

**\$2.55**

110 Volts AC and DC

Shipping Weight 3 lbs.

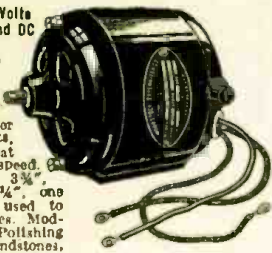

Specifications: 1/30 H.P. operates on either A.C. or D.C., 110 volts, 5000 R.P.M. Rheostat can be used to vary speed. Height 3 1/2", Length 3 3/4", Width 1 1/2", Shaft 1/4", one inch long. Can be used to drive Sewing Machines, Models, Boring Lathes, Polishing Head, Drills, Grindstones, etc., etc.

MOTOR only \$2.55

MOTOR with Arbor and 1/4" Chuck \$3.55

Add 25c for special packing and mailing anywhere in U. S. A.

We will forward Shipments by Express Collect if sufficient postage is not included.

**WELLWORTH TRADING COMPANY**  
560-W. Washington Blvd., Dept. RC-738, Chicago, Ill.

**300 WAYS TO MAKE MONEY**

**SPECIAL INTRODUCTORY OFFER**

Good Only For A Short Time

**10¢**

PER COPY

68 PAGES



A Brand New Book 1938 Copyright

In "CASH IN" you will find all the real money-makers — dozens of profitable tested mail order plans, confidential business

secrets, dozens of practical tested formulas, successful, and honest tested schemes — many actual experiences of men who have started on the proverbial shoestring — with less than \$10 capital.

"CASH IN" contains 68 pages of tested ideas covering every type of full- or spare-time enterprise — it is really a "masterpiece" in business ventures — OVER 40,000 WORDS IN THE TEXT.

Special introductory offer — 10 CENTS per copy. (Regular price 25c.) Sent POSTPAID anywhere in U. S. upon receipt of ten cents in stamps or coin.

**NATIONAL PLANS INSTITUTE**  
246R FIFTH AVENUE NEW YORK, N. Y.

**RADIO IN IT S ENTIRETY!**

"B-A" serves the trade with every need in radio — complete 160-page catalog of nationally known radio receivers, public address, parts, supplies and equipment. Orders shipped same day received.

**COMPLETE CATALOG AVAILABLE**

**BURSTEIN-APPLEBEE CO.** 1012-14 McDEE ST. KANSAS CITY, MO.



**WAX AND OIL CONDENSERS IN RADIO SERVICE WORK**

(Continued from page 28)

voltage is applied before the heaters have come up to full values of current and voltage.

**CAPACITY AND VOLTAGE CONSIDERATIONS**

In the replacing of wax- or oil-impregnated paper "capacitors"—as they are known today to the trade—the Service Man is concerned with capacity, working voltage, test voltage, capacity tolerance, inductive or non-inductive sections, power factor, size and price. Many manufacturers do not pay close enough attention to capacity tolerance, and mark units anywhere from 25 to 30% from their actual capacity values.

The actual capacity marking should be carefully checked by the Service Man before final replacement is made in the set. After locating and repairing the trouble, the Service Man can check against the rating of the new condenser, if the condenser is one where the capacity value is at all critical. This applies especially to the smaller-type condensers which are used in oscillator circuits. If the capacities are not of the proper value, the oscillator will not properly operate as originally intended by the set manufacturer.

**CHECKING FOR "WAX" OR "OIL"**

When selecting the proper working voltage at which the units are to be operated, the Service Man should take into consideration the likely possibility of transients causing high peak voltages due to line surges and other faults beyond the control of the usual operation of radio receiving equipment.

In the manufacture of wax- and oil-impregnated condensers, each unit is originally flashed for from 3 to 5 seconds at twice the working voltage. A representative unit of each group manufactured is placed on life test at 3 times the rated voltage with a 10% superimposed A.C. voltage. These conservative ratings of condensers by reputable manufacturers assure Service Men freedom from future breakdown provided they are used when replacements are made in a radio receiver.

The choice of inductive or non-inductive sections for replacement work can easily and quickly be chosen by careful observation of the unit which has failed in service. A non-inductive section is usually wound with an extending margin of foil on either side of the paper or dielectric. The inductive type of winding appears with paper extending beyond the foil, with tabs as connectors.

**POWER FACTOR**

The power factor of a wax- or oil-impregnated condenser is often of vital importance. It is a measure of power loss in a condenser when placed on A.C. or radio frequency, and is ever present to a greater or lesser degree. The effect of poor power factor in a condenser may be likened to that produced by building in a series resistor with an otherwise perfect condenser.

Poor power factor in a condenser may be caused by a number of reasons. For example, a poor or low grade of paper, poor or low grades of wax and oil, improper impregnation, high-resistance leads or tabs caused by tarnish or the use of solder, poor sealing, and many other small sundry reasons which close production control can eliminate.

Condensers today are available in many styles, shapes and containers. The particular type is a consideration usually dictated by the space and mounting room available in the radio receiver.

In replacing condensers, a Service Man sometimes places the condenser close to a resistor or a vacuum tube. The results are noticeable in a short time. The heat of the resistor or vacuum tube is absorbed by the condenser, melting the wax filler. The condenser is then forced to "breathe" by expansion and contraction as the set is turned on and off. As the seal of the condenser is ruined, moisture enters the unit and in short order the unit is made ineffective. Condensers should never be placed in close proximity to resistors, tubes or any other heating elements. Many manufacturers in designing equipment make the mistake of laying out the chassis with the tubes below the condenser, where convection currents of heat pass around the condenser, causing it to heat up. Melted wax, and the ulti-

mate invasion of moisture results in direct failure.

**SERVICING MULTI-BAND SETS**

In the servicing of multi-band receivers today, the Service Man will notice that the original manufacturer has had to resort to a few new tricks. Among those he saw was the difficulty in properly bypassing the radio-frequency current at widely different frequencies. In many cases, special condenser construction was required, such as in the shape of the unit, the casing or mounting, and the length, width and size of the leads.

Usually in replacing such a unit which has failed, it is necessary to use an exact duplicate replacement type in every respect, in order to have the set function properly over all the bands. Otherwise the units may be satisfactory on 3 or 4 bands, and be entirely unsatisfactory on the 5th, or ultra-high-frequency band, due to the lead length being large enough to resonate with the condenser, setting up a resonant circuit not desired on that particular band.

When replacing condensers in multi-band receivers, it is absolutely necessary that the leads be connected to the same point where the original condenser came off. It is absolutely necessary that the lead length be as short as possible, and that the replacement condenser be placed as near to the original relative position as possible.

At the ultra-high-frequencies, one can readily see where an addition of 1/8- or 1/4-inch will make an entirely different picture in the circuit and the receiver will not operate properly under those conditions.

It is also necessary to notice when servicing ultra-high-frequency equipment that the condensers are the non-inductive units.

This article has been prepared from data supplied by courtesy of Cornell-Dubilier Electric Corporation.

**NEW RADIO SERVICE "CAR"**

(Continued from page 13)

The unit starts instantly, is easy to operate, easy to balance and simple to steer and control.

The Motor Scooter is completely equipped with a powerful lighting system, good brakes and the necessary accessories for average safety and convenience.

Motor Scooter models in a number of styles and power are available through nearby branches of the manufacturer or may be obtained as a premium through the purchase of radio tubes and condensers on the terms of an offer made by the National Union Radio Corporation, to whose cooperation Radio-Craft is indebted for the specially-posed, exclusive photographs here reproduced.



Mr. Service Man: The scooter model shown above is a 3-wheeler, having a convenient side trunk (taking the place of the usual side car in the motor cycle) in which can be carried all the necessary service instruments, tools and manuals for any service call.

Please Say That You Saw It in RADIO-CRAFT



## OPERATING NOTES

(Continued from page 29)

the ganged tuning condenser should be removed, and contact and shaft polished with fine sandpaper. This will insure freedom from birdies that are hard to locate.

Tighten all tube socket contacts. It will be necessary to remove the filter block to reach the sockets of the types 80 and 47 tubes.

Always check the tone condenser before replacing the tone control. A leaky condenser here will ruin an expensive control.

**Sparton 913.** There are many of these old sets still afloat. One of these with an added amplifier using a 485 gave intermittent reception. With the aid of a new socket analyzer the trouble was found in the primary of the audio transformer of the added stage. This was replaced by capacity coupling. See Fig. 3.

To remove oscillation in this model bypass the plates in the R.F. box. The power-pack and the balancer in the 182B filament circuit are additional weak points.

This set may be retubed with types 27 and 71 tubes. If oscillation is encountered bypass the plates as above.

**Chevrolet 500,565.** Vibrator noise drowned-out the locals on this set. The vibrator pack was removed and a "B" eliminator substituted. The set worked fine. It was found that the filter condensers had dried out. They were removed. See Fig. 4.

As this was a hurry-up job an 8-mf. midget electrolytic was wired across the input. The vibrator noise almost vanished.

**Small A.C.-D.C. midgets.** Oscillation is a common complaint. It can be cured by shielding both detector and R.F. tubes. The detector grid lead may be too close to the 43.

Hum may be due to dried electrolytics as above. Cut loose the "B"-plus lead at the rectifier cathode or cathodes. Run this to "B"-plus of eliminator. Connect "B-" to set chassis. Don't ground either chassis. If you are on a concrete floor don't touch any bare shafts.

R. DECK, JR.

**Stewart-Warner R-172A, Firestone (Air Chief) R-166A Chassis.** Weak or no reception on the broadcast band. Short-wave reception OK. A short at the broadcast antenna shunt trimmer on top of the center section of the 3-gang tuning condenser has caused this trouble in a number of cases. A soldering lug on the condenser framework is too close to the trimmer and should be bent up to clear. This defect is hard to locate and requires very close inspection. On one Stewart-Warner this lug was just close enough to cause intermittent reception. It is advisable to check up on all models using this same tuning unit.

**Victor R-32, RE-45, R-52.** Quite often the 110-volt pilot bulb is found burned-out in these receivers. If other repairs are to be made at the same time it is a good idea to rewire for a 2.5-volt pilot bulb as these are always on hand and give sufficient light. The total cost of a new socket and bulb is no more than the 110-volt bulb and future replacements will be that much easier. Connections are made to the type 45 amplifier filament supply.

**Zenith 50 and 60 Series.** When any one of these receivers is very weak and an attempt to balance the trimmer condensers at any particular frequency makes it still weaker over the rest of the tuning range, remove the tuning condenser shield, loosen the screws holding the stator plates and center each section separately while fully meshed. Check the spacing again with the stators turned halfway out. It may be necessary to bend a plate here and there to obtain satisfactory clearance. Replace the shield and rebalance. If the spacing is carefully done the results are almost astonishing. An annoying hum at low volume levels in these sets may be suppressed by adding a 1.0-mf. condenser from the detector cathode to ground.

**RCA Victor 128, 224.** The peculiar condition may be encountered on these models where the receiver is totally inoperative except at one point on the broadcast band. A powerful station at 660 kc. is heard weakly at this setting, with another station whose regular assigned frequency is 710 kc. heard as a background. The trouble, unquestionably one in the oscillator circuit, will

be found due to a short-circuited oscillator section of the tuning gang, which is occasioned by the shorting of the heavy flexible copper banding lead, between gang condenser and chassis, to the busbar stator lead of the oscillator section. This pigtail is unnecessarily long and since the tuning gang is floated, trouble at this point is unavoidable.

The symptom of choked, irregular and distorted reproduction has been traced to a short-circuited or leaky 6B7 cathode bypass condenser. This is a 4 mf. electrolytic unit mounted on the terminal strip located near the rear wall of the chassis under the 6B7 socket. The degree of distortion will depend upon the leakage of the electrolytic condenser. The correct resistance to be obtained with an ohmmeter from the cathode of the 6B7 socket to chassis is approximately 4,000 ohms.

As with the models 121, 122, reception of almost all strong stations at two resonance peaks about 20 kc. apart, with distorted, muffled reproduction between these two points, is due to a short-circuited or leaky 0.05-mf. secondary-return bypass condenser of the I.F. stage. This condition will be noted only when the volume control is advanced to a higher level than usually maintained.

BERTRAM M. FREED

## NEW CIRCUITS IN MODERN RADIO RECEIVERS

(Continued from page 20)

### (4) DOUBLE-ACTING TONE CONTROL

**Sparton Models 1268 and 1288P.** In one unit, a tone control supplies bias for the driver and is active on both low and high frequencies in 2 stages.

As illustrated in Fig. 1D, from the viewpoint of the output stage the tone control 1-megohm potentiometer and the 0.01-mf. condenser with the 0.1-mf. condenser act to bypass the high frequencies increasingly as the slider is moved toward the right end. However, as it is moved toward the left end, to compensate for the apparent increase in volume, the intensity of the entire signal is reduced. The choke coil prevents high frequencies from being shorted out of the grid circuit while most of the grid impedance is shunted out by means of the 0.1-mf. condenser.

The D.C. bias for the 6J5G driver is supplied from the end of the field coil through a 270,000-ohm resistor.

### (5) AUTOMATIC TONE CONTROL

**Silvertone Model 6101; Factory No. 101.496.** Vacuum-tube tone control automatically reduces high-frequency response as volume is reduced.

The automatic tone control circuit is shown in Fig. 1E. From the ordinary diode 2nd-detector output volume control, the signal is conveyed to the grid of a 6U7G pentode with its screen-grid and suppressor-grid connected, and supplied with a positive screen-grid voltage through a 50,000-ohm resistance load. The plate is connected through a 0.5-meg. resistor to the A.V.C. supply lead. In addition, a manual tone control is connected from the common screen-suppressor connection to ground.

Using this grid connection as an anode, the signal introduced into the 6R7G grid depends on the ability of the 6U7G to amplify or at least transfer the signal to the 6R7G grid. At low signal strengths the 6U7G plate is practically at ground potential and the tube operates to shunt out practically all high frequencies. As the signal increases, the plate is driven negative improving the characteristics of the tube to amplify high frequencies which are carried to the 6R7G control-grid. As the high frequencies are decreased with volume, there is somewhat less tendency toward background noise on low signals.

## HOME-MADE PORTABLE RADIO SET

"Going places" this summer? Take along a 4-tube portable radio set—use it at camp, on the lake, etc. Complete construction details in August *Radio-Craft*, on the newsstands July 1.

## AERIAL INSTALLATION PROVES EXTRA INCOME FOR RADIO SERVICE MEN!

CHINE

TURN idle hours into profit! Every customer a prospect for a better aerial . . . and you can easily sell them on the idea.



Install the new "MULTI-COUPLER" ANTENNA SYSTEM, the latest all-wave noise-reducing antenna system employing many vitally important improvements. Master antenna systems are equally adaptable to private homes as they are to large apartment buildings.

Installation season starts NOW! We furnish standard installation specifications FREE, and help you solve special antenna problems.

For complete details, write today. Address Dept. C.

AMY, ACEVES & KING, INC.

11 West 42nd Street, New York, N. Y.  
Consulting Engineers—Specialists in Antenna Systems—Licensor of leading Set and Antenna Equipment Manufacturers.

Judged by the number in use TODAY'S MOST POPULAR Tube Tester



Model 430 Dealer Price

ONLY \$19.80

- Line Voltage Adjustment
- Leakage and Short Test
- Uses Triplett (GOOD-BAD) Instrument

• Positively Checks Radio Receiving Tubes According to Latest Recommendations of

Tube Engineers. Five flush type sockets provide for all tubes. Complete in attractive, sturdy, quartered-oak case. Sloping etched panel of silver and black. Suitable for portable or counter use.

Model 431 same as 430 except has Readrite (GOOD BAD) meter . . . Dealer Price \$15.90

A MODIFIED EMISSION TYPE TESTER . . . APPROVED CIRCUIT

*Readrite*

READRITE METER WORKS  
716 College Ave., Bluffton, Ohio

—Please send me more information on Model 430.  
—Model 431.

Name . . . . .  
Address . . . . .  
City . . . . . State . . . . .

Please Say That You Saw It in RADIO-CRAFT

# FOUR NEW 10¢ RADIO BOOKS!



**RADIO FANS EVERYWHERE**—these little ten cent text books give you an excellent foundation for the study of radio. They are clearly written, profusely illustrated and contain over 15,000 words in each book. You'll be amazed at the wealth of information these volumes have. They are handy for review or reference books.

**NO. 5—BEGINNERS' RADIO DICTIONARY**

Are you puzzled by radio language? Can you define frequency? Kilocycles? Tetrode? Screen grid? Baffle? If you cannot define these very common radio words and dozens of other, more technical, terms used in all radio magazines and instruction books, you need this book in your library. It's as modern as tomorrow—right up to the minute. It tells you in simple language just what the words that puzzle you really mean. You cannot fully understand the articles you read unless you know what radio terms mean. This is the book that explains the meanings to you. Can you afford to be without it, even one day longer?

**NO. 6—HOW TO HAVE FUN WITH RADIO**

Stunts for parties, practical jokes, scientific experiments and other amusements which can be done with your radio set are explained in this fascinating volume. It tells how to make a newspaper talk—how to produce silent music for dances—how to make visible music—how to make a "silent radio" unit, usable by the deafened—how to make toys which dance to radio music—alright clever and amusing stunts in all. Any of these can be done by the novice, and most of them require no more equipment than can be found in the average home. Endless hours of added entertainment will be yours if you follow the instructions given in this lavishly illustrated book.

**NO. 7—HOW TO READ RADIO DIAGRAMS**

All of the symbols commonly used in radio diagrams are presented in this book, together with pictures of the apparatus they represent and explanations giving an easy method to memorize them. This book, by Robert Eichberg, the well-known radio writer and member of the editorial staff of RADIO-CRAFT magazine, also contains two dozen picture wiring diagrams and two dozen schematic diagrams of simple radio sets that you can build. Every diagram is completely explained in language which is easily understood by the radio beginner. More advanced radio men will be interested in learning the derivation of diagrams, and the many other interesting facts which this book contains.

**NO. 8—RADIO FOR BEGINNERS**

Hugo Gernsback, the internationally famous radio pioneer, author and editor, whose magazines, **SHORT WAVE & TELEVISION** and **RADIO-CRAFT** are read by millions, scores another triumph with this new book. Any beginner who reads it will get a thorough ground work in radio theory, clearly explained in simple language, and through the use of many illustrations. Analogies are used to make the mysteries of radio as clear as "2+2 is 4". It also contains diagrams and instructions for building simple radio sets, suitable for the novice. If you want to know how transmitters and receivers work, how radio waves traverse space, and other interesting facts about this modern means of communication, this is the book for you!

**Other Titles in This 10c Book Series!**

- No. 1—HOW TO BUILD 4 DOERLE SHORT-WAVE SETS
- No. 2—HOW TO MAKE THE MOST POPULAR ALL-WAVE 1- AND 2-TUBE RECEIVERS.
- No. 3—ALTERNATING CURRENT FOR BEGINNERS
- No. 4—ALL ABOUT AERIALS

Four other volumes in this ten-cent radio book series—each on a popular subject—are available. The titles are:

RADIO PUBLICATIONS, Dept. RC-738  
101 HUDSON STREET, NEW YORK, N. Y.  
Gentlemen: Please send immediately, **POSTPAID**, the book numbers circled below. I am enclosing ..... cents—each book being 10c.

Send **FREE** listing of 48 new 10c publications.

Name .....  
Address .....  
City ..... State .....

Remit by check or money order—register letter if you send cash or unused U. S. postage stamps.

**MAIL COUPON TODAY!**

**BOOKS ARE ALL UNIFORM**

Every book in the GERNSBACK EDUCATIONAL LIBRARY has 32 pages—with illustrations varying from 30 to 66 in number. Each title volume contains over 15,000 words. Positively radio's greatest book buys! If you do not think these books worth the price asked, return them in 24 hours and your money will be instantly refunded.

**RADIO PUBLICATIONS**  
101 Hudson Street New York, N. Y.

**Correspondence Courses in Radio and ELECTRICAL ENGINEERING**

**ELECTRICAL ENGINEERING** Get good grasp of this field. Prepare yourself, at Low Cost, for secure future. Modern, simplified, you can understand quickly.

**RADIO ENGINEERING** Extra fine course in radio. Public address, photo-electric work, vacuum tube technician. Exper. kits furnished. Diploma on completion. Tuition, \$25, either course. Deferred payment plan. Get copies of school catalog, student magazines, complete details. **SEND NOW!**

LINCOLN ENGINEERING SCHOOL, Box 931-98, LINCOLN, NEBR.

**PATENTS—TRADE MARKS**

All cases submitted given personal attention by members of the firm.

Form "Evidence of Conception" and instructions  
"How to Establish Your Rights"—Free

**LANCASTER, ALLWINE & ROMMEL**  
PATENT LAW OFFICES  
436 Bowen Bldg. Washington, D. C.

**MANY NEW RADIO BOOKS** have been added to the ever-popular RADIO-CRAFT LIBRARY SERIES. Please turn to page 58 and read the announcement on all the books in this series.

**WE HAVE The RADIO YOU WANT**

How would you like to save up to 50% on Nationally advertised Radios, such as Stromberg Carlson, Philco, RCA, Zenith, G. E. etc. etc., for home, farm and auto, over 400 models to choose from. Also hundreds of electric appliance items for the home. Write today for the new 1938 giant catalog **FREE**.

MODELL'S Dept 57, Corrhoad St., N.Y.C.

**RADIO WITTIQUIZ**  
(Continued from page 35)

epithet for the horse you bet on. (c) Used in conjunction with a jack to connect external equipment or parts in a circuit.

A. WILSON  
Toronto, Ont., Can.

(96) A *Western Union joint* is—  
(a) The place where you go to send telegrams. (b) A new and improved type of universal joint. (c) The bad knee telegraph messengers get from riding their bicycles. (d) A simple, approved method of joining the ends of two wires so as to be mechanically strong and to preserve conductivity.

(97) A *ground wire* is—  
(a) A conduit run under the ground. (b) A wire used to connect an electrical device to a ground plate or water pipe. (c) A wire that is drawn rough, and ground down to correct size.

E. W. WITTE

(98) Everyone knows that a *shield* is—  
(a) Something Roman soldiers used to carry. (b) Something to keep tinkers (and mice) away from vital radio parts. (c) A piece of metal placed between 2 or more radio components to prevent interference or coupling between them.

NEAL S. GERISH

**ANSWERS**

(85d)	(86b)	(87c)	(88d)	(89c)
(90d)	(91a)	(92c)	(93a)	(94c)
(95c)	(96d)	(97b)	(98c)	

**CONTEST RULES**

- (1) An award of a 1-year subscription to *Radio-Craft* will be given to each person who submits one or more WITTIQUIZZES that the Editors consider suitable for publication in *Radio-Craft*.
- (2) WITTIQUIZZES should preferably be typed; use only one side of paper.
- (3) Submit as many WITTIQUIZZES as you care to—the more you submit the more chance you have of winning—but each should be good.
- (4) Each WITTIQUIZ must incorporate humorous elements, and must be based on some term used in radio, public address or electronics. Each WITTIQUIZ may have 4 "answers," only 1 of which of course will be correct; and, only 1 of which is non-radio.
- (5) All answers must be grouped, by question number and correct-answer letter, on a separate sheet of paper.
- (6) All contributions become the property of *Radio-Craft*. No contributions can be returned.
- (7) This contest is not open to *Radio-Craft* employees or their relatives.
- (8) The contest for a given month closes on the 15th of the 3rd month preceding magazine-issue date. (For instance, contributions to Sept., 1938, *Radio-Craft*, on the newsstands about August 1, must be received at *Radio-Craft* editorial offices not later than June 15, 1938.)

Please Say That You Saw It in RADIO-CRAFT

## TELEVISION WITHOUT SCANNING?

(Continued from page 12)

the minority of people rather than the majority. If we extend this reasoning into engineering, we might then say, "In a new science, there is the possibility that the majority of engineers are doing the wrong thing."

Let us therefore, join the minority and detach ourselves and come out from under the influence of popular theory and practice and take a new channel of thought; let us dare to look at El Dorado. Can we think of a television system without scanning? I can think of a very good and very logical way in which television may be accomplished with optical and electronic means without scanning!

When I first considered these possibilities, they were in the form of amusing thoughts, but as time has passed, I have been inclined to look at these possibilities more and more seriously. I have been further stimulated to point out to the uninformed that television must not be counted as an addition to a radio set where one will see the comparatively uninteresting images of people reading script before a microphone in a broadcasting station, but rather an entirely new and separate service. It will be unimportant to the user of television how the pictures get onto the screen in his home. He will be satisfied to have it arrive via wire, radio, or pipe as long as it is clear and not too expensive nor cumbersome.

Therefore, let us look into a system which is extremely simple in principle, comparatively inexpensive, and much higher in fidelity than the present scanning type of television.

### A "SCANNER-LESS" SYSTEM OF TELEVISION

Let us assume that we go to the top of a tower in the center of a city and set up a large modern motion picture projector with a wide-angle projection lens. Further assume that we may use a powerful source of infra-red radiation rather than an arc light on cloudy or rainy days for illuminating the film. We project the image directly out into space from the projector just as though a screen were present; while at the same time using no screen or objective lens. Again assume that we use several of these projectors and point them in all different directions so that we cover a complete circle. Let us imagine that such a tower will look like the artist's conception shown in Fig. A.

If these projectors were set into operation and anyone went to the roof of his house and looked through a pair of binoculars, he would see a clear and distinct view of the motion pictures just as though a screen were present. If he used a large spyglass or telescope, he might actually project a very small picture on a screen from the eye piece. The image becomes dimmer and smaller as one moves farther away from the original projector, and finally, becomes invisible. If a man constructed a periscope in combination with his telescope, he could then stay inside of the house without going to the roof and see the motion pictures. This might be called a form of "peephole" television. The optics of such a system are shown in Fig. 1. Like all telescopic images, they would be small and lack brilliancy.

We can see at a glance that all we need is the counterpart in optics of the amplifying radio tube and loudspeaker in radio broadcasting systems. See Fig. 2. If we can amplify the brilliancy of the light and project a small picture received upon a large screen, we have a rather satisfactory television system without much fuss and commotion, providing the light amplifier is not too complicated. Certainly the cost of the periscope, the tubing and the projector in the tower is insignificant compared to a television transmitter and receiver. If the light amplifier is cheap, then the whole system is cheap.

Furthermore, the definition of the picture is as good as that of the motion picture and there is nothing left to be desired with the exception of overcoming the obstacles of dust, smoke and fog which would obscure the picture if one is very far away from the projector. If, however, the light amplifier could work on long, infra-red rays—which pass easily through smoke and fog—and convert this infra-red radiation into visible radiation directly just like a radio receiver converts high-frequency carrier signals into audible voice signals, then we could see the images at all times of day or night regardless of weather conditions by just raising the "gain" (amplification) on our "light amplifier" just as, similarly, we increase the volume control on the "audio

amplifier" of our radio receiver for a distant station.

### PROBLEM: THE "LIGHT AMPLIFIER"

It is readily apparent that this entire plan depends upon a successful light amplifier which will amplify the size and brilliancy of the picture without distorting it. A cascade system of modern electron image tubes appears to answer this requirement very nicely.

By reference to Fig. 3, we see a form of electron image tube; as described in a past issue of Radio-Craft, a sensitive photoelectric coating is deposited upon one end like a camera plate film. The lens focuses an image of a performer upon this photoelectric surface. Electrons leave this surface in proportion to the strength of the light falling thereon, that is, many electrons leave from the points where there is considerable light and no electrons leave from the black parts of the picture where there is no light. These electrons are accelerated in straight lines through the rings charged to a positive potential in front of the photoelectric coating which is charged negatively. Since these electrons travel through the opening like light through a pinhole camera, or through a lens, they are focused upon the fluorescent screen at the other end of the tube where we obtain a reproduction of the image focused upon the photoelectric material at the other end.

Since the brilliancy of the image is proportional to the potentials applied between the cathode and rings as well as the number of electrons released, it is only necessary to apply higher potentials to increase the brilliancy up to certain limits. Therefore, a feeble image—small, and dimly illuminated on the photoelectric end—becomes a strong, bright image on the fluorescent end of the tube. This image is comparatively undistorted and is limited in quality only by the texture of the photoelectric deposit and the fluorescent screen.

If, after one stage of amplification through a tube of this kind, the image is still too small and too weak in brilliancy, we can add another tube just like we do in a radio receiver or amplifier when the sound is too weak. We then place the photoelectric material in one tube right up next to the fluorescent screen of the other and amplify the picture brilliancy. We can repeat this operation again and again just as we add one tube after another in radio practice until we reach the limit of amplification.

A complete illustration of a machine for picking up this extremely weak image and projecting it upon a screen in your living room is shown in Fig. B. Such a device only requires a source of voltage from a rectifier, and negligible power as compared with a radio receiver; and there is nothing about the light amplifier tube to wear out for many years! There is no scanning; there are no controls for synchronizing or tuning; there is only the necessity for one control and this is a mechanical iris like the diaphragm on a camera which can be automatic or manual like the volume control on your radio receiver. There is no electrical interference, and briefly, no fuss and commotion.

We are so seriously interested in the possibilities of this equipment that we are giving it considerable attention in our laboratory. We have every reason to believe that other laboratories actively engaged in television development are doing the same thing.

### ANSWERING QUESTIONS

There is one point that I am sure you are wondering about, which I almost neglected to explain. The natural question at this moment is, "How could we pick up sporting events or any action and transmit them immediately without reducing the action upon film first for projection through the tower lantern?" The answer is best illustrated by saying, "How do you pick up a signal from a speaker's voice in a microphone and build it up to a large enough energy to broadcast it everywhere from a powerful radio station?" The answer to this is, "We amplify it." Obviously then, we use the same kind of amplifying projectors to pick up the original event. We amplify the light and we project it. Certainly, we use bigger tubes and bigger periscopes and telescopes, but we can pick up any action and rebroadcast it. We use infra-red rays or light as a carrier.

Now you may say, "This system is limited by (Continued on following page)

## EVERYTHING IN RADIO AT LOWEST PRICES



**56  
NEW  
SETS**



**NEW KITS**

Dealers! Service Men! Sound Men! Amateurs! Set Builders! ALLIED'S big, new Spring-and-Summer Catalog brings you everything in Radio—at sensationally low prices! Over 12,000 parts; revolutionary new P.A. Systems for every purpose—10 to 60 watts—portable, mobile, permanent; all types of latest test equipment; new Amateur Gear; Kits; books, tools, etc.—and 56 new, super-value KNIGHT Radios with Push-Button Tuning, etc., at amazing low prices. Radio men everywhere say: "ALLIED'S catalog saves you time and money!" Send coupon now for Spring-and-Summer Issue—It's FREE!

**FREE! RADIO BUILDER LISTS**

We supply Free Parts Lists of matched kits for building any circuit described in this or any other magazine. Just specify where seen.

## FREE CATALOG

ALLIED RADIO CORP.  
833 Jackson Blvd. Dept. 2-G-38  
Chicago, Ill.

Send me your new Spring-and-Summer catalog—FREE.

Name .....

Address .....



## Tiny, but...

- ★ It's a genuine hermetically-sealed metal-can electrolytic with insulating jacket.
- ★ 4, 8, 12, 16, 24, 30 and 40 mfd. 150, 250, 350 and 450 v. d.c. working.
- ★ Insulating jacket edges spun over can ends. Leads can't short on can. Red and black end disks indicate polarity. Provided with vents.
- ★ Logical choice where space- and cost-saving are absolutely necessary.

### Ask Your Jobber . . .

- ★ We'll show you these latest space-saving electrolytics. Ask for literature—from him or from us direct.

# AEROVOX

CORPORATION

70 Washington St.      Brooklyn, N. Y.

IN CANADA: AEROVOX CANADA, Limited Hamilton Ont.

Please Say That You Saw It in RADIO-CRAFT



# Many NEW Titles to Choose from the RADIO-CRAFT LIBRARY SERIES

PRESENTED on this page are all the books in the RADIO-CRAFT LIBRARY SERIES—the most complete and authentic set of volumes treating individually important divisions of radio, refrigeration and air conditioning. Each book has been written for the purpose of giving you the opportunity to specialize in one or more of the popular branches of the subjects mentioned. The material in these books is very helpful . . . you'll find them valuable in your work. The authors of these books are well-known—they are authorities on the subjects on which they have written. This is the first time that you are enabled to build a library of uniform technical books by such popular writers.

### Here Are the Titles

Book No. 2  
**MODERN VACUUM TUBES**  
And How They Work  
with Complete Technical Data on All Standard and Many Special Tubes  
By ROBERT HERTZBERG

Book No. 3  
**THE SUPERHETERODYNE BOOK**  
All About Superheterodynes How They Work, How to Build and How to Service Them  
By CLYDE FITCH

Book No. 6  
**BRINGING ELECTRIC SETS UP-TO-DATE**  
With Pentodes, Multi-Mus, Dynamic Speakers—Complete Information on How to Modernize A.C., D.C., and Battery-Operated Receivers  
By CLIFFORD E. DENTON

Book No. 9  
**AUTOMOBILE RADIO AND SERVICING**  
A Complete Treatise on the Subject Covering All Phases from Installing to Servicing and Maintenance  
By LOUIS MARTIN

Book No. 10  
**HOME RECORDING AND ALL ABOUT IT**  
A Complete Treatise on Instantaneous Recordings, Microphones, Recorders, Amplifiers, Commercial Machines, Servicing, etc.  
By GEORGE J. SALIBA

Book No. 12  
**PUBLIC ADDRESS INSTALLATION AND SERVICE**  
Modern Methods of Servicing and Installing Public Address Equipment  
By JOSEPH T. BERNSELY

Book No. 13  
**ABC OF AIR CONDITIONING**  
An Accurate Simplified, Technical Review of the Fundamentals of This Latest Branch of Engineering, Including Servicing Data on Present-day Units  
By PAUL D. HARRIGAN

Book No. 14  
**POCKET RADIO GUIDE**  
Handy Reference Book for Radio Men—Set Construction Articles—Audio Amplifier Circuits—Useful Radio Formulas and Data—Handy Short Cuts—Index to Important Articles Printed in Radio-Craft Magazine  
By N. H. LESSEM

Book No. 15  
**ABC OF REFRIGERATION**  
A Compendium of the Principles of Refrigerating for Service Men with a Detailed Listing of Defects and How to Overcome Them, with Hints on Setting Up a Service Shop  
By TRAFTON MASON

Book No. 16  
**PRACTICAL RADIO CIRCUITS**  
A Comprehensive Guide to All Types of Radio Circuits for the Service Man, Constructor and Experimenter  
By DAVID BELLARE

Book No. 17  
**SERVICING WITH SET ANALYZERS**  
A Study of the Theory and Proper Applications of Modern Set Analyzers and Associated Apparatus  
By H. G. MCENTEE

Book No. 18  
**POINT-TO-POINT RESISTANCE ANALYSIS**  
Theory—And Application of This Modern Test Procedure in Every-day Radio Service Problems  
By BERTRAM M. FREED

Book No. 20  
**THE CATHODE-RAY OSCILLOSCOPE**  
Theory and Practical Applications  
By CHARLES SICURANZA

Book No. 21  
**BREAKING INTO RADIO SERVICING**  
Simple Instructions and Procedure for Starting a Profitable Radio Business of Your Own  
By ROBERT EICHBURG

**ALL BOOKS UNIFORM**  
The books in the RADIO-CRAFT LIBRARY SERIES are all uniform . . . size 6 x 9 inches. Each volume contains an average of 50 to 150 illustrations. The books are printed on an excellent grade of book paper.

## TELEVISION WITHOUT SCANNING?

(Continued from preceding page)

the horizon. Any building will shadow reception and we shall have to extend our periscopes up high enough to see over them." To this, my answer is, "These same limitations apply to ultra-shortwave television using scanning. If one objects to the tubing on our periscopes, how about the coaxial cable for ultra-shortwave television? The tubing for the periscope is actually cheaper and easier to install and service."

If one says, "How about the lens on the roof?" We answer, "It is cheaper than the dipole antenna required for good television reception."

Then if one asks, "How about the light amplifier tubes?" We can say, "They should certainly be less expensive than a modern television receiver."

### CONCLUSION

In conclusion, even though the modern scanning television system be highly practical and useful, we have herein another way of doing the same thing in an equally effective manner by using electronic and optical means, and it is further possible that we may come to have two great entertainment utilities tomorrow instead of one, just as we have gas and electric companies now giving the same general kind of service in a different way. We may have the radio system for certain locations where periscopes will not be so easily installed, and we may have periscopes where the radio systems may not be so easily used. In fact, we may hear the announcers of tomorrow saying, "This is John Brown of the All at Once Company signing off," or, "This is Jones of the Spot-by-Spot network."

Are we serious? Do we expect to announce such a thing in the near future and make a demonstration of it? Time will tell, and I am willing to wager that upon reading this article, several Eastern Laboratories I am thinking about will put on double speed to beat us to it.

## SERVICE MEN!—REPAIR YOUR CUSTOMERS' SETS "BETTER THAN NEW"!

(Continued from page 17)

back a chassis that tunes-in notes on resonance, and high-frequency on the sidebands, give him the whole musical scale at once, that is what you are being paid for. If the customer wants a radio set for distance work, sell him a professional communications job.

When spreading the I.F. curves you will probably lose some gain, but this decrease of sensitivity is more than offset by the improved tone quality of the set. Remember, the primary purpose of an oscilloscope in service work is to give you a visual indication of the selectivity of the radio set under test. Just peaking the I.F. stages for maximum gain can be done just as efficiently with an ordinary output meter.

Next we adjust the wavetrap for minimum peak, and then align the R.F. and oscillator circuits. If necessary, bend the oscillator condenser plates to insure proper tracking of the pointer to the dial calibration; once again it will probably be necessary to sacrifice some sensitivity in order to keep the dial pointer on calibration at the low-frequency portion of the dial, but it will please the customer to know that he can now tune-in stations exactly where the newspapers say they are. Now take an overall selectivity check of the chassis by supplying a 1,400 kc. signal to the antenna terminal, and make any slight adjustments necessary to the I.F. trimmers to give a nicely balanced wave form.

Now the job is practically finished, connect the oscilloscope to the voice coil of the speaker, and supply a 400-cycle audio note to the output of the 2nd-detector, check the resultant image for essentially pure waveform at moderate volume; if bad distortion is noticed, check the audio resistors, coupling, and bypass condensers and transformers until the faulty part is located. Shut off the oscilloscope and run the audio generator through its entire range to check the speaker for cone rattles. Now connect the radio receiver to an antenna equivalent to the one used by the customer and let the set run for a half-hour on a local station as a check on fading, while you prepare the next chassis for the oscilloscope.

RADCRAFT PUBLICATIONS, INC. • 99 HUDSON ST. • NEW YORK, N. Y.

### CLIP COUPON — AND MAIL TODAY!

RADCRAFT PUBLICATIONS, INC., Dept. R6-738, 99 Hudson St., New York, N. Y.

I have circled below the numbers of books in the RADIO-CRAFT LIBRARY SERIES, which you are to send me POSTAGE PREPAID. My remittance of \$..... is enclosed at the cost of fifty cents for each book.

The amount of my remittance is..... (Stamps, checks or money orders accepted.)

Circle numbers wanted: 2 3 6 9 10 12 13 14 15 16 17 18 20 21

Name ..... Address .....

City ..... State .....

Send remittance by check, stamps or money order; register letter if you send cash or stamps.

Please Say That You Saw It in RADIO-CRAFT

## AMERICA'S RADIO COLOSSUS

(Continued from page 13)

Its stockholdings in the Canadian Marconi Company were sold for \$1,725,000 in cash. The profit from this transaction will be credited in this year's account to Earned Surplus.

Of the company's total assets approximately 94 per cent is now represented by investments in the United States, only 6 per cent remaining in other countries. These latter investments, nearly all of which are wholly-owned subsidiaries, are largely confined to South and Central America. This does not mean that they are withdrawing from the foreign field, for they have patent license and engineering service agreements with leading companies in the principal foreign countries, resulting in payment to it of substantial royalty and service fees. The RCA Manufacturing Company also does an extensive export business in many parts of the world with radio receiving sets, tubes, broadcast transmitters, sound motion picture equipment and related products.

Among its liabilities is \$10,400,000 of notes payable to banks. Ten million dollars of this amount was borrowed from banks in 1936 to finance the retirement of the company's 7% "A" Preferred stock. Twenty-four million dollars of this amount was paid off in notes to banks, reducing the remaining liability to \$8,000,000 and saving thereby \$58,000 a year in interest charges.

### TAXES

This huge corporation does not thrive without paying for its business privileges; and it pays well. RCA last year paid in taxes a total of \$4,297,500. The total of all taxes for the year 1937 equalled 42 cents a share on the Common stock of the company—almost exactly the figure earned on these shares. The government received more than twice the amount in taxes that the stockholders of Common stock received from dividends for the year. The radio industry is not only a large tax-payer but has become a substantial member of the American business community employing many thousands of workers and bears its huge share of civic and social responsibility.

### MANUFACTURING

At the present time the company is operating at a profit in all of its divisions. The steep decline during recent months of the nation's volume of business and profits has affected its income and profit figures. Nevertheless it is estimated that the net profit for the first-quarter of this year will be more than adequate to cover the Preferred dividend requirements, leaving a small balance applicable to the Common stock.

Its manufacturing divisions have developed and produced a widely diversified line of modern products. Radio receiving sets, although an important item, are only a partial source of its sales. Records, phonographs, combinations, and record players represent an important and profitable line which has grown rapidly in recent years due to recording and reproducing improvements based on radio inventions.

RCA Photophone equipment for motion picture studios and theatres is now strongly entrenched in this field. If you have seen "Snow

White and the Seven Dwarfs," you have seen one of the more important pictures which are completely RCA-equipped (so far as sound is concerned).

Other products include transmitting apparatus for broadcasting stations, sound systems for schools and auditoriums, aircraft and airport radio equipment, police radio systems, equipment for amateur use, and tubes of all kinds and for all purposes.

### RESEARCH

All these products are the fruit of research which is constantly going on in their elaborately-equipped laboratories. The two most important products of radio research now in advanced stages are Television and Facsimile.

Various broadcasting stations have already commenced experimental transmission by facsimile of news bulletins and pictorial material to a limited number of receivers in their local areas. The fundamental technical problems of facsimile have been solved and RCA is now building facsimile transmitters and several hundred receivers which have been ordered by independent broadcasting stations.

While the technical and economic problems of television are far more complicated, definite progress is being made toward their solution. Television pictures are larger, sharper and more brilliant than a year ago due to marked improvements in both transmitting and receiving apparatus. The industry must now decide upon the acceptance of definite technical standards before any public television service can be made practicable.

### COMMUNICATIONS

The direct contact which RCA Communications facilities afford with 43 foreign countries is an important factor in our international relationships. In time of war these facilities would be indispensable as an important arm of our national defense and in times of peace they are of vital importance in helping to guarantee not only the unhampered communication between our government and foreign countries but also to keep these same avenues of communication open for our newspapers, financial institutions, business enterprises and our people in general.

Further, the daily short-wave programs of the National Broadcasting Companies to foreign countries, operating continuously 18 hours a day, broadcast in 6 different languages, serve as an ambassador of good-will every day in the year. Through both its national and international services day by day assistance is rendered to many branches of the government including the Departments of State, War, Navy, Interior, Commerce and Agriculture. These facts, however, tell only a small part of the story of how this tremendous radio organization serves the "public interest, convenience and necessity."

Radio is the greatest gift of education, culture and entertainment ever presented to more than 100,000,000 people. Radio has broken down age-long barriers of distance and isolation and to this tremendous radio organization, the Radio Corporation of America, rightfully goes a huge share of the credit.

## "WHEN YOU CAN MEASURE"

Under this title General Electric Co. has just released a 32-page brochure which radio men may obtain upon application on their business letter-head.

Telling in brief the contributions of G.E. engineers and scientists to the important art of Measurement, this attractive, beautifully-printed publication describes in pictures and words the story of how instruments are designed, constructed and tested by this group.

Every development in electricity has grown out of experiments in which instruments played a major part. The incandescent lamp, the electric motor, electric household appliances, radio sets and apparatus of all kinds—none of these commonplace of modern living would have been possible without the imposing array of ingenious,

sensitive, accurate measuring devices engineers have perfected.

Since measurement, in its final form, depends upon comparison with some carefully-chosen standard, a section of the booklet is given over to a description of the Company's standards of Voltage, Resistance, Time and Temperature.

### "CONTINUOUS-FILM TELEVISION"

Under this title readers of August Radio-Craft (newstand, July 1) will find a description of P. T. Farnsworth's latest contribution to the art of television.

Please Say That You Saw It in RADIO-CRAFT

## EASIER THAN EVER

RADIO PHYSICS COURSE

A. A. Ghirardi  
972 PAGES  
508 ILLUS.

THIS 1 BOOK TEACHES YOU EVERYTHING

Without any previous training you can now master the whole science of Radio, Electricity and Television quickly and easily by reading Ghirardi's famous home-study RADIO PHYSICS COURSE. Its many exclusive features and plain, easy-to-understand language account for its use by more radio sets and students than any other radio book in the world.

only \$4

HERE'S WHAT YOU GET:

Sound—Electrical Theory and Principles—Electrical Currents—Electro-magnetism—Transformers—Inductance—Condensers—Measuring Instruments—Radioactivity—Broadcasting—Receiving—Vacuum Tubes—Amplification—Superhets—Coils—Speakers—Receivers of all types—Short-Wave—Auto-Radio—Aircraft Radio—Public Address—Photocell Cells—Cathode-Ray Tubes—Television—Testing and Servicing—Sound Motion Pictures—Reference Tables—550 Review Questions for Self-study—and DOZENS of other subjects!

#### TRY IT!

Ghirardi's 1 Big Book will get you started in Radio quickly, simply, easily! Grab this marvelous bargain now—order your copy this easy way! Write your name and address on this ad—send it in with \$4 today (\$4.50 foreign). Every penny of your money back if not satisfied. Free Circular—no obligation. Write at once!

RADIO & TECHNICAL PUBLISHING CO.  
45 Astor Place, New York Dept. RC-78

## TO LEARN RADIO!



### SPEED UP

Your Service Work with GHIRARDI'S GADGETS

In a flash these amazing Pocket Trouble Shooters spot over 800 different set troubles—give you exact TESTS and REMEDIES. One each for HOME and AUTO radios. 5-day Trial. Free Circular—no obligation! Write RADIO & TECHNICAL PUBL. CO., 45 Astor Pl., Dept. RC-78, New York.



Code F18

Use "Bi-passit" for quiet radio reception. Interference from electric shavers, sewing machines, refrigerators, and countless electrical appliances is stopped by Bi-passit, the bakelite Filternoys suppressor made by CONTINENTAL CARBON, Inc. For use on grounded a-c circuits. Code F18, each 35c

Quiet severe interference with Filternoys FO1DH, dual choke, triple capacity filter with the ground lead that diverts radio interference to the earth. Recommended for washing machines, hair driers, dental motors, food mixers, electric shavers, cash registers, etc. Five ampere current carrying capacity! For any a-c or d-c power mains up to 120 volts. Enjoy radio at its best, without interference. Code FO1DH, each \$1.00



Code FO1DH

## CONTINENTAL CARBON Inc.

13914 LORAIN AVE., Cleveland, Ohio  
Also, Toronto, Canada  
Makers of Carbon Resistors, Paper Condensers, and Noise Suppressor Filters

# A FREE BOOK FOR EVERYONE IN RADIO

**RADIO-CRAFT**—complete in everything radio men need, gained popularity and leadership in a few years. Never once has **RADIO-CRAFT** shortened its stride of editorial progress. Broader in news scope—excellence in illustrations—continued improvement in editorial technique—accuracy in wiring diagrams and schematics—these are the basic ideals upon which **RADIO-CRAFT** success has been achieved.

The publishers of **RADIO-CRAFT** make you a very liberal offer—they want you to read every monthly issue—they want you to get the benefits as do thousands of other readers—they have arranged a special offer with an attractive premium—and they have made a special price for you.

To readers of this announcement the **SPECIAL OFFER** is a **SEVEN MONTHS' SUBSCRIPTION** to **RADIO-CRAFT** and a **FREE COPY** of the **1938 RADIO REFERENCE ANNUAL**. If you are a regular subscriber at the present time, you may take advantage of this opportunity just the same. The publishers will be glad to extend your present subscription an additional Seven Months, and at the same time, send you a **FREE** copy of this new book.

Use the coupon below for entering your subscription to **RADIO-CRAFT**.

## Here is the Contents of the 1938 RADIO REFERENCE ANNUAL

**SET BUILDING**  
This particular section of the 1938 **RADIO REFERENCE ANNUAL** contains a description of a number of important, as well as interesting receivers. They are as follows: A Simplified Converter, A Farm Battery Receiver, An Executive's A.C.-D.C. Desk Set; Handy Book-End Novel Receiver. Other receivers described are: Crystal Set, Portable Battery Receiver, and several others. Each receiver is described accurately, complete with constructional data and list of parts required.

**SERVICING**  
This chapter is devoted to Radio service instruments in general. Special emphasis is given to a number of the more essential instruments—they are: Service Oscillators, Mixer Circuits, V.T. Voltmeters and an Interference Eliminator.

**PUBLIC ADDRESS**  
For those who find public address their chief interest, here you will find complete

design and construction on a P. A. Tuner; a Handy Amplifier; and an Infinite Baffle Loud Speaker.

**TEST EQUIPMENT**  
Radio Service Men who prefer to build their own equipment will find all the construction details necessary for building the following: Condenser Analyzer, Midrange Oscilloscope with 1" and 2" tubes; Service Audio Oscillator.

**GENERAL INTEREST ARTICLES**  
A variety of topics have been selected for their interest and importance. These subjects cover—Home Broadcaster; Remote Set Tuning; Carrier-Type Interphone Systems and a number of others.

**MISCELLANEOUS**  
A comprehensive index of important articles which appeared in **RADIO-CRAFT** during 1937. This section also includes data on recently developed tubes and many other helpful hints and suggestions.

64 pages :: Over 90 Illustrations

## RADIO-CRAFT

99 Hudson Street,  
NEW YORK, N. Y.

**RADIO-CRAFT, 99 Hudson Street, New York, N. Y.**

RC-738

Gentlemen: Enclosed you will find my remittance of One Dollar (\$1.00) for which enter my subscription to **RADIO-CRAFT** Magazine for Seven Months. Send me, **ABSOLUTELY FREE**, and **POSTPAID**, my copy of the **1938 RADIO REFERENCE ANNUAL**.

New Subscriber       Extend present subscription

Name ..... Address .....

City ..... State .....

(Send remittance by check or money order. Register letter if you send cash or unused U. S. Postage Stamps.)

### CLASSIFIED ADVERTISEMENTS

Advertisements in this section are inserted at the cost of fifteen cents per word for each insertion—name, initials and address each count as one word. Cash should accompany all classified advertisements unless placed by a recognized advertising agency. Not less than ten words are accepted. Advertising for the August, 1938, issue should be received not later than Tuesday, June 7, 1938.

### RADIO

**YOU RADIO MEN WHO WANT TO READ RADIO'S** Liveest Magazine every month and learn about every new development which takes place—in servicing, in new tubes, in foreign developments, in facsimile, in television, in test equipment, read the announcement which appears above on this page. Learn how you can subscribe to **RADIO-CRAFT** and get an invaluable free premium.

### SONG POEMS WANTED

**WANTED ORIGINAL POEMS, SONGS, FOR IMMEDIATE** consideration. Send poems to Colonial Music Publishers, Ltd., Dept. P69, Toronto, Canada.

### To Readers of RADIO-CRAFT

**FREE POSTCARDS MAY BE HAD UPON WRITING TO THE PUBLISHERS**

These post cards make it easy to answer advertisements which appear in **RADIO-CRAFT**, without cutting valuable data which you may wish to save.

Many times manufacturers request you to "clip the coupon" when answering their ads. Often this means destroying part of an article on the reverse page you may need later for reference. Save your **RADIO-CRAFT** issues complete. If you should ever want to sell bound volumes, or certain copies of **RADIO-CRAFT**, the resale value of uncut issues is very much higher than that of mutilated ones. So send for a supply of these free post cards, and use them in answering all **RADIO-CRAFT** advertisers.

## MAN STILL CHAMPION OF THE AIR

Dr. Irving Langmuir Explodes the Story of the Fly that Is Faster than Sound

**D**IGRESSING for the moment from the usual types of scientific investigations which ordinarily occupy his time, an industrial research scientist has exploded—with proofs aplenty in different ways—a fantastic yarn about an insect that flies so fast it arrives before you hear it leave—a fly with a speed of 818 miles an hour (sound travels only 740 miles an hour).

The scientist is Dr. Irving Langmuir, associate director of General Electric's research laboratory and Nobel prize winner; the fly whose reputation he has smashed is the *deer bot-fly*, which repeatedly in recent years—and more and more as time has progressed—has been held up as something which has far outstripped man's puny efforts to become flight-speed champion of the living world. Man's planes hurl themselves through the heavens at a mere rate of hardly more than 400 m.p.h.

Particularly in recent months have there been cartoons and news items referring to the speedy *deer bot-fly* or again simply to the *deer fly*.

Now Dr. Langmuir, writing in the March 11 issue of *Science*, has shown:

(1) The non-streamlined—and really flat-headed—fly at such a speed would encounter a wind pressure against the head of about 8 pounds-per-square-inch, probably enough to crush the fly.  $R=pd^2v^2f$  is his proof.

(2) Power consumption for maintaining a velocity of 818 miles-per-hour would be about one-half horsepower which, for a fly, would be a good deal.

(3) If the fly equals man in efficiency—and it doesn't seem as though the fly can be more efficient than man who himself has a high thermodynamic efficiency—the fly must consume 1.5 times his own weight of food each second to deliver the 370 watts, or nearly half-horsepower of energy, such speed requires.

(4) A piece of solder of roughly the dimensions of the fly can be seen only as a blur if, in a brightly-lighted, white-ceilinged room it is attached to a silk thread and swung so that its speed is 13 miles-per-hour; that at 26 miles-per-hour it is barely visible; that at 43 miles-per-hour it appears only as a faint line and that its direction of flight cannot be told; and that at 64 miles-per-hour the solder "fly" is invisible. (The higher speed attributed to the fly was based on a published report of an entomologist that he had seen the insects fly past him so fast they could be seen only as a blur, and that he estimated their speed as 400 yards a second, or 818 miles-per-hour.)

(5) Laboratory light intensity measurements and calculations also prove that an object the size of the *deer fly* is invisible at speeds of 64 miles-per-hour and above.

(6) A fly striking a person at such a speed would exert a force of 310 pounds, or about 4 tons-per-square-inch, and would penetrate deeply into human flesh—and the first such instance is yet to be reported; and finally—

(7) Dr. Langmuir concludes a speed of 25 miles-per-hour is a reasonable one for the *deer fly*, while 800 miles-per-hour is utterly impossible.

Aviators, then, do not have to hang their heads in shame because they can hardly surpass 400 miles-per-hour with today's airplanes. Nor will they ever have to move over in their courses to give the right-of-way to *deer fly* speedsters.

Incidentally, Dr. Langmuir is a licensed airplane pilot. In September, 1936, in the *Journal of the Aeronautical Sciences*, he also digressed from such subjects as monomolecular layers, dissociation, and such G-E research laboratory subjects to tell, in an article cosigned with Alexander Forbes of the Harvard Medical School, about "Airplane Tracks in the Surface of Stratus Clouds."

In that article he told how he had closely observed such clouds, had cut through them with his airplane, and had swung around and examined the clouds and the changes wrought by the whirling propellers and the cuttings of the wings. He had photographs of his observations.

Still other instances of non-molecular reports of this scientist could be mentioned. For instance, in *Science* for February 11, 1938, Dr. Langmuir wrote on "Surface Motion of Water Induced by Wind," basing his report on observations made from a trans-Atlantic liner!

Please Say That You Saw It in **RADIO-CRAFT**

# LOOKING AHEAD TO TELEVISION OCCUPATIONS

Modern science and invention constantly are creating new occupational opportunities in a rapidly moving world. In the accompanying article a prominent New York City consulting industrial engineer gives a fascinating overview of what may be expected occupationally with the coming development of television. The information is most valuable to counselors of youth who might well heed the warning to proceed with caution!

DR. ALFRED N. GOLDSMITH

**A** STUDY of occupational possibilities in the field of television before that interesting art has made its commercial debut is possibly premature and certainly hazardous. It savors slightly of planning the Panama Canal shortly before the discovery of America. At best, any vocational analysis of the television of the future must be read with several provisos in mind.

In the first place, a normal engineering development of television is assumed. That is, it is taken for granted that technical knowledge of television will increase apace, enabling the practical solution of the remaining engineering problems of television within a reasonable time. If any apparently insuperable obstacles should prevent the engineers from designing equipment meeting the reasonable needs and desires of the future television equipment purchasers, this might upset all calculations. We are all familiar with arts where normal progress has been retarded by dangers or limitations which the engineers have not as yet been able to overcome. There is a slight but nevertheless existent chance that such obstacles might put off the commercial advent and general acceptance of television for some time.

In the second place, a normal economic development of television must be regarded as probable in any analysis of its occupational possibilities. Television transmitting and receiving equipment is elaborate and relatively costly. Television program construction will be more complex and expensive than radio program construction of today. The television art is a comparatively luxurious one. Manifestly, such an art can hardly be introduced rapidly on a large scale in times of marked economic depression nor can it be expected to win public favor under such circumstances.

The television programs will be paid for, under our present system of broadcasting operation, by advertising sponsors in the main. The sponsors will in this way purchase a portion of the purchasing power and general good will of the looking and listening public. But the size of the audience, its purchasing power, and its mood will all influence the extent to which the advertiser can justifiably support television broadcasting. Accordingly, there is an action and reaction between economic conditions and television success. If times are bad, the programs must be restricted which, in turn, affects the public response that justifies the broadcasting of the programs. Only in reasonably good times can this circle of effects be broken advantageously. Accordingly, those contemplating television as a career will watch closely for times of general economic recovery since it is in such times that arts like television can be expected to flourish and to afford opportunities for a multitude of new workers.

Assuming that television comes into its own in the next 5 or 10 years, probably the best way to outline the various occupational opportunities which it will offer, and the requirements of each position, will be to describe the activities of the field in some detail (with the various prospective openings italicized).

## OPPORTUNITIES IN MANUFACTURING

Let us start at the factory where the necessary equipment for television transmission and reception originates.

Here are needed *apparatus engineers* who are

Reprinted from *Occupations, the Vocational Guidance Magazine* for April, 1938. (Copyright 1938.) Published by the National Occupational Conference, New York City.

capable of doing research, development, and design work in that complicated field. These men must be technically trained and well-qualified along conventional radio lines in order to meet the more difficult problems of television. These radio engineers are, in fact, electrical engineers with specialized training in the particular field of communications. In the factory there are also needed *tube engineers* who will handle the similar problems of vacuum-tube and cathode-ray-tube production which are an integral part of the television transmitters and receivers. Some of these men may be university-trained physicists who are prepared to enter the equally complex but more commercial fields of tube research and design. The usual factory personnel will be required for television equipment construction, including *test men, supervisors, production and manufacturing engineers*, and the like.

The qualifications here are similar to those for positions of the same type in other fields except that the manufacturing and test problems are probably more difficult and more rapidly changing than in most other fields, thus demanding a flexible, responsive, and original mind as well as great native energy and determination.

## TRANSMITTING STATION JOBS

Once the television transmitter has been built and shipped, it must be installed in the television transmitting station and thereafter maintained. At this point, an entirely new series of openings will exist. *Television station engineers* will include *field-survey engineers* who will determine the best location for the station and its antenna system and who will study the strength and acceptability of the signals throughout the service range of the station. These men will also furnish the data which will satisfy the governmental authorities that the station is covering its territory with an adequate service in the physical sense. The equipment must be maintained in good condition at all times, and emergencies must be met, and this is the job of the *maintenance staff* of the station. Men of great reliability and prompt resourcefulness are required for this type of work.

The television-station studios will require a staff of their own of considerable size and of wide diversity of tasks. Considering the technical men only for the moment, there will be *lighting experts* who will arrange and control the powerful illumination which floods the sets (scenery) in the studio, and the actors. These men must be skilled electricians capable of handling, shifting, and controlling illumination in any desired fashion. There will be the *microphone or sound men* in the studio who will place and control the microphone supports or booms which hold the microphone close enough to the actors to pick up speech or music, while still keeping the microphone outside of the view of the camera. Here men with steady hands, quick responses, and a cool way of working effectively will be required (particularly in the stress of high-speed operations during the studio performance). In the control rooms of the studio, there will be *sound-control men* and *picture-control men* who will handle respectively the quality of the sound and the picture which is being transmitted. These men will be technically trained, probably as junior engineers, and they must have quick responses, good judgment, and manual skill in getting the picture and sound results which will best please the audience.

Sometimes, the television transmissions will be from sound-motion-picture film which has been previously made. For example, a film news-reel may be transmitted. This requires that there

(Continued on following page)



LOOK ALL YOU LIKE  
COMPARE ALL YOU LIKE

... there is no tube tester value on the market like the NEW

## DYNOPTIMUM TEST

Dependable Tube Checker **\$16.95**  
Model 307  
... and all it costs is

- All these features in one low-priced instrument!
- Tests all types of tubes including OZ4 and other cold cathode rectifiers.
  - Tests all ballast tubes.
  - High sensitivity neon short and leakage test for each individual element
  - Latest improved circuit test tubes at RMA specified voltages and loads as approved by all tube manufacturers.
  - Individual tests of each section of full wave rectifiers, duo diodes and all multi-purpose tubes.
  - 3" square D'Arsonval meter, accurate within 2%.
  - Direct reading, multi-colored dial.
  - Accurate line voltage indication and control.
  - Simplest to operate; unsurpassed workmanship; attractive design.

Also available in combination counter-portable model \$18.95  
See your jobber. Write to Dept. C for catalog.

**RADIO CITY PRODUCTS CO.**  
88 PARK PLACE NEW YORK CITY

BE SURE TO READ  
THE  
**ANNOUNCEMENT**  
WHICH APPEARS ON  
**PAGE 4**  
OF THIS ISSUE

## You need our 1938 Catalog

It illustrates and describes our complete line of

**RACKS • PANELS • CABINETS**

FOR ALL RADIO AND P.A. NEEDS

Write for your Free Copy Today!

Visit Our Exhibit at the RADIO SHOW—Booth No. 204 Bell Street at Stevens Hotel, Chicago, June 8th, 9th, 10th and 11th.

**PAR-METAL PRODUCTS CORP.**

3527 41st St., Long Island City, N. Y.

Please Say That You Saw It in RADIO-CRAFT

# Radio-Craft FREE Swap Column

## LOOKING AHEAD TO TELEVISION OCCUPATIONS

(Continued from preceding page)

shall be projectionists who will handle and project the film on the television pick-up whereby it is sent to the audience. Here too there will be necessary film-sound control men and film-picture control men who will carefully monitor the transmissions.

### CAMERA MEN

The television-camera men will constitute a new profession as well. These men handle the television pick-up or "camera" which is trained on the action and carefully and continuously focused. The reactions of these camera men must be instantaneous, they must work with perfect coordination in groups where several angle-shots of the same scene are to be transmitted, and they must be resourceful and artistic in their pictorial sense. It should be remembered that the television broadcast cannot be altered after it is transmitted. The first transmission to the audience is the last transmission, in general, and there is no opportunity to rectify errors or limitations by a succession of "takes" (as is commonly done in present-day motion-picture production). Accordingly, the job of television-camera men will be exacting and important.

The television-camera men in the studio will be a part of a larger group, for it is clear that the outdoor television pick-ups (or "spot" programs—Editor) will require the services of men of similar qualifications and perhaps as great resourcefulness to meet the multitude of complicated, partly unforeseeable, and sometimes uncontrollable conditions to be encountered in outdoor jobs. The outdoor camera man will necessarily be of somewhat the same type as the present successful newsreel camera man who can meet an emergency promptly and effectively.

Since a fair portion of television programs may be, as stated above, from film, it will be necessary to film program material, recording both picture and sound in the same way as now done by the motion-picture studios and newsreel companies. This will lead to a demand for film camera men, sound recordists, editors, cutters, and other men of the types found in the motion-picture studios of today. The demand in these fields may develop fairly rapidly as the program "hunger" of television broadcasting rapidly increases after its commercial inception.

### TELEVISION SERVICE MEN

Still considering work of primarily technical nature in the television field, it is clear that the television receivers of the future must be installed correctly and kept in good operating condition.

This requires the existence of a good-sized group of television Service Men. Such men must be familiar with the circuits of television receivers, their operation, the testing of the receivers for faults, the location of the faults and their correction, and the best method of installing and maintaining the receiver in the home. The public response to television will depend in some measure on the skill, honesty, and diplomacy of these Service Men, particularly during what may be the more or less difficult early days of commercial exploitation of television.

### RELATED ACTIVITIES

Governmental regulation of radio broadcasting, as at present, will lead to the need for a number of radio supervisors in the various districts of the country charged with the inspection and supervision of the operation of the stations to determine that the Federal regulations are observed and to report on matters of service to the Federal Communications Commission. Further, the staff of the Commission will necessarily include engineering and legal experts in the new field of television. Those interested in entering the Government service may find openings of this sort congenial in the future.

There will necessarily be a considerable number of related or adjunct activities to those mentioned above in related fields. For example, once television broadcasting is carried out on a nation-wide scale, it will be necessary that the programs, in part at least, be syndicated or carried by wire or radio. If wire methods are used, the "coaxial cable" will likely find considerable application. The construction of such cables, their installation, their operation and maintenance will then form one of the fairly extensive activities of the Telephone Company with the creation of

(Continued on page 64)

SPACE in this department is not sold. It is intended solely for the benefit of our readers, who wish to exchange radios, parts, phonographs, cameras, bicycles, sporting goods, books, magazines, etc., without profit.

Since we receive no money for these announcements, we cannot accept responsibility for any statements made by the readers. Use these columns freely. Only one advertisement will be accepted from any reader for any one issue. All transactions MUST be above board. Remember you are using the U. S. mail in all

these transactions and therefore you are bound by the U. S. Postal Laws. Describe everything you offer accurately and without exaggeration. Treat your fellow men the way you wish to be treated.

**NO ADVERTISEMENT TO EXCEED 35 WORDS, INCLUDING NAME AND ADDRESS**

We welcome suggestions that will help to make this department interesting and profitable to RADIO-CRAFT readers. Copy should reach us not later than June 4th for the August, 1938 issue.

**WANTED: 4" x 5" FOLDING** plate camera with plate holders, or 4" x 5" Eastman folding Kodak with plate back and holders. Good condition. Give diaphragm scale numbers. Will trade good radio. Edw. Seymour, 40 Manning Ave., No. Plainfield, N. J.

**WANTED: ISSUES OF THE PROCEEDINGS** prior to 1920. Offer photographic and miscellaneous other supplies. Doane Bernard, Room 1104, 98 Hudson Street, New York City.

**WILL SWAP LOFTIN-WHITE** amplifier with tubes, excellent condition for portable electric drill or other tools. Allan Stuart, 1627 Ponsi St., Fort Lee, N. J.

**WILL SWAP COMPLETE SET OF** golf clubs, all steel shafted, including 3 woods and following irons, No. 2, 5, 7, 9, and putter, with bag, for any standard 1937-8 auto-radio set. N. Gray, 160-22 97th St., Howard Beach, L. I., N. Y.

**WANTED: RADIO PARTS** vintage of 1920—earlier, want Murdock crystal and loose coupler set. Want any type of coherent, Exchange radio or photographic parts, or what you want. R. D. Tilletson, 40 Manning Ave., No. Plainfield, N. J.

**ELECTRIC AUTOMATIC DICK** micrograph; R.F. millimeters; noiseless portable typewriter like new; other items. Want Photographic range finder, Weston exposure meter, or what have you? Write before shipping. Elchberg, 782 West End Ave., New York, N. Y.

**WILL SWAP COMPLETE SELLING** course of National Salesmen's Training Association, consisting of 16 brand new text books (value \$50). Want movie camera of equal value, in absolutely perfect condition. Or what have you? B. N. Lantz, 232 West 67 St., New York City.

**HAVE JANETTE DC-AC CONVERTER**, W. E. ZIEGLER, old G.S.P.'s, RCA Service course, movie projector, many other items. Want kerosene refrigerator, mantle lamp, gas-electric plant, water pump, surveying, photographic instruments. Joseph Loeb, 1380 Merriam Avenue, New York City.

**WILL SWAP COLLECTION OF** radio manufacturers old catalogs and circulars for radio parts. What have you? B. Sunshine, 4408 10th Ave., Brooklyn, N. Y.

**WHAT HAVE YOU TO OFFER** for Midas combination camera and projector, electric motor driven, plus leather case. Brand new, used only once. H. N. Messel, 1627 Ponsi St., W. Fort Lee, N. J.

**HAVE AUDIO TRANSFORMERS**—7 prong analyzer plug and adapters RCA phone use.—National 803 socket. Want 80 meter crystals, crystal headphones, electrical books, course, or? Newell Kelly, 208 Congress Street, East McKeesport, Penna.

**HAVE MODEL 430 TRIPLET** meter tube checker—Model 544A All-Wave Oscillator, with output meter. Want good auto-radio, tubes, Rider manuals. Send list. Radio Service, Box 404, Ashdown, Ark.

**DE VRY PORTABLE MOVING** picture machine with 1000 Watts lamp, motor set with 13 roll film and rewind machine. Exchange. Make offer or what have you? Instruments wanted "any." Wilf. Marler, V.E.2B.J., La Malbale, P. Q., Canada.

**WANTED ONE OF THE BETTER** All-wave broadcast receivers that covers all broadcasts from five meters up with good quality reception. Write giving all particulars. C. Holstein, 246 East 148th St., Bronx, N. Y.

**ALL-STAR SR. 7-TUBE S.W. RECEIVER**—perfect condition, best parts, new tubes, 8" Utah speaker and complete set coils 30 mc. to 540 kc. Trade for Rider's manuals. S. Lyshak, 53 Hadwin Street, Central Falls, R. I.

**HAVE A NUMBER OF 456 KILO-**cycle iron core I.F. coils—will swap. E. J. Kujank, 62 Bruce Street, Galt, Ont., Canada.

**HAVE OLD COPIES RADIO** Broadcast, Popular Radio, Radio News, Radio-Craft, exchange for other copies needed to complete files. Who has copy of Alden-Na-Ald booklet on modernizing tube checkers and analyzers. Pioneer Radio Service, Box 663, Lincoln, Nebr.

**WILL SWAP VELOTRON MICRO-**phones like new for Candid camera. G. Milione, 2342 Crotona Ave., New York City.

**HAVE SUPERIOR ALLMETER**, Ultra Precision Rical Generator, Readrite 430 Tube Tester, Philco radio 602, No. 32 S.C.E. wire, radio tubes, parts, books. Write your needs and offers to T. Wojciechowski, 2880 Fulton Street, Brooklyn, N. Y.

**4 TUBE RGEN. BATTERY RECEIVER** (3 audio). Also max. speaker, 3 p.d.t. switch, (3) 370 mmfd. variable condensers. Trade for battery "trf." camera, or what have you? Howard McElfresh, Marne, Iowa.

**NEON TUBE TRANSFORMER**. Three G. E.—115-15,000 secondary center-tapped, 30 M.A. 11kH reactance will stand direct secondary short! Valued \$7.00 each. Swap for oscillator or instruments. Elroy, 4306 Horrocks Street, Philadelphia, Penna.

**4 TUBE BROADCAST "MAJESTIC"** receiver, dynamic speaker, built in. A.C.-D.C. 110 volts. Exchange for 2 or 3 tube S.W. receiver or transmitter. Also have 1 tube audio oscillator. Albert B. Hartman, 419 91st Street, Brooklyn, N. Y.

**WILL TRADE 4 TUBE RECEIVER**, 1500 stamps in book, small motor, radio course, 67 lessons, and other equipment for receiver or transmitter, or other short wave equipment. B. B. Trine, Sheridan, Oregon.

**HAVE ACME TYPE S.V.E. PORT-**able 35 M.M. projector with 1000 watt lamp and 5 inch lens in A1 condition. Want reflex type camera with F.3.5. lens or 32 watt high gain beam power amplifier with mixing facilities. F. Bosch, 69-02 67th St., Glendale, L. I., N. Y.

**WILL SWAP REMODERNIZED** 304 Dependable Tube Tester for portable typewriter or small electric drill. John H. Lesko, 206 West Pine Street, Mahanoy City, Penna.

**HAVE 250 WATT AND 750 WATT** ball bearing 110 volt AC generators. Practically new. Also Triplet test equipment. Want acetylene welder, printing press, shop tools. J. L. Orysen, Kennan, Wisconsin.

**SWAP & SELL** 10¢

*The Nation's Market Place*



**FREE SWAP ADS FOR YOU**

## SWAP & SELL

is the great, big, new magazine that shows you how to get more than 1000 different articles, such as cameras, rifles, books, magazines, clothing, tools, pets, etc., without having to buy them!  
It runs your own swap ad free!

It prints letters from men and women who seek new friends!

It publishes true experiences from real life!

It tells you how to swap and how to make money!

It helps you get all the things you've always longed for, yet never could afford!

**You NEED a copy to help you get more out of life!**

### NOT SOLD ON NEWSSTANDS

Send only 10c for sample copy, or get all twelve big issues for the coming year—only \$1.00 if you order at once!

### SWAP & SELL

99C HUDSON STREET NEW YORK, N. Y.

**Be Sure to Read**

**the Announcement which appears**

**on Page 60 of this Issue**



## BOOK REVIEWS

**RADIO ENGINEERING**, by Frederick Emmons Terman. (2nd Edition, 1937.) Published by McGraw-Hill Book Co., Inc. Size, 6 x 9 ins., cloth covers, 813 pages, 474 illustrations. Price \$5.50.

"Radio Engineering" in its new 2nd Edition is an eminently successful text, and is practically a new book; over 3/4 of the text has been completely rewritten and more than 2/3 of the illustrations are new. Besides bringing all material up to date, and adding a complete set of problems for each chapter, the author has added a considerable amount of new material which is here presented in print for the first time. In addition, many changes have been made to improve the presentation of various sections.

Each of the 18 chapters in this book is subdivided into 5 to 15 sections. The chapters are titled as follows: The Elements of a System of Radio Communication; Circuit Constants; Properties of Resonant Circuits; Fundamental Properties of Vacuum Tubes; Vacuum-Tube Amplifiers; Vacuum-Tube Amplifiers (Continued); Power Amplifiers; Vacuum-Tube Oscillators; Modulation; Vacuum-Tube Detectors; Sources of Power for Operating Vacuum Tubes; Radio Transmitters; Radio Receivers; Propagation of Waves; Antennas; Radio Aids to Navigation; Television; Sound and Sound Equipment; Appendix A (Formulas for Calculating Inductance, Mutual Inductance, and Capacity).

**DICTIONARY OF RADIO TERMINOLOGY IN THE ENGLISH, GERMAN, FRENCH AND RUSSIAN LANGUAGES**, by A. S. Litvinenko. (1937) Published by Technical Encyclopaedias and Dictionaries, Moscow (available in U.S. from Bookniga). Size, 7 x 10 1/2 ins., cloth covers, 560 pages. Price \$4.00.

Here is a truly monumental work of interest to the advanced technician who may find himself called upon to translate a radio technical term, abbreviation or symbol either from or into the English, French, German or Russian language. This so-called "preliminary" volume of radio terminology has exceptional merit in enabling international standardization interests to make better headway. For those technicians who can use a book of this nature we highly recommend "Dictionary of Radio Terminology in the English, German, French and Russian Languages."

**RADIO IN THE CLASSROOM**, by Margaret Harrison. (1937) Published by Prentice-Hall, Inc. Size, 5 1/2 x 8 ins., cloth covers, 260 pages. Price \$2.50.

Although this book is primarily concerned with the use of radio as a supplementary tool to education it contains a certain amount of technical information regarding radio equipment for the school that will be of interest to the progressive service and sound man who wants to annex a portion of the extensive business available in the field of school radio and sound installations.

Note, however, that this book is mainly designed to aid supervisors, principals and teachers to help make use of programs broadcast throughout the country. The tenor of this book may be visualized by noting the following listings of its chapters: Educational Objectives and the School Radio; Radio Programs Available to Schools; Selection and Classroom Use of Radio Programs; Classroom Activities Related to Radio; Supervision of the School Radio; Radio Receiving Equipment for the School; Radio's Contribution to the Activity Program and the Development of the Units of Classroom Work.

**RADIO AND ELECTRONIC DICTIONARY**, by Howard P. Manly. (New 1938 Edition.) Published by Frederick J. Drake & Co. Size, 6 x 9 ins., cloth covers, 300 pages, 550 illustrations. Price \$2.50.

This long-awaited book is right-up-to-the-minute, with more than 3,800 definitions of the technical words and terms used in all branches

of radio, including aviation, navigation, and industrial control, photoelectricity, photocell applications, sound pictures, public address systems, television, telephotography, electricity and magnetism.

Almost everyone in the radio field at one time or another will probably find this volume useful. It's a radio library "must" book.

**FORTSCHRITTE DER FUNKTECHNIK**. Published by Franckh'sche Verlagschandlung, Stuttgart, Germany. Size, 7 1/4 x 10 ins., 174 pages. Price, approx. 60c.

Written in German, this beautifully-prepared volume is probably the most comprehensive cross-reference to practical German radio technique of any so far published. Every sort of commercial radio equipment is beautifully illustrated; and, insofar as possible, described in technical detail.

The section devoted to vacuum tubes contains an extensive listing of technical characteristics; and tube terminals of German tubes of all types. A second chapter breaks down various circuit arrangements to their fundamental components. An exceptionally interesting chapter is one devoted to antenna coupling circuits of various types. Another unusually interesting chapter is the one devoted to loudspeakers—with emphasis on permanent-magnet types. Sound recording of all types is treated in considerable detail. Various methods of measurement including the use of cathode-ray equipment are described. A chapter of importance to the short-wave experimenter is one devoted to ultra-shortwave technique. A chapter on television brings the reader up-to-date on German developments in this direction. Two pages of diagram symbols introduce the reader to 50 pages of European commercial radio receiver diagrams that will interest designers of equipment for export.

**TECHNICAL MANUAL TT-3**, by Commercial Engineering Section, RCA Radiotron Div., RCA Mfg. Co., Inc. 5 1/2 x 8 1/4 ins., paper covers, 192 pages. Price, 25c.

"Air-Cooled Transmitting Tubes," is the subtitle of this most useful new publication for the transmitter specialist. Note that much of the material contained in this Manual is also of importance to short-wave diathermy technicians. Big value; note Contents:

General Vacuum-Tube Considerations. Generic Tube Types, Transmitting-Tube Installation, Transmitting-Tube Applications, Technical Description of Tube Types, Transmitting-Tube Ratings, Transmitter Design Considerations, Useful Formulas, Transmitting-Tube Charts, Rectifiers and Filters, Circuit Section, Index, Reading List.

**RADIO TUBE DATABOOK**. Published by Raytheon Production Corp. Paper covers, size 4 1/2 x 9 ins. (just pocket size), 200 pages. Price, 25c.

This tube "databook" contains the chief technical data on all tube types—from the oldest to the newest. Prepared as a pocket-size book, it includes a wealth of information on tube applications and uses—maximum ratings, values of essential characteristics and the more important characteristics in operating curves for each active tube.

Much of this information has previously been obtainable only by a limited number of receiver design engineers. Data are given on all tubes that have been at all widely used in the past in receivers and amplifiers that are still handled in the trade as replacements; also on all types announced up to the end of 1937. For completeness there are included the necessary data on resistor, radio receiving, special receiving tubes, and panel lamps.

Literally a treatise on tubes, "Databook" gives definitions of the various tube characteristics and terms, and explanations of how these quantities may be determined from the characteristics curves; simple circuit diagrams showing the essentials of the various sections of a modern radio receiver, including the newest features, and convenient charts for determining the proper values of certain tube circuit constants and operating voltages.

## A NEW NOKOIL

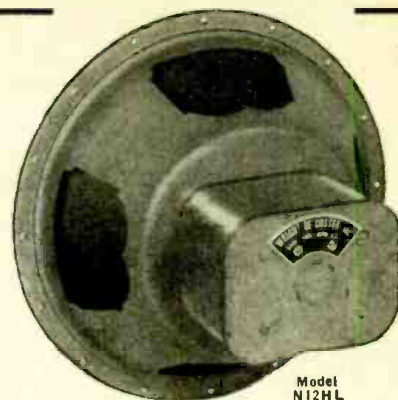

Model N12HL

- 20 Watt-Power Handling Capacity
- Maximum Efficiency
- Outstanding Frequency-Characteristics

Its performance will convince you there is no 12" Permanent Magnet Speaker its equal.

List Price **\$31.00**

Write for our special introductory offer.

Wright-DeCoster Distributors are always anxious to cooperate.

### WRIGHT-DECOSTER, INC.

2251 UNIVERSITY AVE., ST. PAUL, MINN.

Export Dept.: M. Simons & Son Co., New York  
Cable Address: "Simonrice"

Canadian Representatives:  
Wm. F. Kelly Co., 1207 Bay St., Toronto, Ont.  
Taylor & Pearson, Ltd., Edmonton, Alberta

● Everything you need in radio. It's all in this new **RADOLEK RADIO PROFIT GUIDE**. Every repair part for every receiver. Newest radio receivers. Test instruments. Technical books. Special equipment. Leading standard brands. Every item guaranteed. It must be right or we make it right. And everything under one roof. You get what you want promptly, and exactly what you want. Radolek's immense stock, plus Radolek's efficient organization, insures you fastest service. 25,000 service men depend on this service and benefit by Radolek's Radio Profit Guide. It will help you make more money.

----- **RADOLEK** -----

601 W. Randolph, Chicago, Dept. C-19

Send me the 1938 Radolek Radio Profit Guide FREE.

Name .....

Address .....

Service man? Dealer? Experimenter?

Please Say That You Saw It in RADIO-CRAFT

# AMPERITE offers "ADJUSTABLE RESPONSE"

...made possible by THE ACOUSTIC COMPENSATOR

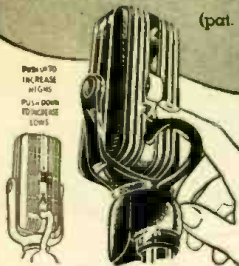

(pat. pend.)  
\*Higher or lower pitch with the same microphone.

With the flip of a finger you can now (1) lower or raise the response of the microphone... (2) adjust the microphone for most desirable response for close talking or distant pickup... (3) adjust the system to any "taste", room condition, or equipment.

MODELS RBHk, RBMk, with Acoustic Compensator. Frequency range 40 to 11000 cps, output, -65 db., complete with switch, cable connector and 25' of cable. \$42.00 LIST

**NEW LOW-PRICED CONTACT "MIKE"**  
Model SKH (hi-imp); SKL (200 ohms) \$12.00 LIST

MODELS RAH-RAL, excellent for speech and music. Reduce feedback. \$22.00 LIST

Write for Complete Illustrated Bulletins and Valuable Sales Helps.

AMPERITE Co. 561 BROADWAY, N. Y. Cable Address: Alkera, New York

AMPERITE Velocity MICROPHONE

## RED HOT SPECIALS!



### BRUNSWICK 6 TUBE

2-6 Volt Battery Console Receiver  
Uses:—5-30 and 1-31 tube or 4-201 A and 1-71-A tubes, 4 gang, 4 tuned currents, single control.

Brand new. Factory sealed cases, size of console, 40x21x14 1/2" —shipping weight, 70—no C.O.D. \$3.95 Express or Freight only. AD-6669 No C.O.D. Shipments



### 13 WATT BEAM POWER AMPLIFIER KIT

A beautifully designed amplifier conservatively rated at 13 watts (in push pull) 2 stages, one 6J7G high gain stage and a pair of the Beam Power 6V6G tubes using a 82 type rectifier for

AD-110-125 v., 80 cps. may be used for crystal, velocity or ribbon mike and magnetic or crystal phono pick-up—complete kit with all necessary parts (less tubes) with pictorial wiring diagram and drilled chassis size 10 1/2 x 7 1/2" —shipping weight, 10 lbs.

AD-112-A, 10 watt amplifier kit complete less tubes. Wiring and testing. \$4.49 \$2.00 extra.

AD-112-B, 13 watt amplifier kit complete less tubes. Wiring and testing. \$4.95 \$2.00 extra. No C.O.D. shipments.

KIT OF TUBES, 1-82, 1-6J7G, 2-6V6G, \$2.75

### KOLSTER 7 1/2-20 WATT

Public Address Amplifier Transmitter Power Supply

This 210 or 250 tube amplifier unit with 12 1/2" 25 Watt speaker, brand new in factory sealed cases, costing over \$100.00, ready to use as amplifier and tapped power supply. Conversion diagram for making 20 Watt High Gain amplifier furnished free. Shipping wgt 80 lbs. No C.O.D. shipments.



Send for our new money saving catalogue. Containing over 1000 red hot radio items at bargain prices.

UNITED RADIO CO.

Dept. R—Drawer 1000 NEWARK, N. J.

## LOOKING AHEAD TO TELEVISION OCCUPATIONS

(Continued from page 62)

a corresponding television-cable staff. To the extent that radio-relay methods of syndicating network programs are used in the television field, there will have to be established a radio-relay staff, consisting of engineers, maintenance men and the like to keep the connecting links in perfect operating condition.

### OPPORTUNITIES FOR WRITERS

Leaving the field of technical television occupations, it is evident that there may exist a bewildering multiplicity of opportunities for persons of the necessary originality, energy, and application.

Programs cannot be started until there are authors. Since the television lookers may be practically insatiable in their demands for program material, it will tax the inventiveness and strength of the authors to the utmost to supply the steady flow of interesting and usable material for the television programs of the future. The material prepared by the authors will, in some instances, require revision or adaptation by rewrite men or script men who will have to be high-speed literary lights of special ability to meet the instant and considerable demands of the program staff.

### DIRECTORS, ACTORS, MUSICIANS

The casting and production of the programs will require still another group of specialists.

For instance, there will be needed a number of persons, including, of course, directors who will know how to build up, rehearse, and present television programs. These men can be drawn partly from the legitimate or "little" stage and the motion-picture studios. In part, however, they will have to be trained at dramatic schools which may be established for the purpose.

At this point there is reached what may be the most serious television demand of all, namely, the demand for qualified actors. By "actors" are meant all those appearing before the television camera and microphone including musicians, announcers, dramatic and comedy characters, commentators, vaudeville actors, lecturers, interviewers, and the like.

It must be remembered that we do not as yet know just what are the desirable qualifications for a television actor. The nature and psychology of the home audience, the limitations and opportunities of home presentations, the technical capabilities and restrictions of the television screen, and the general economic problems of television will all affect the suitability of a given person as a prospective television actor. Since only a minor fraction of the aspirants will please the radio public, it follows that a great number of applicants will be necessary to meet the situation. However, the career of a television actor will be appealing to many and, in spite of the long odds against the individual, it is likely that there will be intense competition from a horde of applicants for these openings. Probably those who have been adequately trained and have had successful experience in somewhat similar fields will stand the best chance of successfully entering this new field.

A considerable number of studio openings will necessarily exist in the television field, for example, jobs for carpenters, scenic painters, set artists or designers, costume experts, wardrobe mistresses, make-up men, historical-research specialists (who will see to it that no historical inconsistencies or inaccuracies are present in the performance) and the like. Such openings will increase only rather slowly in number as time goes on, since it is likely that the full development of the television field as a branch of the art of the stage will take a generation or more because of the many and novel problems which are involved.

### CAUTION!

One final word may be in order in the form of advice to the person who is thinking of entering the field of television. Don't push and run—walk; and watch where you are going. Speed in rushing into the field will not be nearly so helpful as first knowing where your abilities lie, cultivating those abilities by training in fields similar to television, and then everlastingly sticking to the job of perfecting your talents and their application once you have entered the television field. Remember that television success will come rather as the result of a prolonged marathon of effort than from a brief gold-rush of enthusiasm.

## Index to advertisers

<b>A</b>	
Aerovox Corporation.....	57
Allied Radio Corporation.....	57
American Television Institute, Inc.....	Back Cover
Amperite Corporation.....	61, 48
Amplifier Co. of America.....	52
Amy, Aceves & King, Inc.....	55
Arrow Sales Company.....	52
<b>B</b>	
Bj-Phone Reproducer Labs.....	46
Brush Development Company.....	46
Burstein-Applebee Company.....	54
<b>C</b>	
Capitol Radio Engineering Inst.....	50
Central Radio Laboratories.....	40
Classified Section.....	60
Continental Carbon, Inc.....	59
Coyne Electrical School.....	3
<b>G</b>	
Grenpark Company.....	44
<b>M</b>	
Hammarlund Mfg. Company.....	42
Hudson Specialties Co.....	43
Hygrade Sylvania Corp.....	47
<b>L</b>	
Lancaster, Allwin & Rommel.....	56
Lincoln Engineering School.....	56
<b>M</b>	
Miles Reproducer Company.....	48
Million Radio & Tel. Labs.....	46
Modell's.....	56
Moto-Scoot Mfg. Company.....	40
<b>N</b>	
National Plans Institute.....	54
National Radio Institute.....	71
National Schools.....	46
National Union Radio Corp.....	41
<b>O</b>	
D. W. Onan & Sons.....	52
<b>P</b>	
Par-Metal Products Corp.....	61
Precision Apparatus Corp.....	48
<b>R</b>	
Radio Circular Company.....	42
Radio City Products Company.....	61
Radio Publications.....	56
Radio & Technical Publ. Co.....	59
Radio Training Association.....	41
Radolek Company.....	63
RCA Institutes, Inc.....	52
RCA Manufacturing Co.....	Inside Front Cover
Readrite Meter Works.....	55
Reliable Radio Company.....	44
Remington Rand, Inc.....	50
John F. Rilder.....	52
<b>S</b>	
Scientific Diathermy Corp.....	48
Solar Mfg. Company.....	46
Sprayberry Academy of Radio.....	53
Superior Instruments Co.....	39
Supreme Instruments Corp.....	43
Supreme Publications.....	52
Swap & Sell.....	62
<b>T</b>	
Technifax.....	42
Test Equipment Co. of America.....	45
William A. Thomas Co.....	48
Triplett Elect. Instr. Co.....	51
<b>U</b>	
United Radio Company.....	64
Utah Radio Products Co.....	49
<b>W</b>	
Wellworth Trading Co.....	50, 54
Weston Elect. Instr. Co.....	Inside Back Cover
Wholesale Radio Service Co.....	52
John Wiley & Sons.....	53
Wright-DeCoster, Inc.....	63

(While every precaution is taken to insure accuracy, we cannot guarantee against the possibility of an occasional change or omission in the preparation of this index.)

# Follow the Crowd...

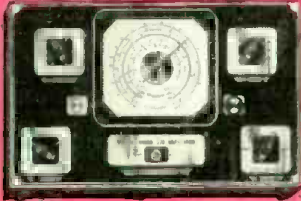

WESTON Model 776  
Oscillator



WESTON Model 773  
Counter Tube Checker  
(also available in portable type)



WESTON Model 772  
Super Sensitive Analyzer

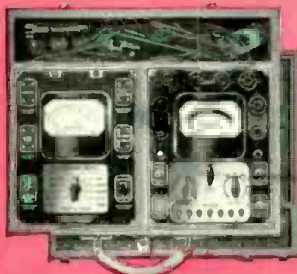

WESTON Model 775  
Serviset

## WESTON Radio Instruments

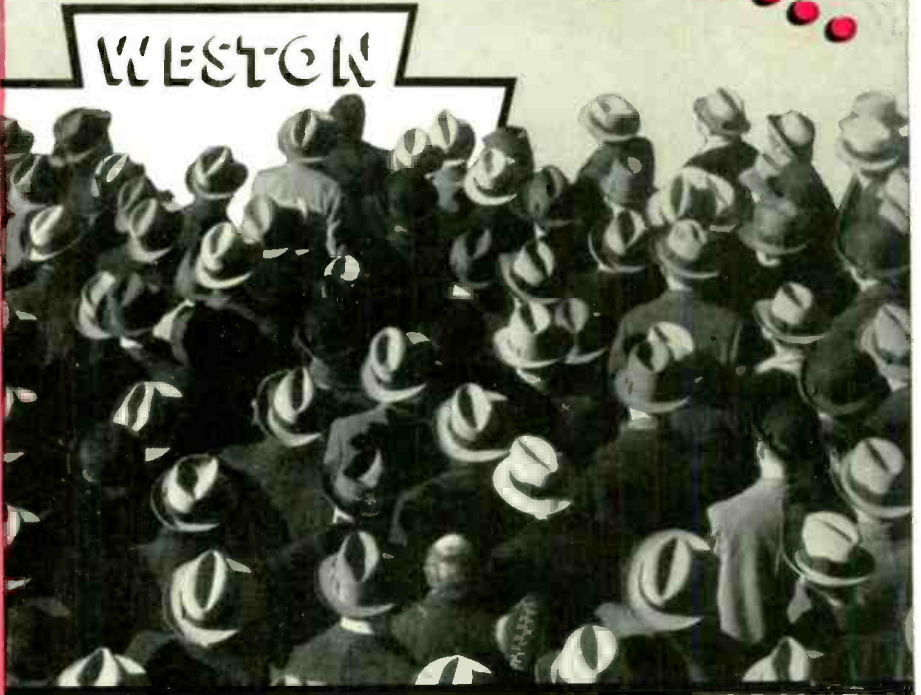

## AT CHICAGO

Don't fail to visit the WESTON Booth at the Radio Trade Show, Stevens Hotel, Chicago, June 8th to 11th. (Booth No. 109-111 Marconi Boulevard.)

**SEE** the very latest in WESTON test equipment . . . take this opportunity to examine the equipment inside and out and *see for yourself* why WESTON equipment leads in accuracy, dependability and length of service.

**GET** full particulars about the 50th Anniversary announcement WESTON is making at the Show in celebrating a half-century of instrument leadership . . . an announcement which presents an unusual opportunity to every serviceman.

If you are unable to attend the Show, however, full particulars on the "50th Anniversary Announcement," and on all WESTON test equipment, will be mailed to you. Just return the coupon today.

**RETURN THE  
COUPON IF  
YOU CAN'T  
ATTEND**

Weston Electrical Instrument Corporation  
599 Frelinghuysen Ave., Newark, N. J.

Send the "50th Anniversary Announcement," and literature on WESTON Instruments.

Name \_\_\_\_\_

Address \_\_\_\_\_

City \_\_\_\_\_ State \_\_\_\_\_

# Put YOURSELF IN THIS PICTURE

**HE'S ALL SET  
FOR A  
CAREER IN  
TELEVISION  
and  
Good Paying  
POSITIONS  
IN THESE  
FIELDS!**

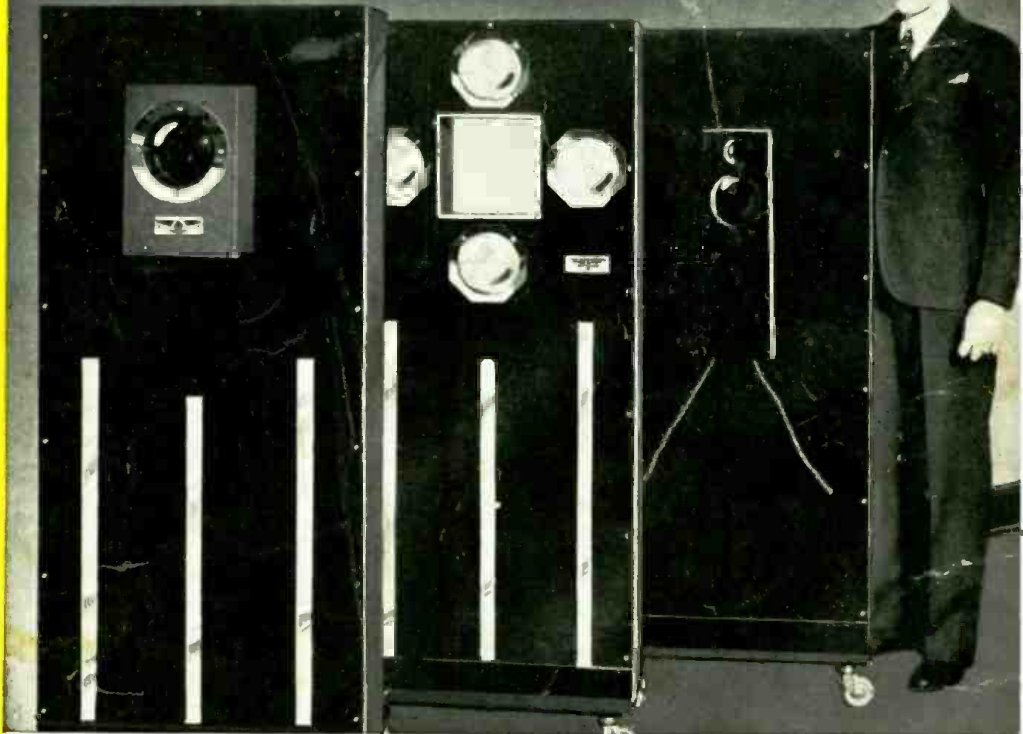

- ★ TELEVISION ENGINEERING
  - ★ RADIO STATION OPERATOR
  - ★ RADIO ENGINEERING
  - ★ SOUND CAMERA TECHNICIAN
  - ★ PUBLIC ADDRESS TECHNICIAN
  - ★ RADIO FACTORY EXPERT
  - ★ TELEVISION TROUBLE-SHOOTER
  - ★ MOTION PICTURE OPERATOR
  - ★ ELECTRICIAN
- and many others!*

## Read What H. L. Newton Says About A.T.I.

"Not only did I get the equipment I expected, but considerably more. I am proud of my A.T.I. Television Transmitter and Receiver, and the professional quality of the materials used. I have already received offers for this equipment I have constructed which will pay me more than I have put in the entire training. I enrolled while in the U. S. Navy and studied the A.T.I. Training in my spare time. My friends were impressed with each new shipment, and the excellent texts. This new method of studying with such elaborate apparatus gave me a real practical knowledge of Radio and Television, and I say that A.T.I. offers any man who wants to get into Television the greatest value for his investment." H. L. Newton, 175 Indiana Ave., Huron, South Dakota.

### Television Men Will Be Needed Soon!

Television is already commercial in England. When it is launched here, Executives know that thousands of jobs will be opened: thousands of TRAINED men will be needed. Be ready to step into a TELEVISION JOB. Now is the time to prepare . . . don't wait until the field is crowded. Get in on the ground floor: first . . . get the better jobs and the highest salaries.

### Practical Television Training

A.T.I. Training prepares you for good paying jobs as a Television Engineer, Radio Station Operator, Laboratory Technician, Radio-Electronic Engineer, Sound Camera Technician, Public Address Engineer, Electrician and many other fascinating, profitable positions. A.T.I. Training qualifies you during the first few months to take your RADIO TELEPHONE FIRST CLASS GOVERNMENT LICENSE EXAMINATION and get into a good paying job in the radio field while completing your television instruction. A Radio Servicing Course is also included.

### You Learn By Actual Experience

The A.T.I. method is new, startlingly different. No dull, hard-to-understand monotonous texts. We train you as you never before dreamed you could be trained . . . you get ACTUAL EXPERIENCE with YOUR OWN TELEVISION APPARATUS just like on the real job. With your A.T.I. Television Equipment you can make over 350 amazing, interesting experiments right in your own home. You can produce your own Television programs for a local audience . . . transmitting and receiving the faces of your friends. You can build complete Television Transmission and Reception Systems. You can make hundreds of experiments and comparison tests that show you the phenomena of Television and Radio in a quick, simple, fascinating way . . . much easier to understand than just mere words in a book. All the Illustrated Equipment included with training . . . AT NO EXTRA COST.

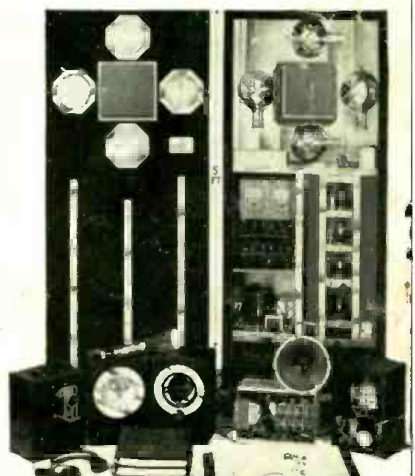

### Costs No More . . . Yet Definitely Better

Mail the coupon for FREE books containing complete information about A.T.I. training . . . photographs, facts about jobs, salaries, how to earn expenses while training, how we assist graduates in the field. Tells the complete story. No obligation.

*A.T.I. Training with Complete Equipment is Available on Amazingly Low Easy Monthly Payments*

## AMERICAN TELEVISION INSTITUTE

433 E. Erie St., Dept. RC-738, Chicago, Ill.

Gentlemen: Please send me your free book on Television and literature describing A.T.I. Training. It is understood that this is FREE. No obligation in any way.

Name  Age   
Address



**GET THE REAL *Inside* FACTS ON  
TELEVISION**